

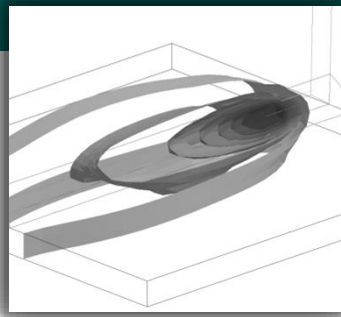

Möglichkeiten in LS-DYNA für die Simulation von Schweissprozessen und Wärmebehandlung

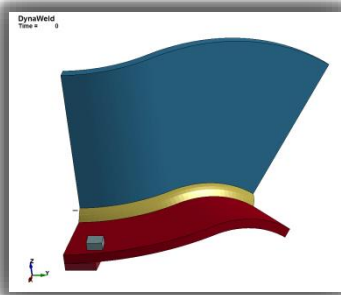

Bernd Hochholdinger (DYNAmore Swiss GmbH)
Thomas Klöppel (DYNAmore GmbH)



Welding simulation: What do we need?

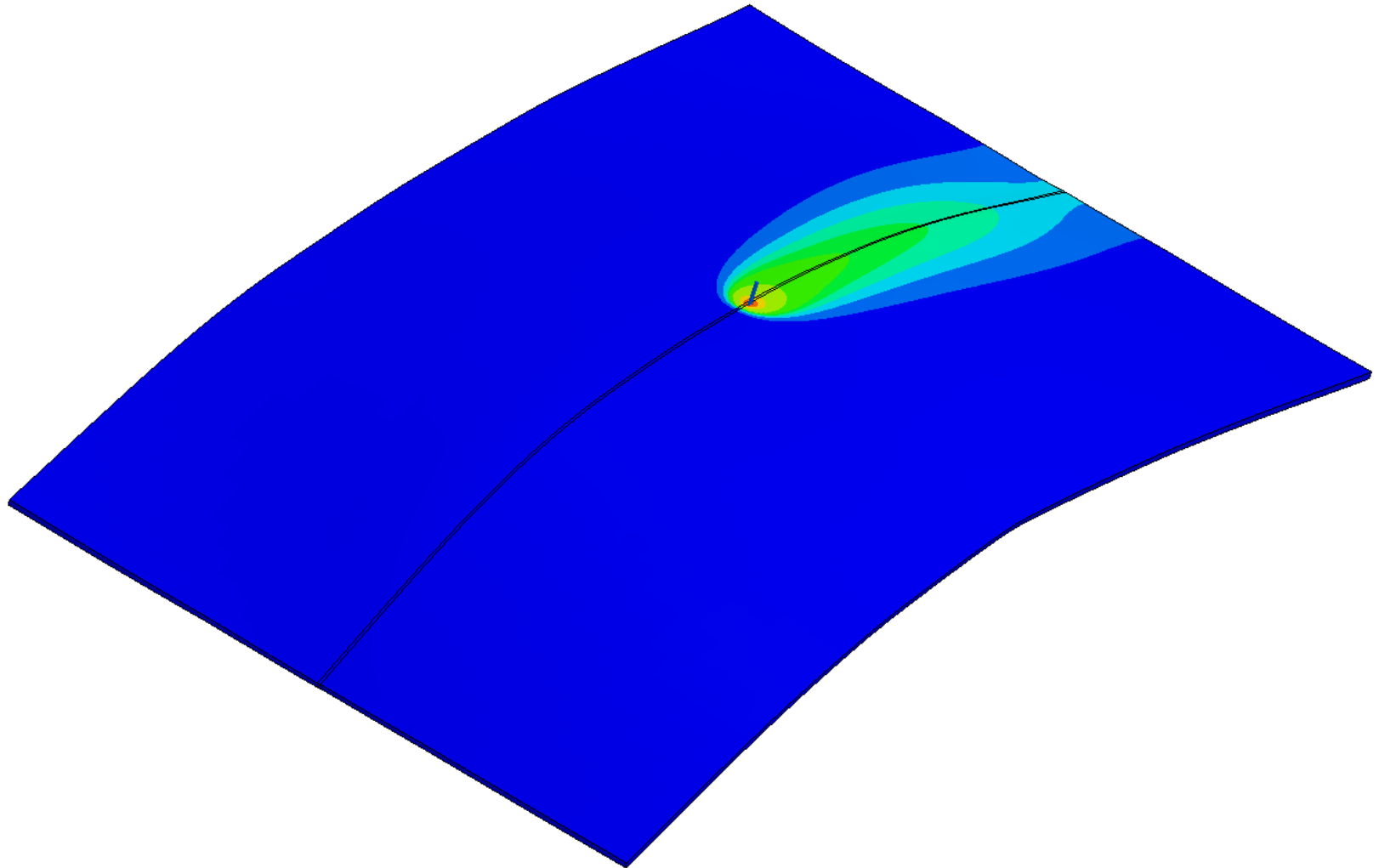

Welding simulation: What do we need?

- Finite element model
 - Geometry
 - Initial conditions (temperatures, stresses & strains)
 - Boundary conditions (thermal & mechanical)
- Coupling of thermal and mechanical problem
- Heat source (welding torch):
 - Geometry and power of the heat source
 - Movement of the heat source
- Material modeling
 - Distinction between **inactive** and **active** state of the material in the weld seam
 - Thermal and mechanical material parameters are **temperature dependent**
 - **Annealing** effects have to be considered
 - Material should be able to account for the **microstructure** of the alloy
 - **Phase changes** in heating and cooling
 - Transformation induced **strains**



Finite Element Model

Geometry

- Mesh of parts and weld seam
- The mesh can be merged together using coincident nodes or with a tied contact with thermal properties.
- All weld passes are modeled from the beginning.

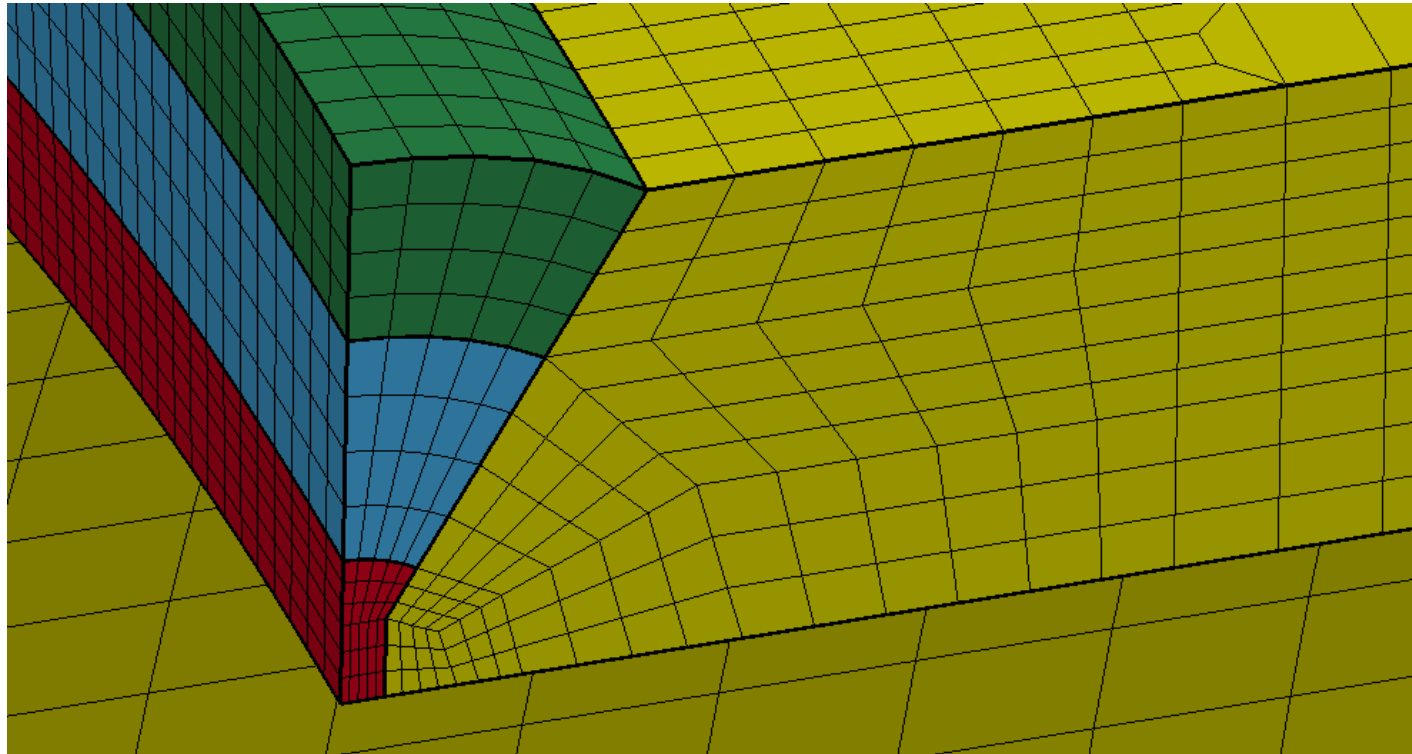

Initial conditions: consideration of manufacturing process

- if no initial conditions are defined, LS-DYNA will assign it to be zero
- properties of the finished part in general depend on the manufacturing chain
- Tooling has to be compensated for springback and shape distortions which occur in the fabrication chain

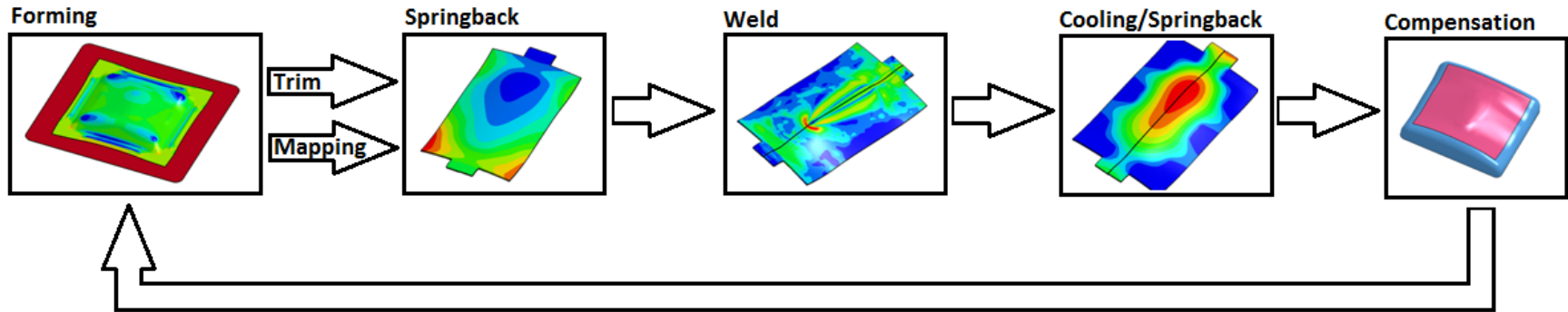

- Numerical simulations of the complete process chain necessary to predict finished geometry and properties
- The individual stages pose very different requirements on the numerical solver

LS-PrePost: Mapping from shell to solid elements

- Shells after forming

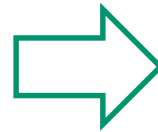
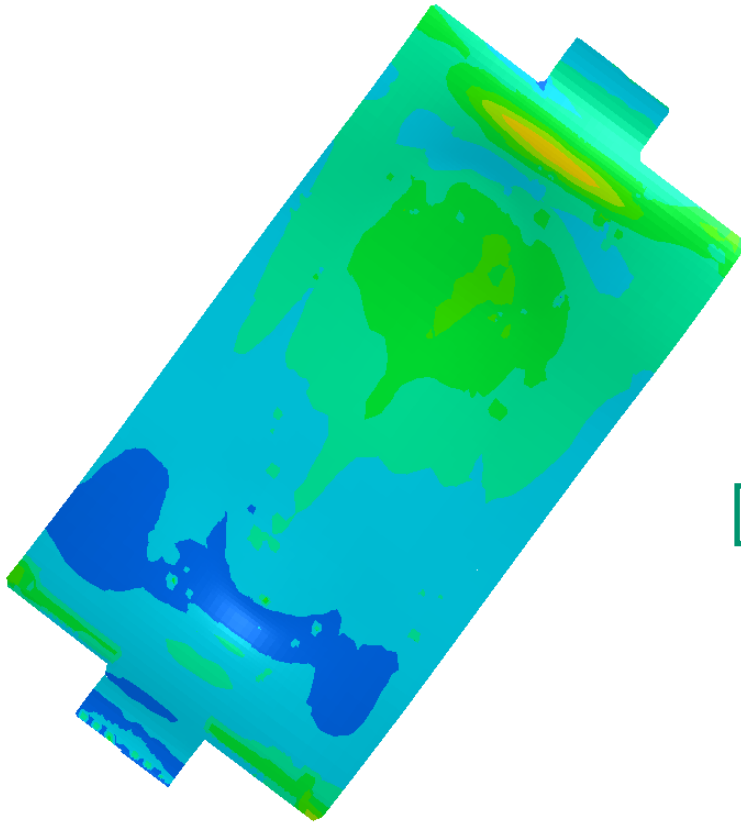

- Solids before welding

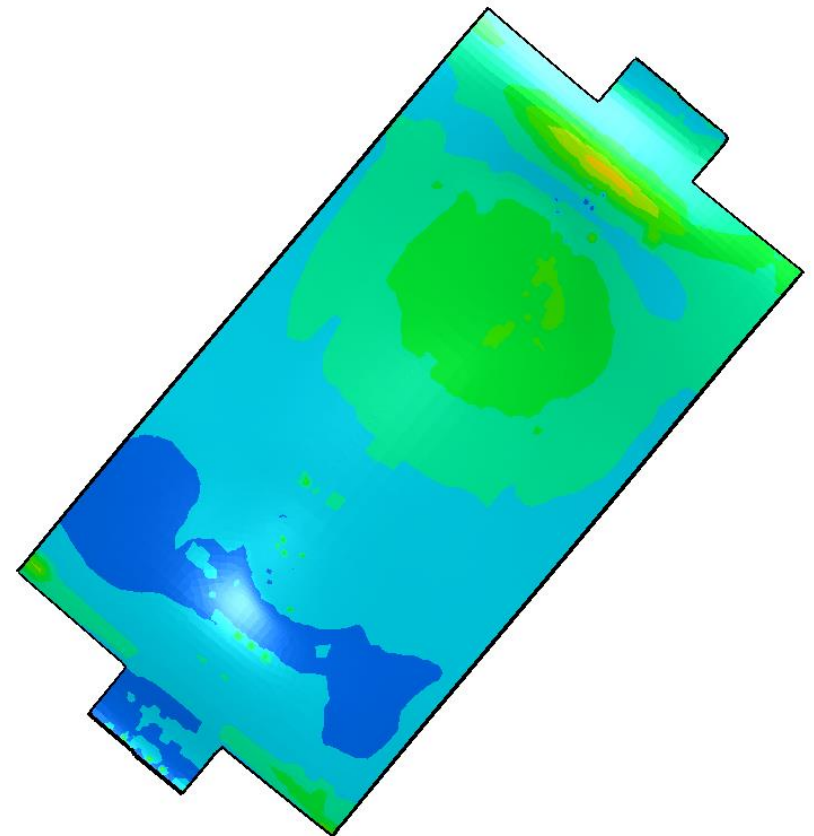

Welding simulation

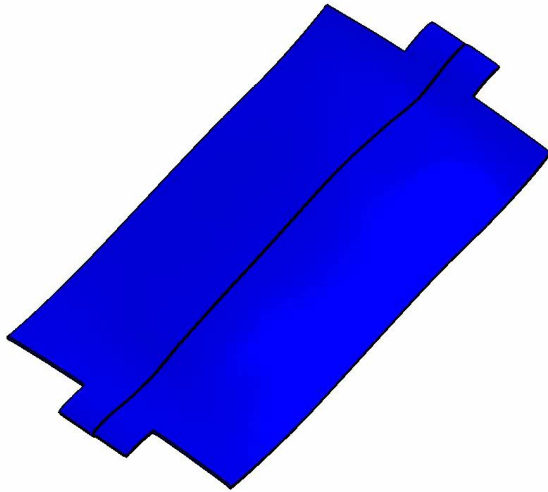

temperature

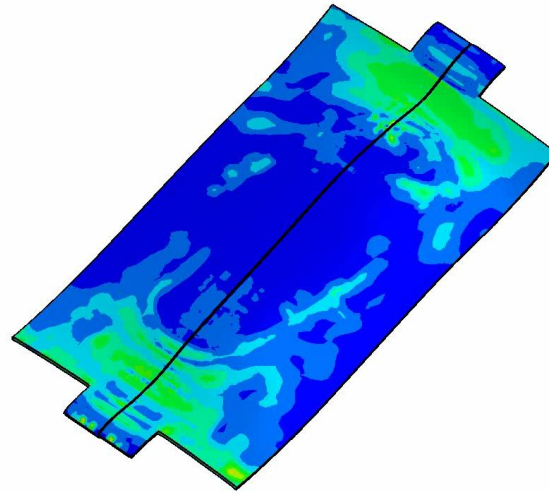

von Mises stress

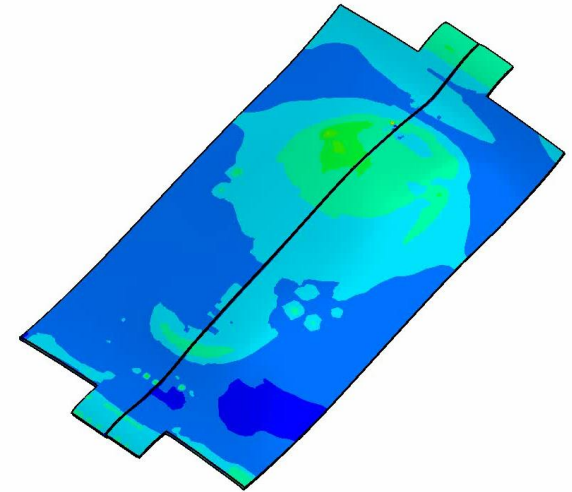

effective plastic strain

Manufacturing process chain including laser welds

Laser Welding
Time = 0
Contours of Temperature
min=293, at node# 1760
max=293, at node# 1760
max displacement factor=10

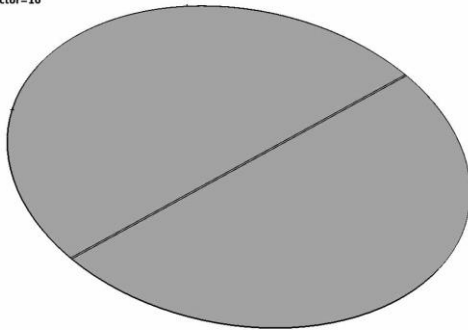

displacement scaled 10-times

Fringe Levels
1.773e+03
1.673e+03
1.573e+03
1.473e+03
1.373e+03
1.273e+03
1.173e+03
1.073e+03
9.730e+02
8.730e+02
7.730e+02
6.730e+02
5.730e+02
4.730e+02
3.730e+02



www.loose.at

Laser Welding
Time = 1015.1
Contours of Z-displacement
min=-5.77562, at node# 503
max=1.15873, at node# 6212
max displacement factor=5

z-displacement

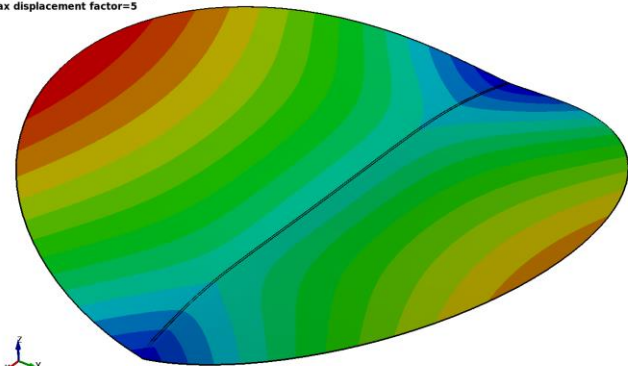

Fringe Levels
1.159e+00
6.634e-01
1.681e-01
-3.272e-01
-8.225e-01
-1.318e+00
-1.813e+00
-2.308e+00
-2.804e+00
-3.299e+00
-3.794e+00
-4.290e+00
-4.785e+00
-5.280e+00
-5.776e+00

CUP
Time = 0
Contours of Effective Stress (v-m)
reference shell surface
min=0, at elem# 6476
max=501.519, at elem# 5285

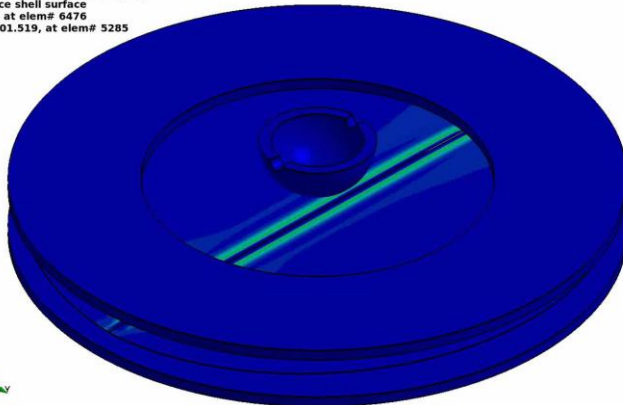

Fringe Levels
1.000e+03
9.500e+02
9.000e+02
8.500e+02
8.000e+02
7.500e+02
7.000e+02
6.500e+02
6.000e+02
5.500e+02
5.000e+02
4.500e+02
4.000e+02
3.500e+02
3.000e+02
2.500e+02
2.000e+02
1.500e+02
1.000e+02
5.000e+01
0.000e+00



www.loose.at

CUP
Time = 1
Contours of % Thickness Reduction- based on cup and strain
min=-21.1098, at elem# 1638
max=44.7195, at elem# 4653

thinning

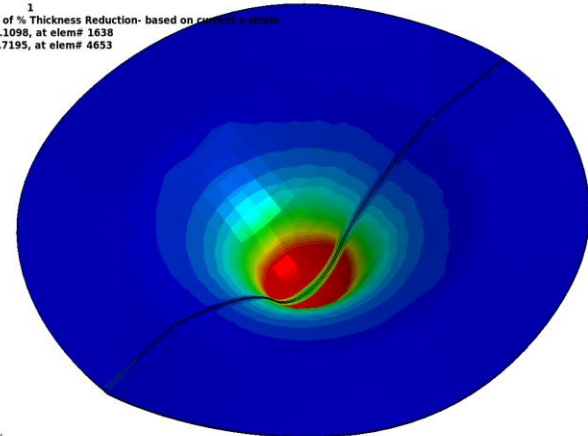

Fringe Levels
4.000e+01
3.800e+01
3.600e+01
3.400e+01
3.200e+01
3.000e+01
2.800e+01
2.600e+01
2.400e+01
2.200e+01
2.000e+01
1.800e+01
1.600e+01
1.400e+01
1.200e+01
1.000e+01
8.000e+00
6.000e+00
4.000e+00
2.000e+00
0.000e+00

Thermal initial and boundary conditions

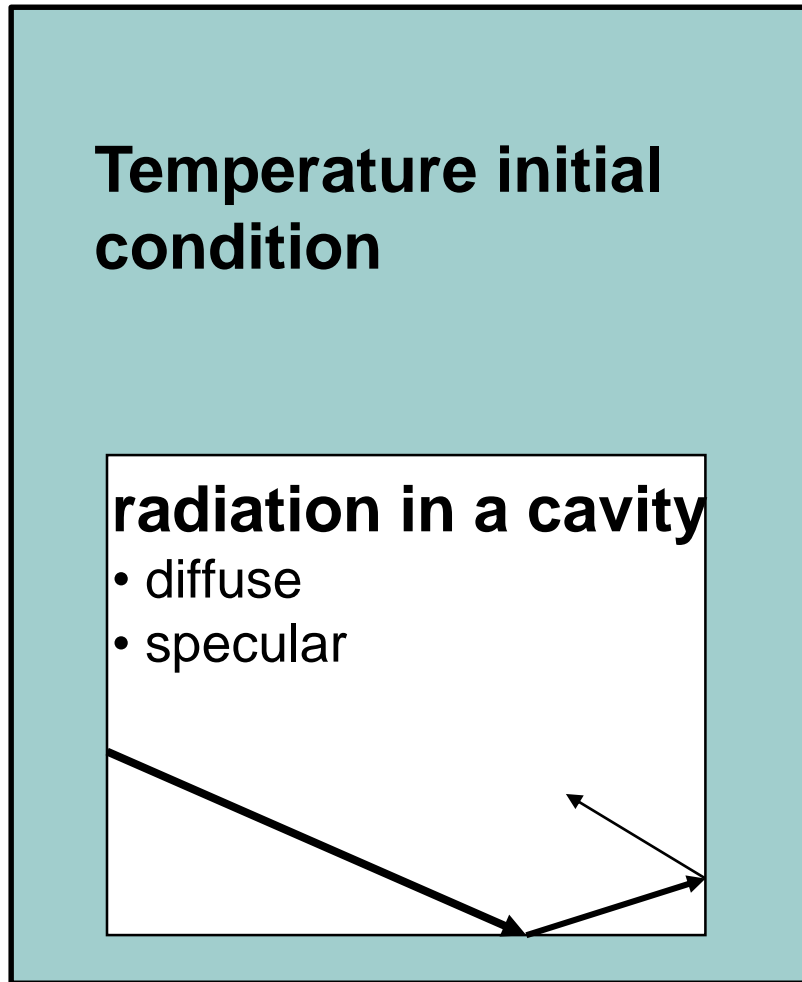

Temperature initial condition

radiation in a cavity

- diffuse
- specular

Boundary Conditions

← temperature = $f(\text{time})$

↔ convection $q = hA(T - T_\infty)$
 $h = f(\text{time}, T_{film} = 0.5(T + T_\infty))$
 $T_\infty = f(\text{time})$

↔ radiation $q = \sigma \epsilon F A (T^4 - T_\infty^4)$
 $h = \sigma \epsilon F = f(\text{time}, T)$
 $T_\infty = f(\text{time})$

↔ flux = $f(\text{time}, T)$



Thermo-mechanical coupling

Thermo-Mechanical Coupling

- Solvers are connected in a staggered solution scheme
 - Typical applications: welding simulation, hot stamping

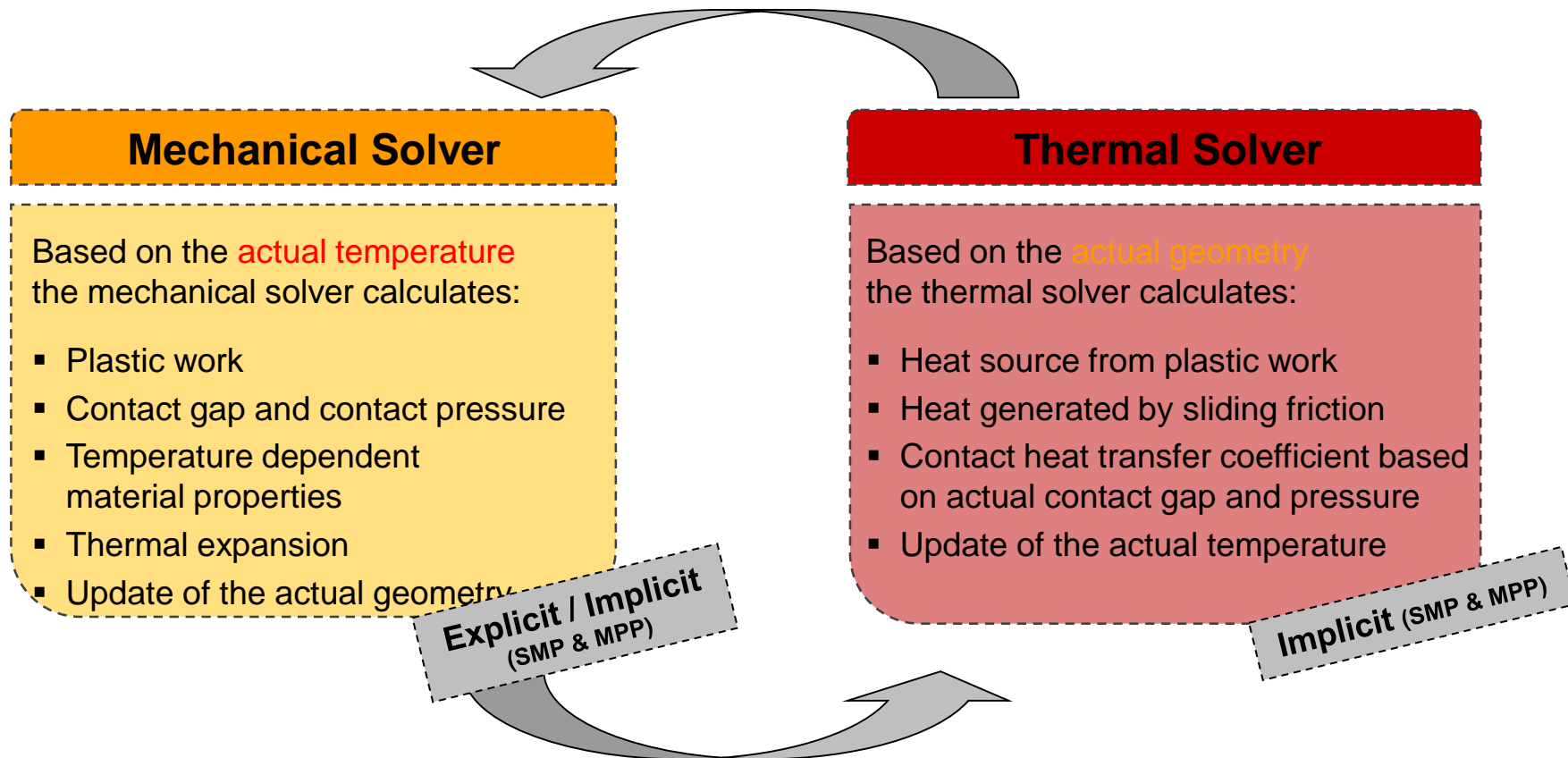

Thermo-Mechanical Coupling

Mechanical Problem

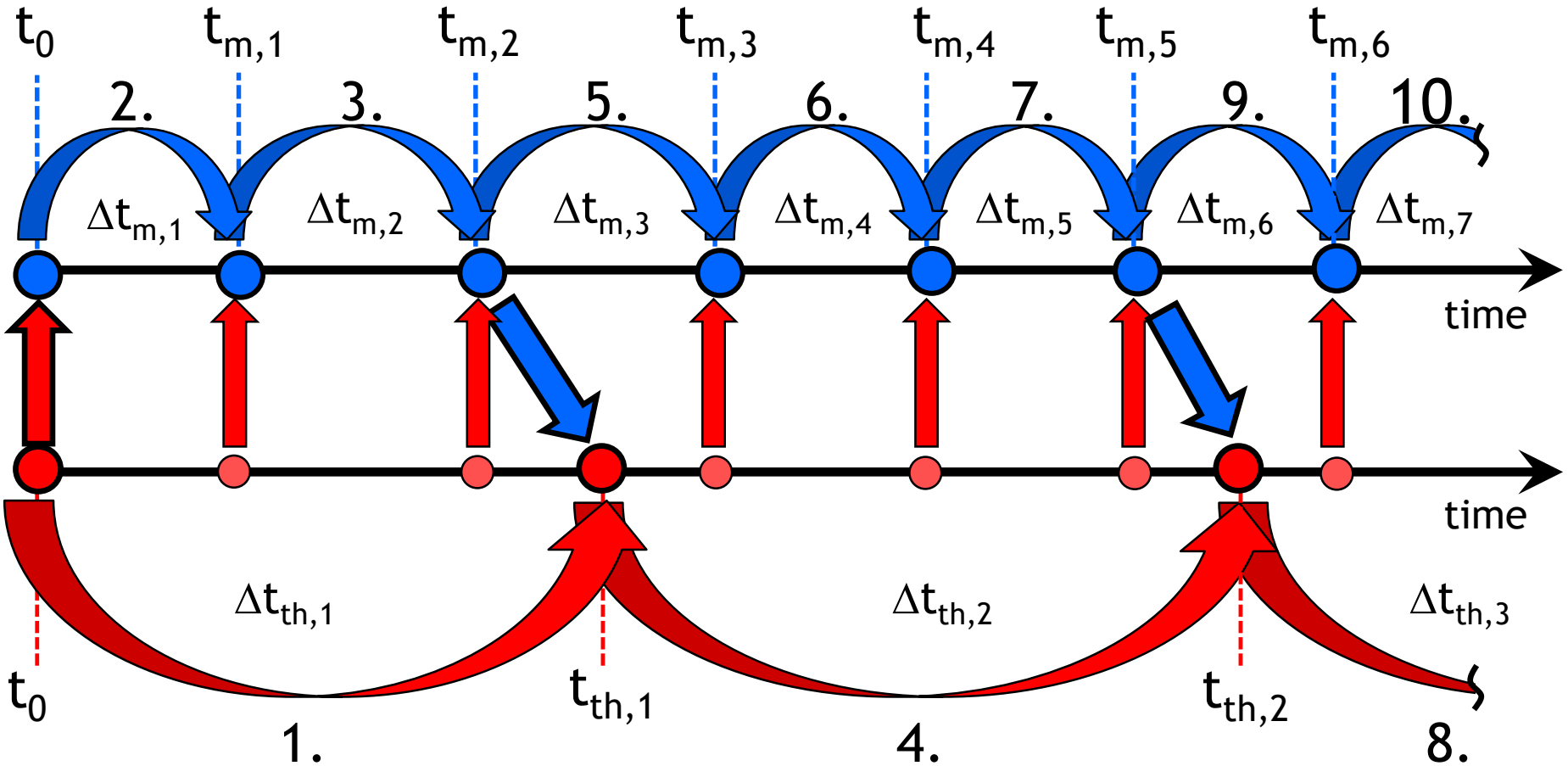

Thermal Problem

Thermal coupling effects

- Conversion of sliding friction energy into heat
 - Heat is distributed equally between contact surfaces
 - Energy calculation with

$$W_{fric} = \mu F_N d$$

- Dissipation of plastic work into heat
 - Commonly 90 - 95% of plastic work is converted
 - Heat calculation using

$$W_{pl} = \rho c_p \Delta T = \eta \int_{\varepsilon_{pl}} \sigma^y d\varepsilon_{pl}$$

- Thermal contact with heat transfer coefficient

- heat transfer in gap

$$h_{gap} = \frac{k}{L_{gap}} + f_{rad} (T + T_{\infty})(T^2 + T_{\infty}^2)$$

- Heat transfer coefficient may depend on contact pressure, temperature of slave and master, ...

CONVERSION OF FRICTION TO HEAT

Contours of Temperature
min=1e-06, at node 80
max=1e-06, at node 90

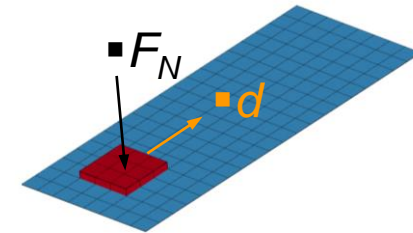

UPSETTING COUPLED

Contours of Temperature
min=20, at node 1
max=20, at node 1

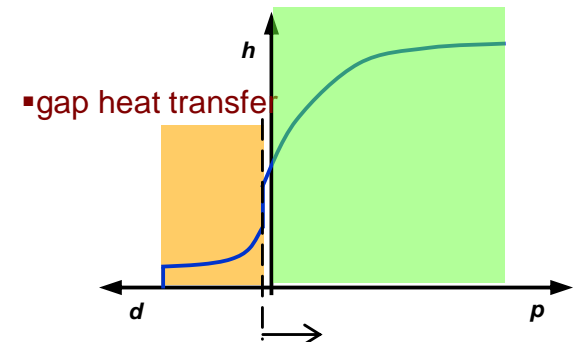
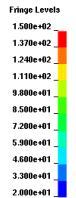
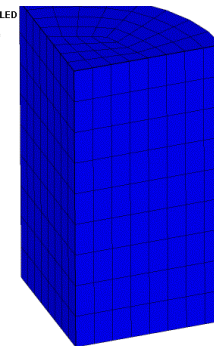



Heat Sources

Goldak double ellipsoid heat source

- Double ellipsoidal power density distribution proposed in [Goldak2005]

$$q = \frac{6\sqrt{3}FQ}{\pi\sqrt{\pi abc}} \exp\left(\frac{-3x^2}{a^2}\right) \exp\left(\frac{-3y^2}{b^2}\right) \exp\left(\frac{-3z^2}{c^2}\right)$$

q = weld source power density

(x, y, z) = coordinates of point p in weld material

$$F = \begin{cases} F_f & \text{if point } p \text{ is in front of beam} \\ F_r & \text{if point } p \text{ is behind beam} \end{cases}$$

$$c = \begin{cases} c_f & \text{if point } p \text{ is in front of beam} \\ c_r & \text{if point } p \text{ is behind beam} \end{cases}$$

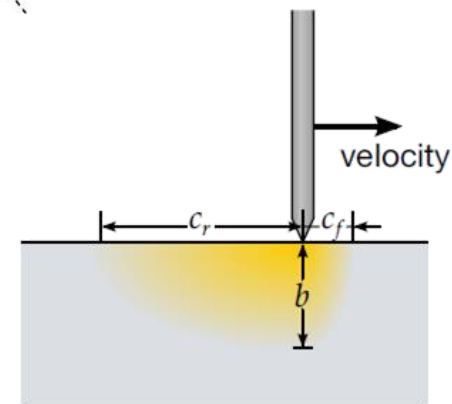
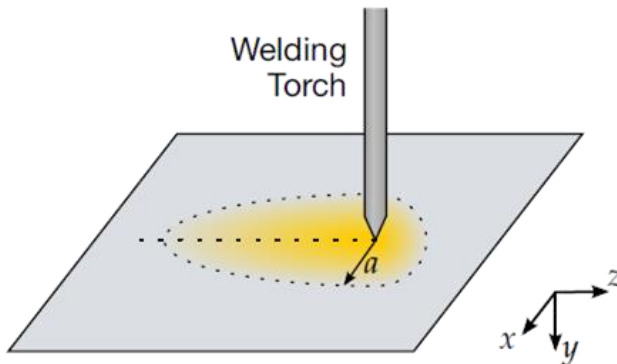
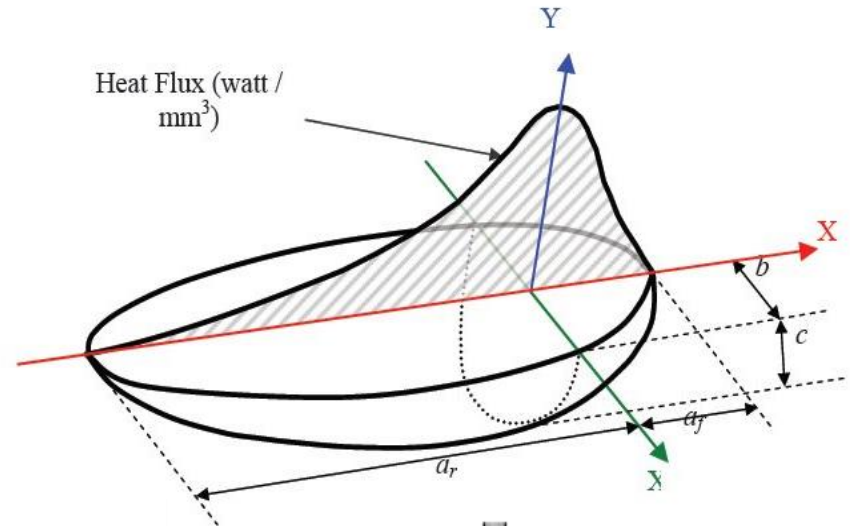

Movement of the heat source - example

LS-DYNA keyword deck by LS-PrePost

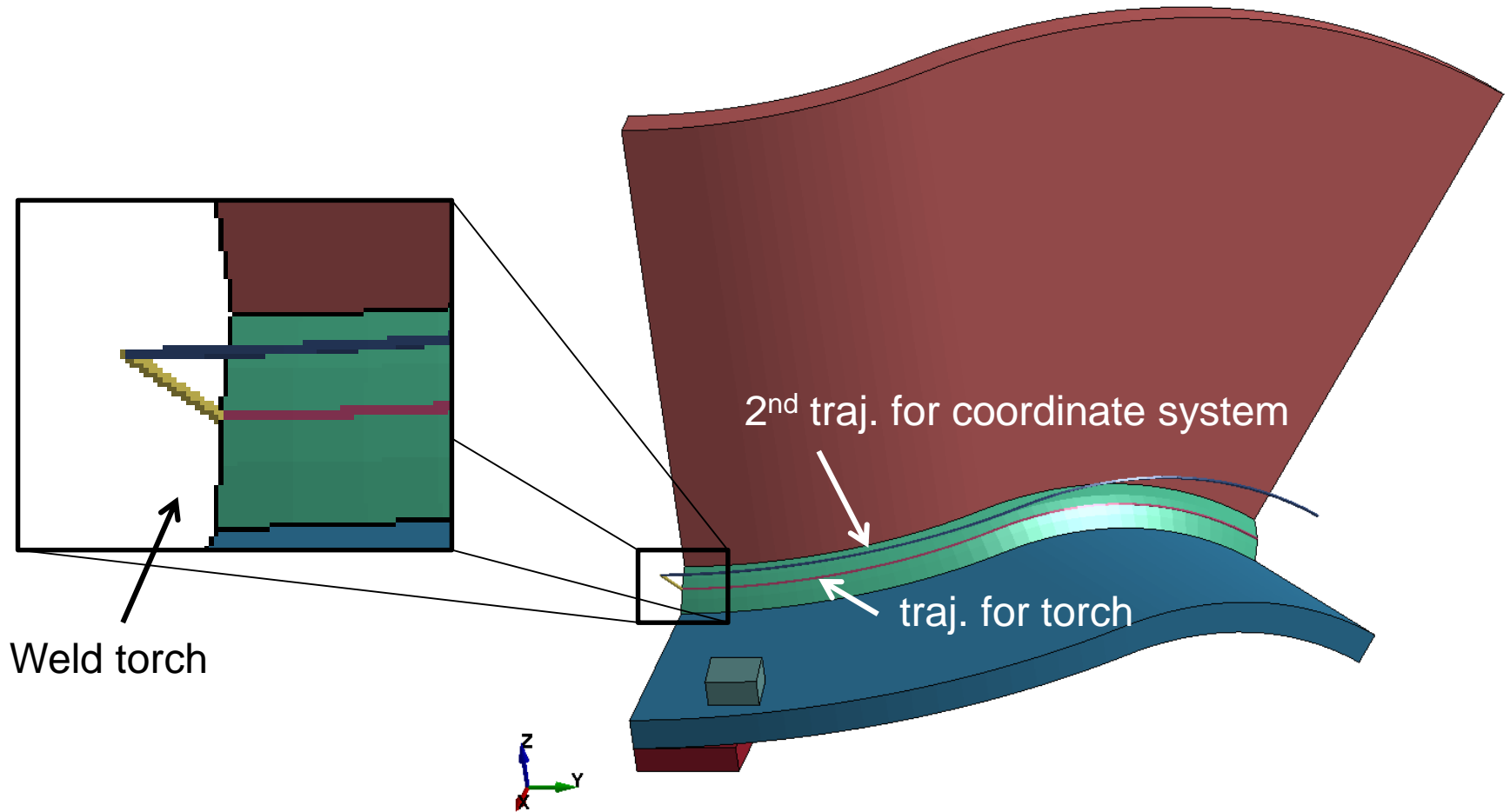

Movement of the heat source - example

DynaWeld

Time = 21.67

Contours of Temperature, middle

min=292.734, at node# 9823

max=3303.61, at node# 9607

Fringe Levels

3.000e+03

2.729e+03

2.459e+03

2.188e+03

1.917e+03

1.647e+03

1.376e+03

1.105e+03

8.344e+02

5.637e+02

2.930e+02

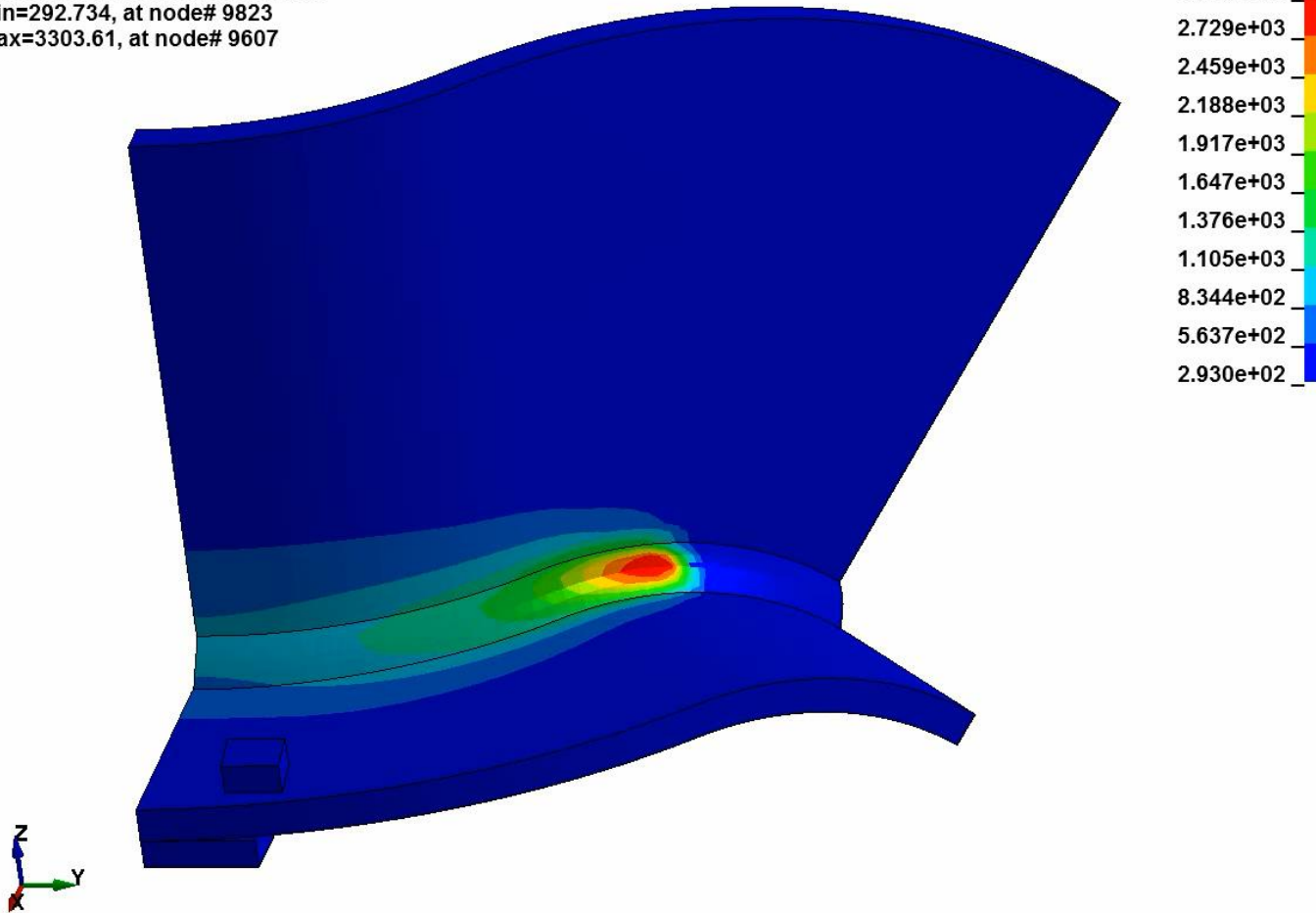

Discussion of the standard Goldak heat source

- Beam motion allows defining the translation and rotation of the heat source
- For previously deformed or curved structures, the description of the heat source is NOT straight-forward
- Movement of the part has to be compensated for
- The incremental heating when using the Goldak heat source leads to element distortion when a too large timestep is used.
- The mechanical solver is needed to move the heat source even though this should be solvable using only the thermal solver.

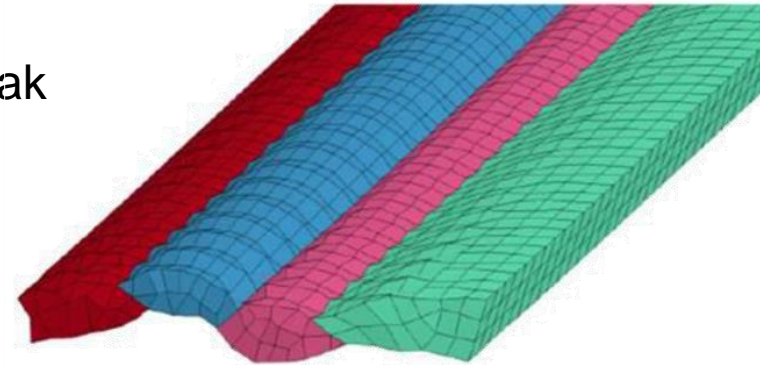
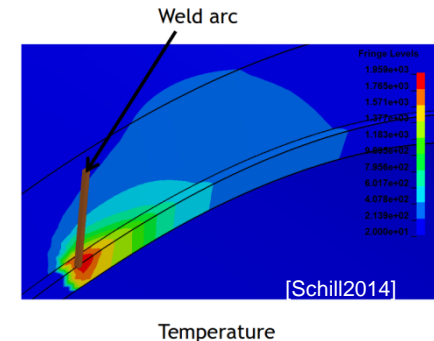

A new heat source approach

- Define heat source and movement within one definition
- New possibilities to define weld path:
 - The heat source follows a prescribed velocity along a node path (*SET_NODE)
 - The heat source is perpendicular to surface (*SET_SEGMENT)
- The weld path is continuously updated
- No need to include the mechanical solver

```
*SET_NODE_LIST
```

```
1
```

```
11861,11877,11893,11909,11925,11941
```

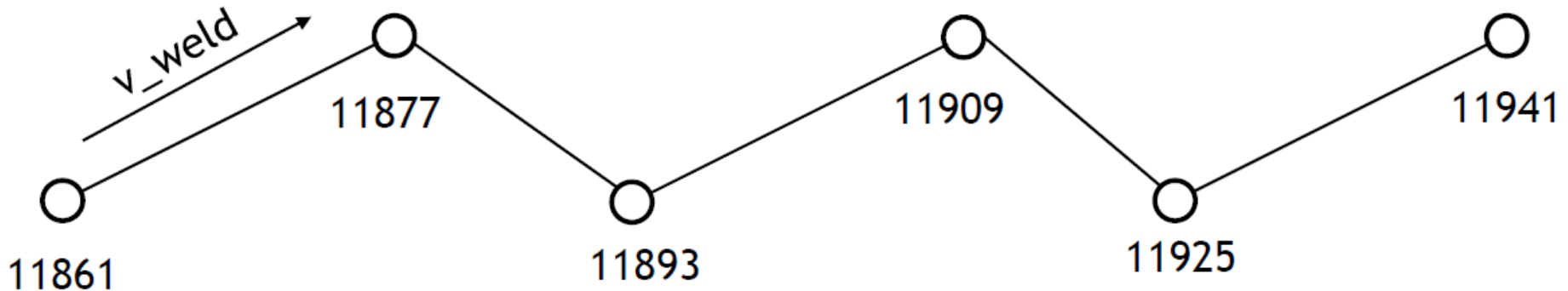

A new heat source approach

- Use “sub-timesteps” for integration of heat source

Weld source evaluated at thermal timesteps

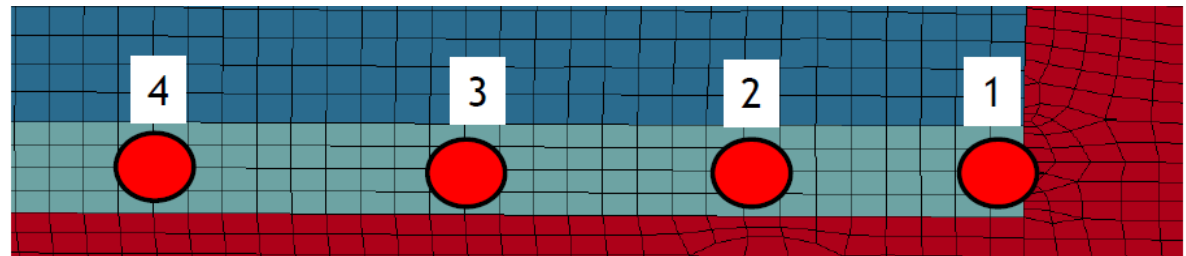

Weld source integrated between thermal time steps

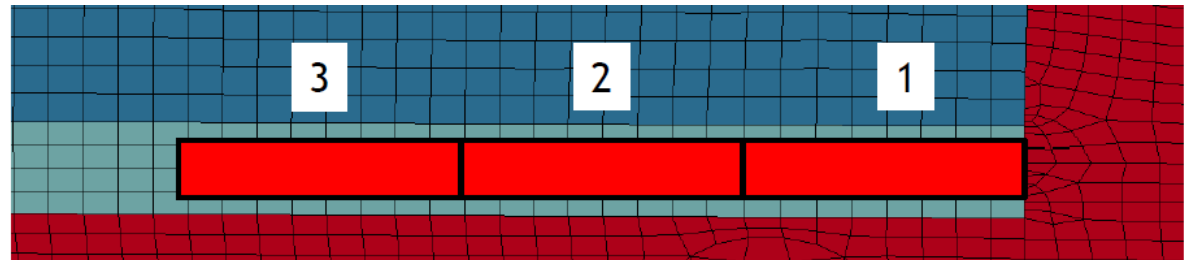

A new heat source approach

- More options for geometry of energy rate density distribution
 - EQ.1. Goldak-type heat source
 - EQ.2. double ellipsoidal heat source with constant density
 - EQ.3. double conical heat source with constant density
 - EQ.4. conical heat source

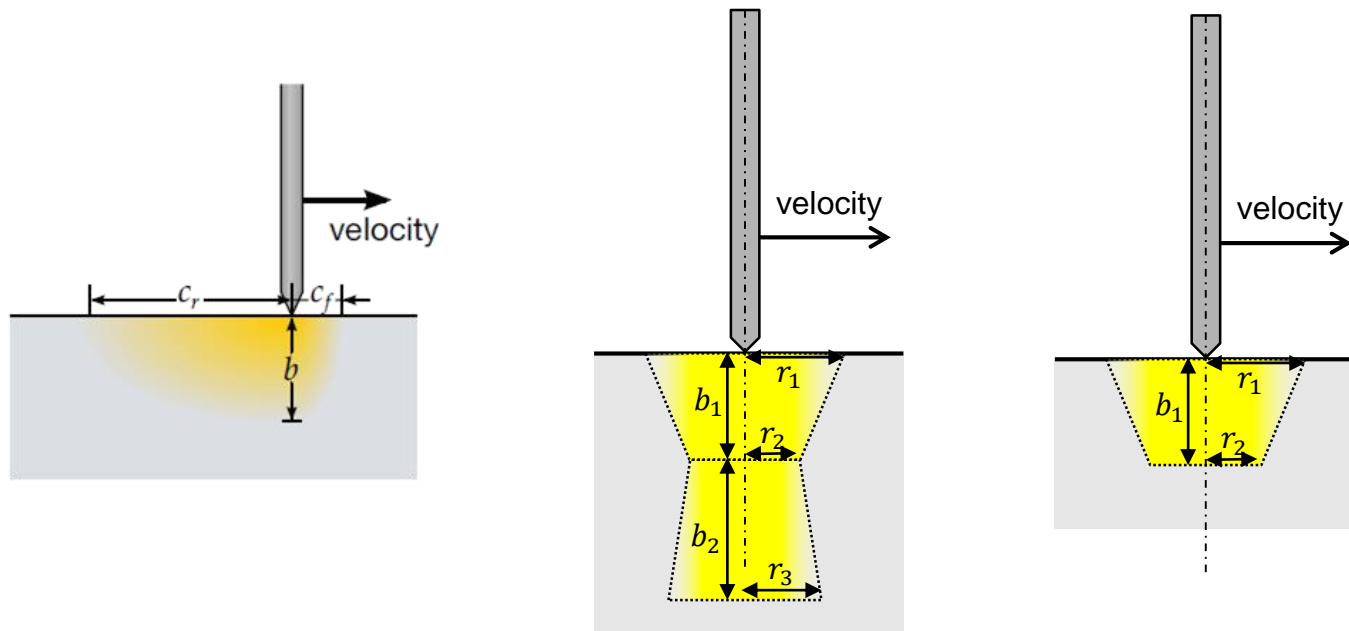

Example

- Welding on a circular trajectory
 - Thermal-only analysis with a large time step

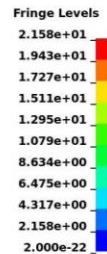
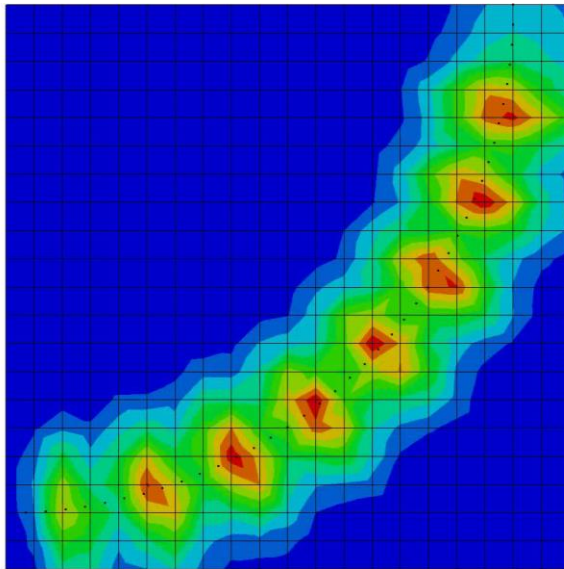

temperature field, NCYC = 1

temperature field, with 10 subimesteps

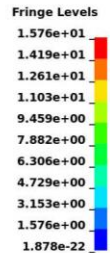
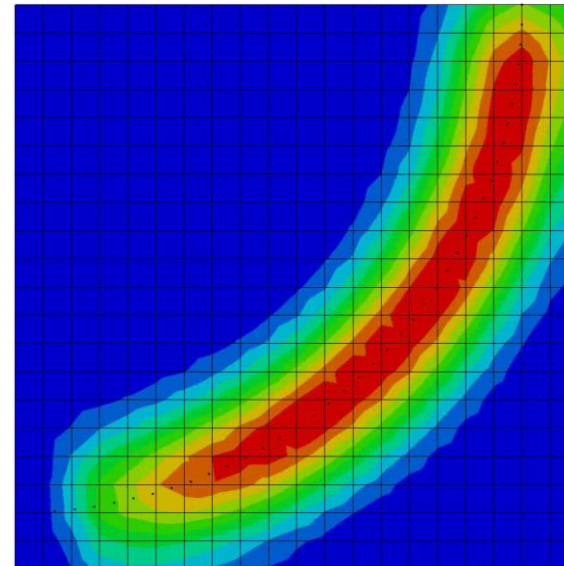

Example: curved T-Joint

- Welding of a three-dimensionally curved T-Joint
 - Coupled analysis
 - Weld source direction defined with a segment set

LS-DYNA keyword deck by LS-PrePost
Time = 25.232
Contours of Temperature
min=292.992, at node# 8837
max=1557.72, at node# 9687

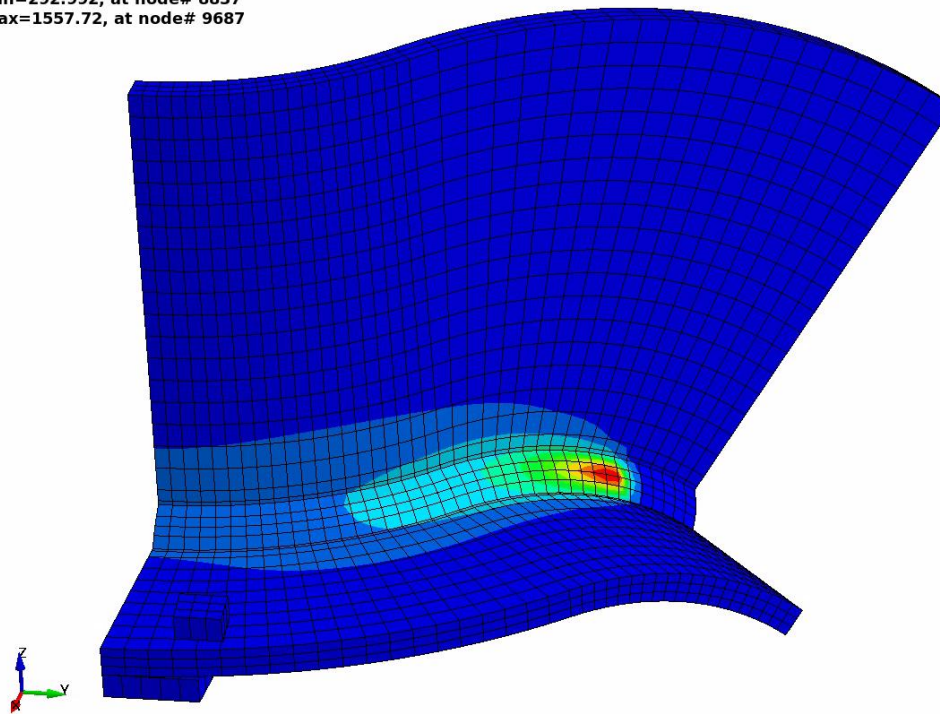

Fringe Levels

1.500e+03
1.379e+03
1.259e+03
1.138e+03
1.017e+03
8.965e+02
7.758e+02
6.551e+02
5.344e+02
4.137e+02
2.930e+02

Example: curved T-Joint

- New approach is also applicable to thermal thick shells
- Three-dimensional curved T-Joint, thermal-only analysis

LS-DYNA keyword deck by LS-PrePost
Time = 0

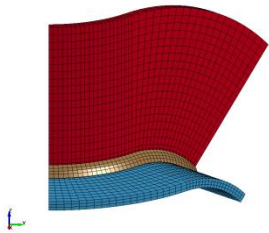

Solids

LS-DYNA keyword deck by LS-PrePost
Time = 0

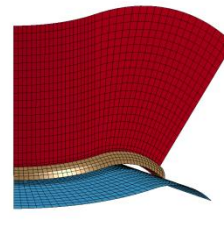

Solids and shells

LS-DYNA keyword deck by LS-PrePost
Time = 0.99484
Contours of Temperature, outer
min=19.9881, at node# 9540
max=153.564, at node# 9357

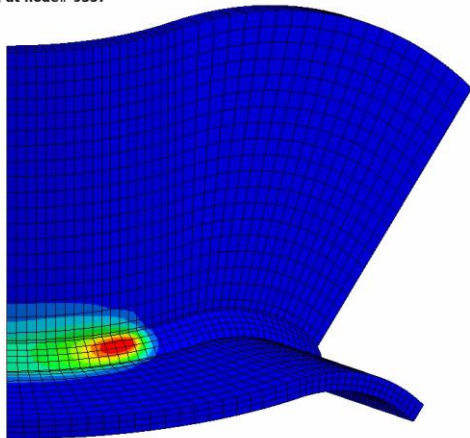

BC on all solids

LS-DYNA keyword deck by LS-PrePost
Time = 0.99484
Contours of Temperature, outer
min=19.9777, at node# 9535
max=123.47, at node# 9373

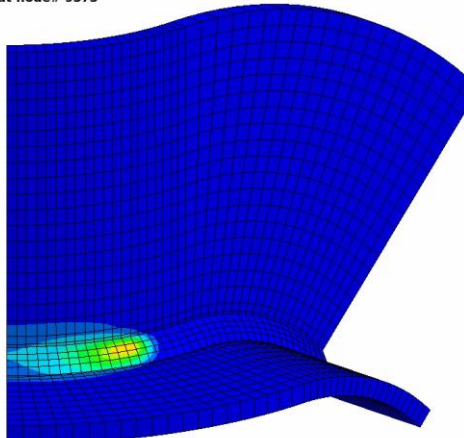

BC on solids only

LS-DYNA keyword deck by LS-PrePost
Time = 0.99484
Contours of Temperature, outer
min=19.9634, at node# 9535
max=154.901, at node# 9357

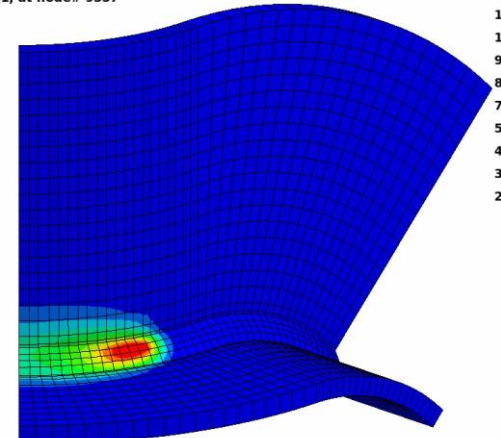

BC on solids and shells

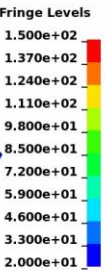

Heat sources with arbitrary shape

- In some cases the pre-defined heat sources are not suitable
- *LOAD_HEAT_GENERATION_OPTION might be useful

	1	2	3	4	5	6	7	8
Card 1	SID	LCID	CMULT	WBLCID	CBLCID	TBLCID		

- LCID accepts a function id, that returns $heat(t, x, y, z)$
- *DEFINE_FUNCTION
 - Define arithmetic expressions involving a combination of independent variables and other functions
 - Function name must be unique (`heat` for heat generation)
 - Can be referenced in other functions
 - C-type or FORTRAN-style code is possible

*LOAD_HEAT_GENERATION_OPTION

■ Example: Define moving (along x) spherical heat source

*LOAD_HEAT_GENERATION_SET

```
1001      1001      1.0      0      0      0
```

*DEFINE_FUNCTION

```
1001
```

```
float heat(float time, float x, float y, float z)
```

```
{ float xl,r1,f;
```

```
xl=x-xt(time);
```

```
if (xl**2+y**2+z**2>=1) f=0;
```

```
else f= sqrt(1- xl**2+y**2+z**2);
```

```
return f;}
```

*DEFINE_FUNCTION

```
4001
```

```
float xt(float time)
```

```
{ float f = 10*time;
```

```
return f;}
```

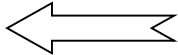
 x distance from center (reference)

 No heat generation outside sphere

 Spherical heat source

 Motion along x-axis with v=10

*LOAD_HEAT_GENERATION_OPTION

■ Example:

Temperature fields for a Goldak and a double cone-shaped heat source

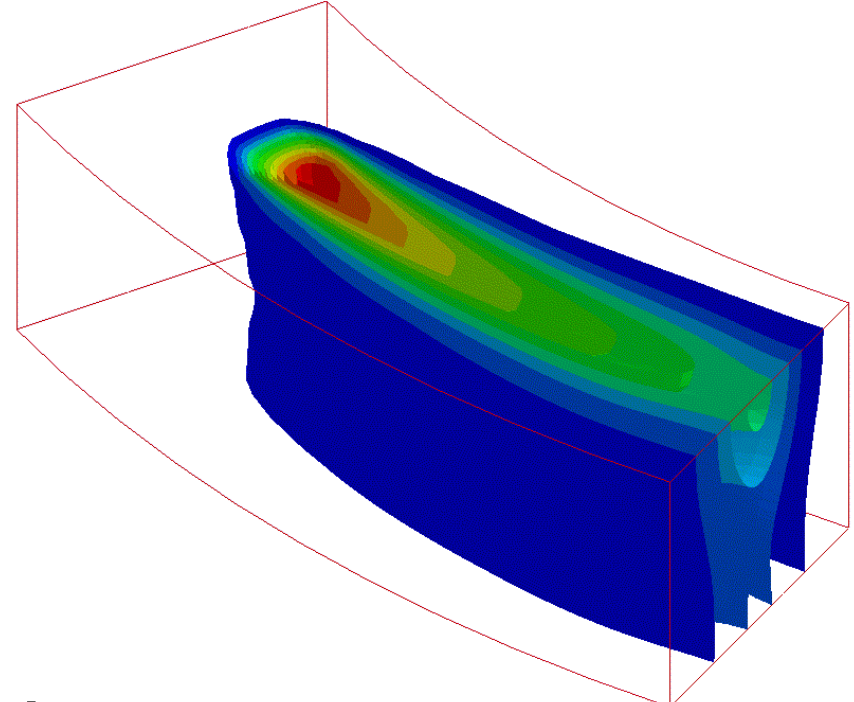
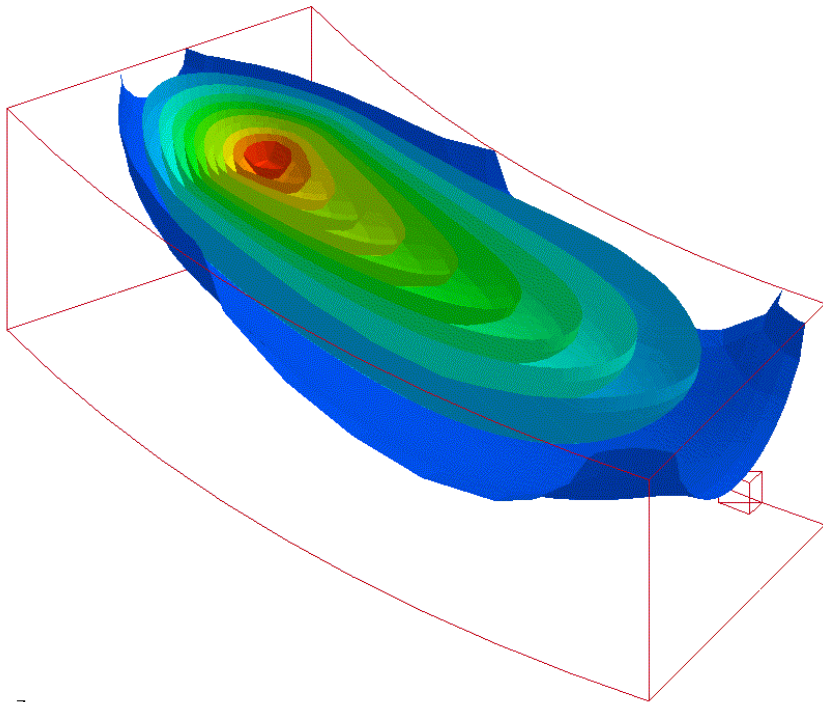

Heat source defined by flux boundary condition

- Laser assisted sheet forming:
 - the laser heats the material and softens it for forming
 - Energy from the laser is modeled using a flux boundary condition

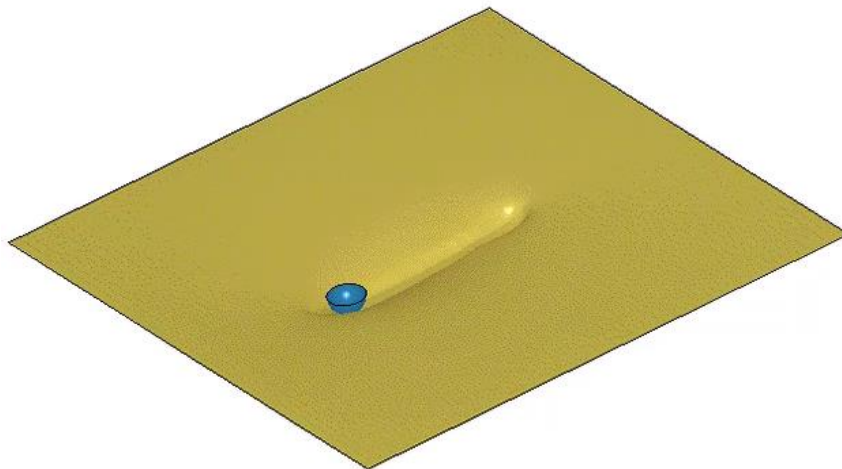
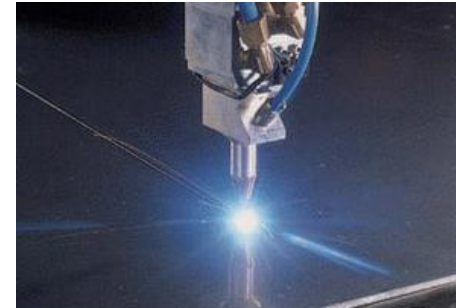

Deformation

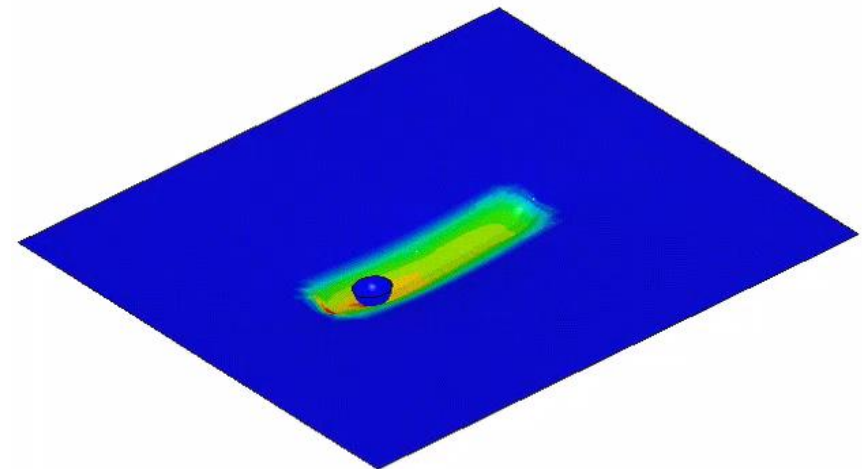

Temperature



Material Modeling

*MAT_CWM: Computational Welding Mechanics

- Both mechanical and thermal CWM model available
- Elements are initially "Ghost" or "Silent" until activated at a specific temperature
 - typically very low stiffness, zero Poisson's ratio
 - negligible thermal expansion
 - low thermal conductivity
- After activation, material with temperature dependent
 - mechanical properties
 - Von-Mises plasticity with mixed isotropic/kinematic hardening
 - thermal expansion
 - thermal properties

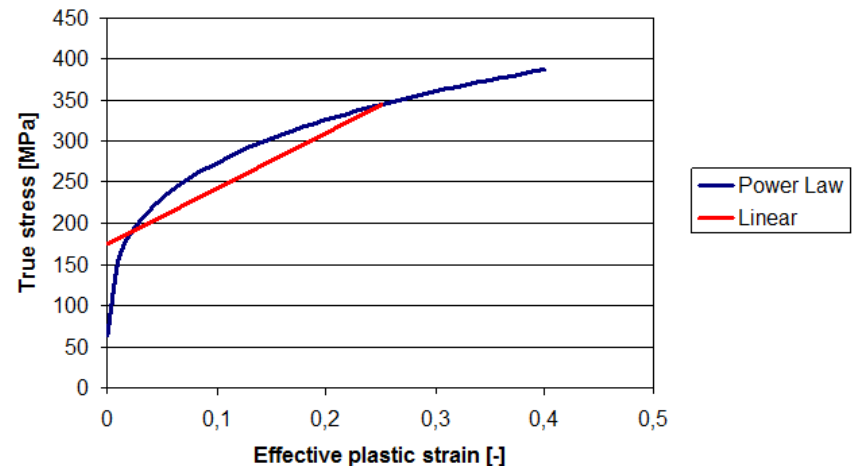

*MAT_CWM: Computational Welding Mechanics

- Annealing at specific temperature
- Available for shell and solid elements

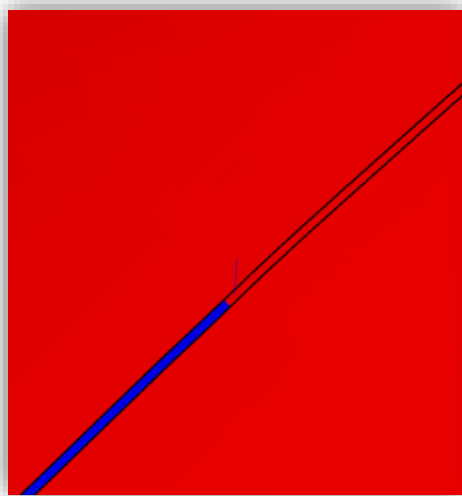

activation

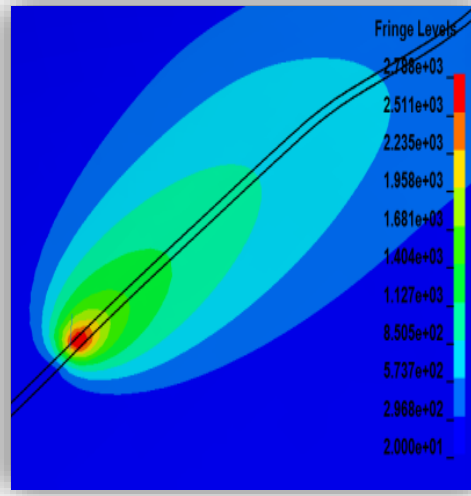

temperatures

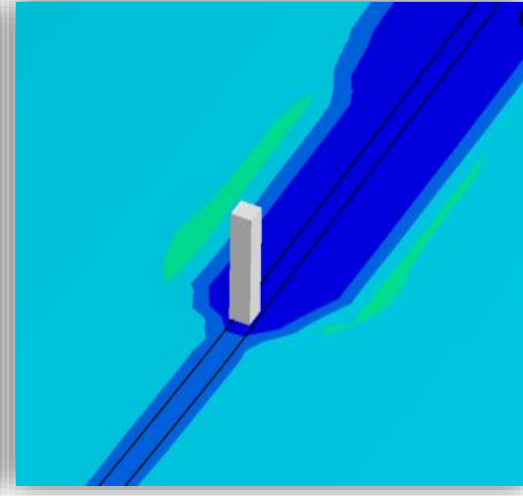

annealing

*MAT_UHS_STEEL/*MAT_244

- Material tailored for hot stamping / press hardening processes
 - Phase transition of austenite into ferrite, pearlite, bainite and martensite for cooling
 - Strain rate dependent thermo-elasto-plastic properties defined for individual phases
 - Transformation induced plasticity algorithm
 - Re-austenitization during heating
 - User input for microstructure computations is chemical composition alone
- Added:
 - Transformation induced strains
 - Welding functionality (“ghost” state)
 - Different transformation start temperatures for heating and for cooling

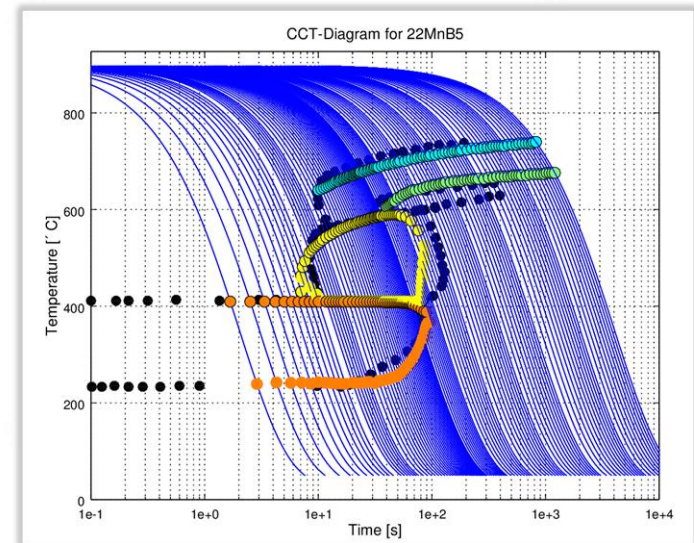

*MAT_UHS_STEEL / *MAT_244

- Temperature dependent definition for thermal expansion for austenite and the hard phases
- Dilatometer experiments show transformation induced strains as temperature dependent jumps

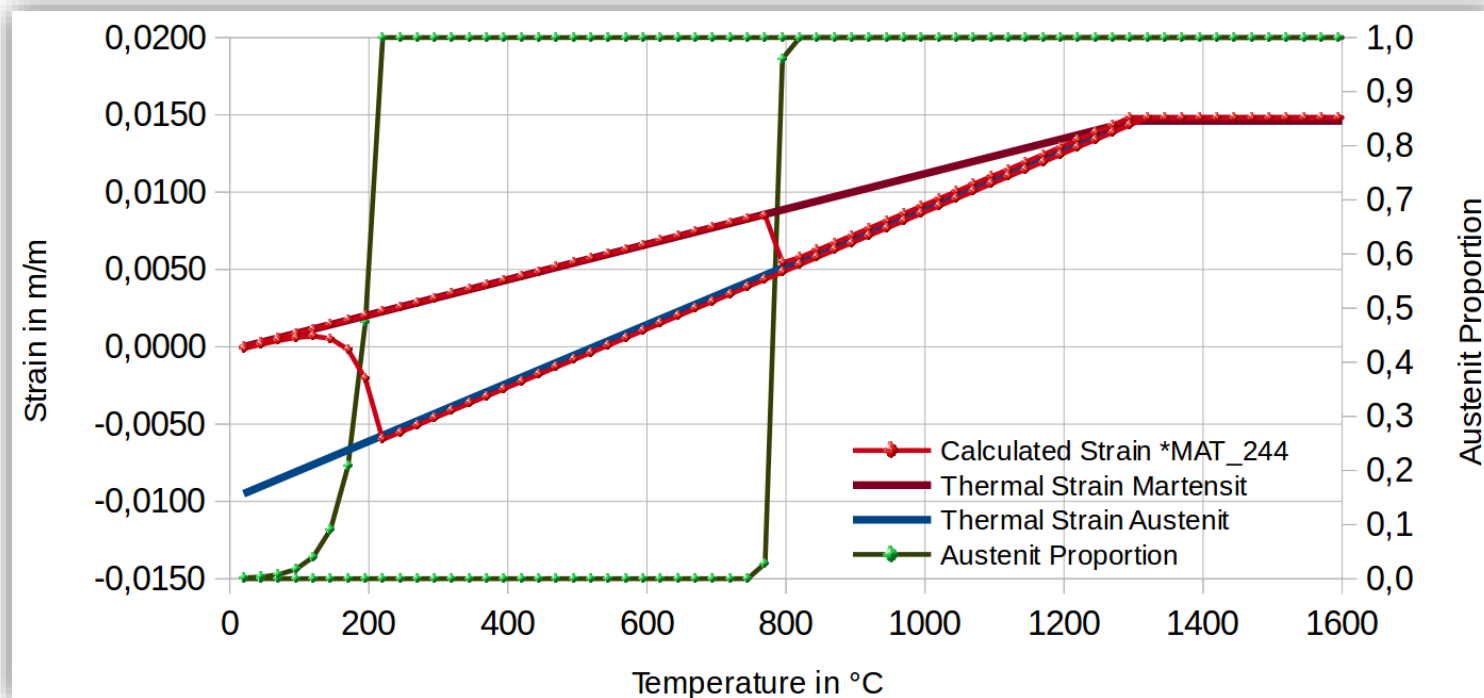

*MAT_UHS_STEEL / *MAT_244

Gefügeumwandlungstest 1.0 - 10.0

Time = 16.8

Contours of Temperature

min=293, at node# 5

max=1555.24, at node# 49

max displacement factor=50

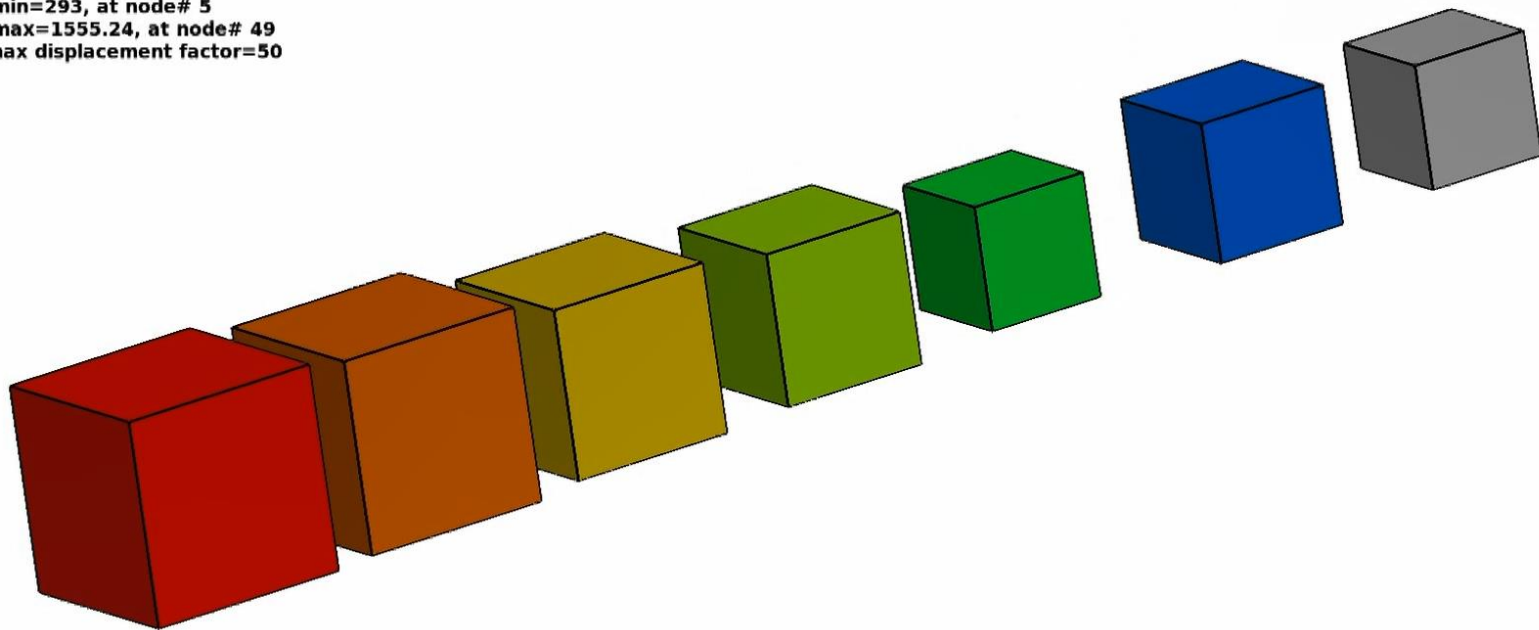

Fringe Levels

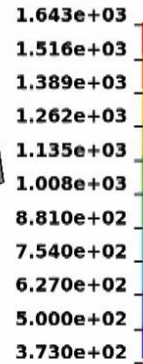

www.loose.at

*MAT_UHS_STEEL / *MAT_244

Example: Round Robin

- Geometry: notched block with 2 weld seams
- All materials are initialized in ferrite phase

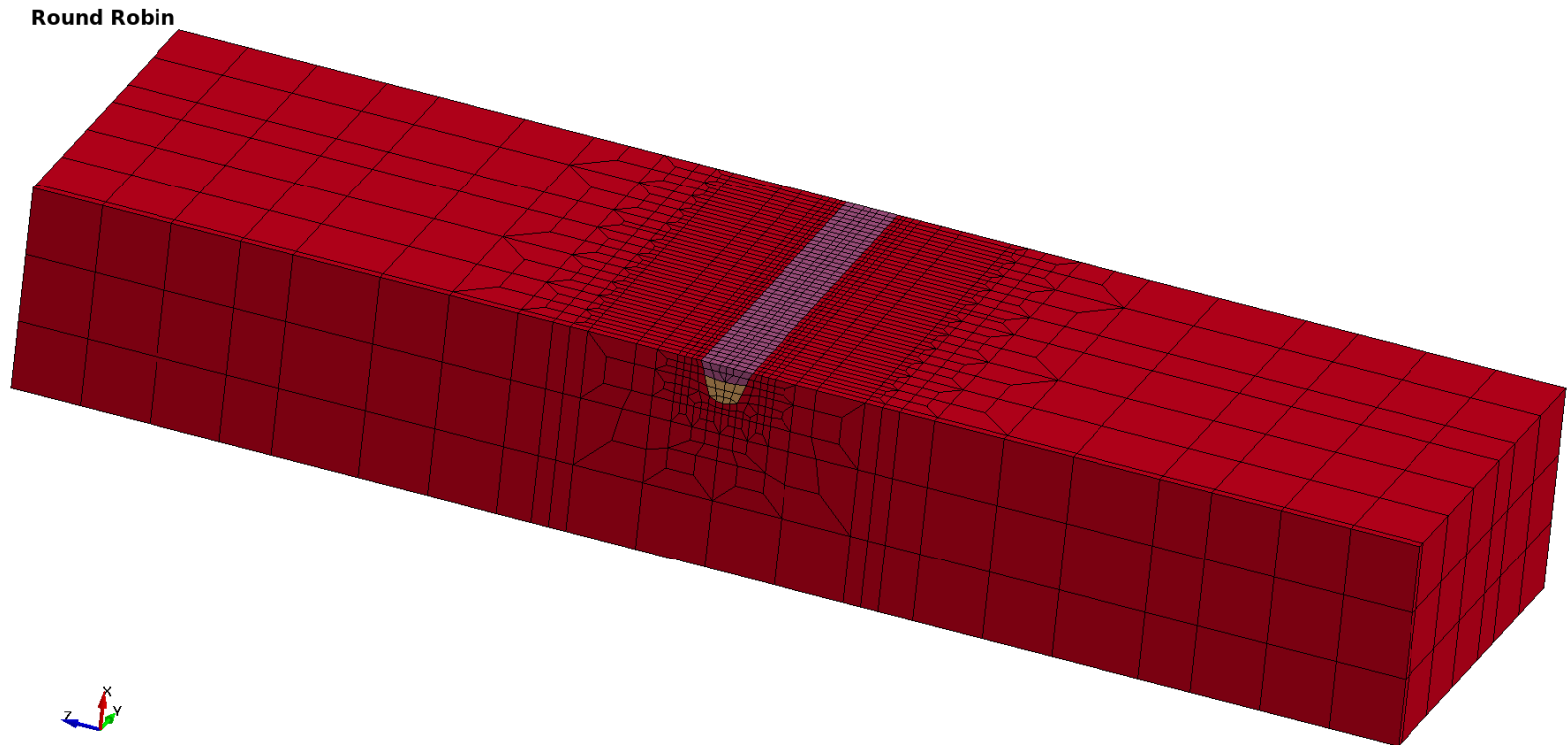

*MAT_UHS_STEEL / *MAT_244

■ Temperature

Time = 24.267

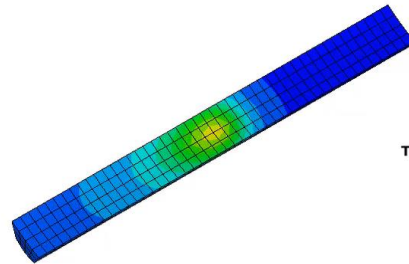
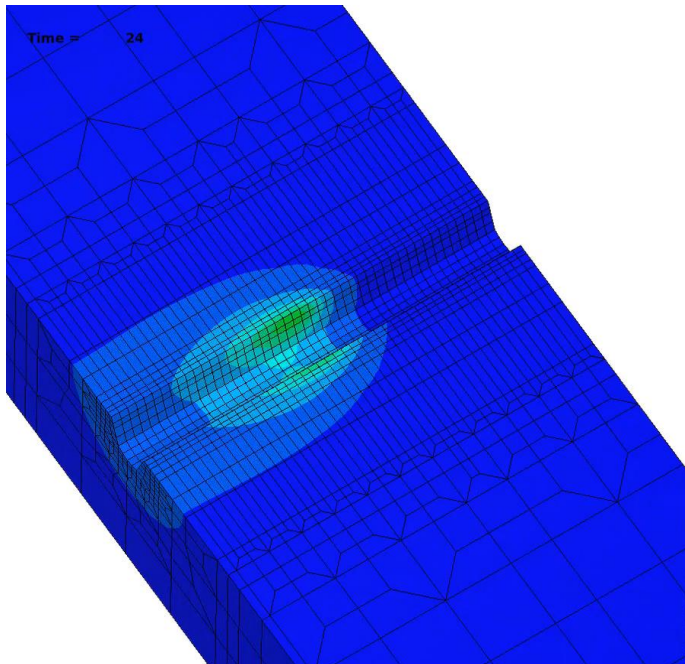

Time = 24.267

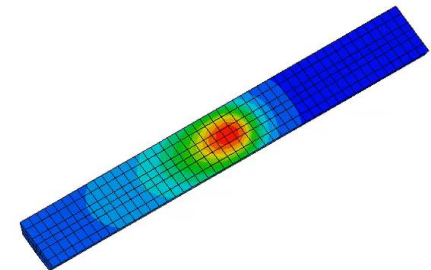

*MAT_UHS_STEEL / *MAT_244

■ Austenite concentration

Time = 28.533

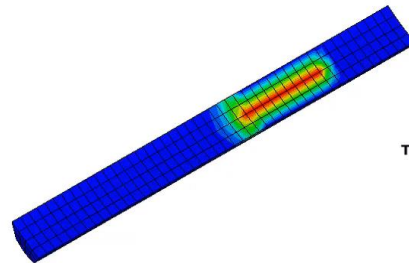
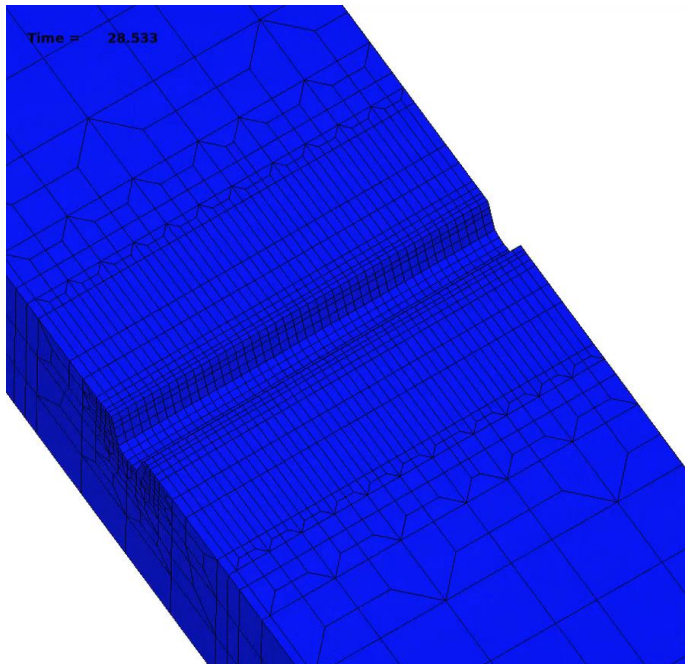

Time = 28.533

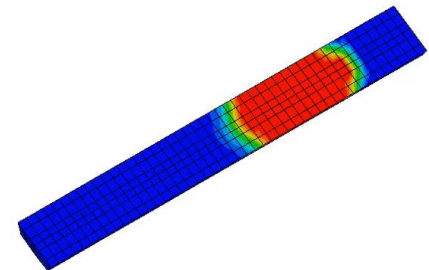

*MAT_UHS_STEEL / *MAT_244

■ Martensite concentration

Time = 29.867

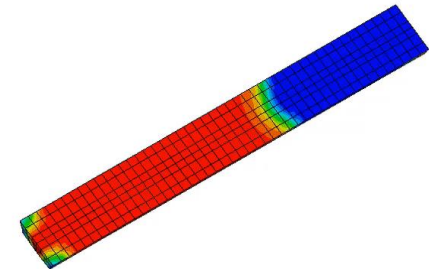
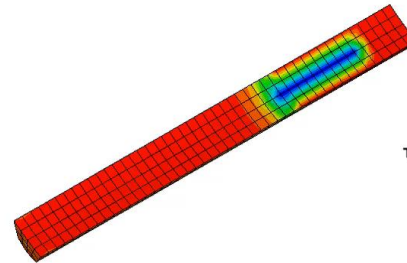
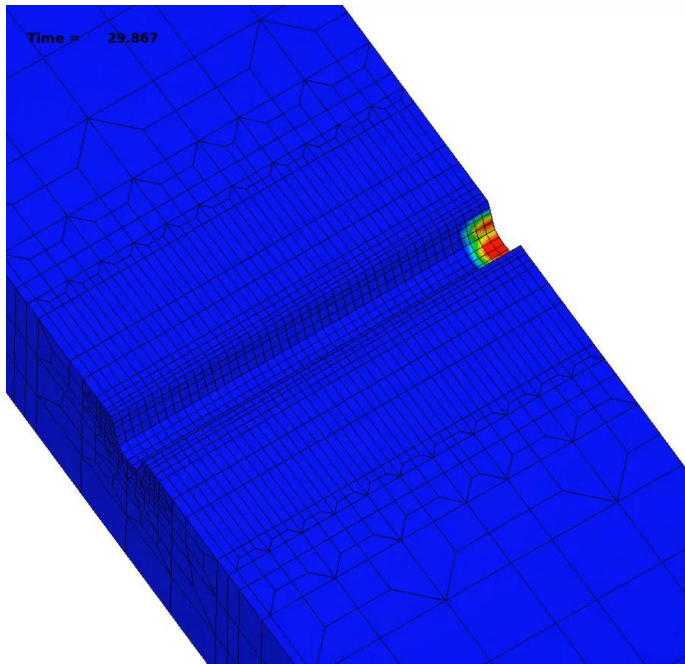

Example with *MAT_UHS_STEEL

- A gear is heated, quenched, welded to a joint

Welding Gear # www.loose.at
Time = 0
Contours of Temperature, middle
min=293.15, at node# 99000011
max=293.15, at node# 99000011

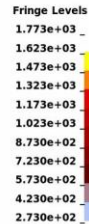
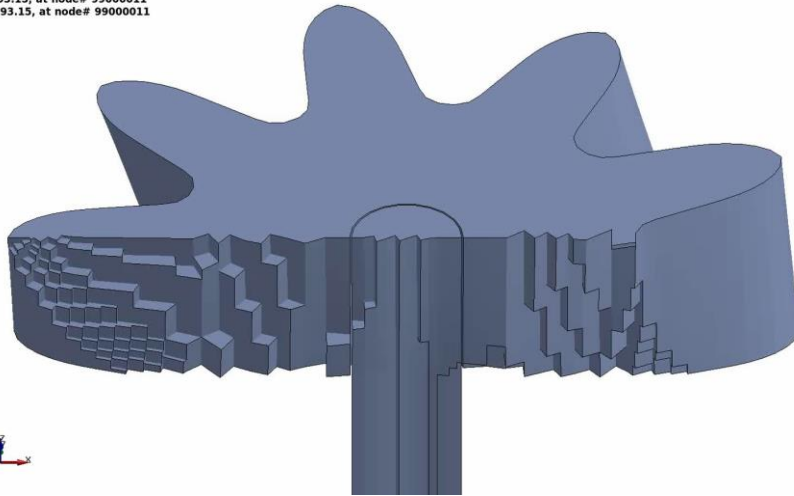

Welding Gear # www.loose.at
Time = 0
Contours of History Variable#5
min=0, at elem# 99000011
max=0.997499, at elem# 35010

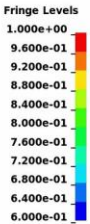
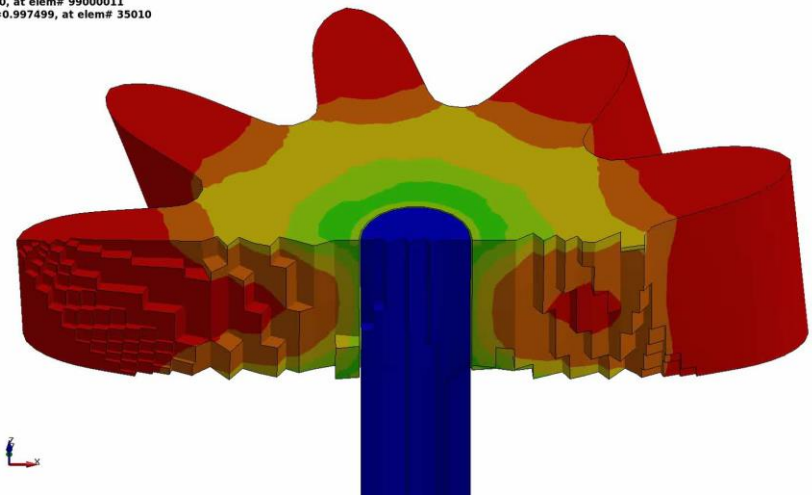

Martensite concentration

Temperature field

***MAT_244 is only valid for a narrow range of steel alloys!**

Heuristic formulas connecting chemistry with mechanics fail otherwise!



www.loose.at



Latest Developments

*MAT_254

- Implementation of ***MAT_GENERALIZED_PHASE_CHANGE**

- Features
 - Up to 24 individual phases
 - User can choose from generic phase change mechanisms (Leblond, JMAK, Koistinen-Marburger,...) for each possible phase change
 - Material will incorporate all features of *MAT_244
 - Phase change parameters are given in tables and are not computed by chemical composition

- Will be suitable for a wider range of steel alloys and aluminum alloys

- Parameter of the material might come from a material database or a microstructure calculation

*MAT_254 with JMAK

■ First example: Phase change test for steel S420

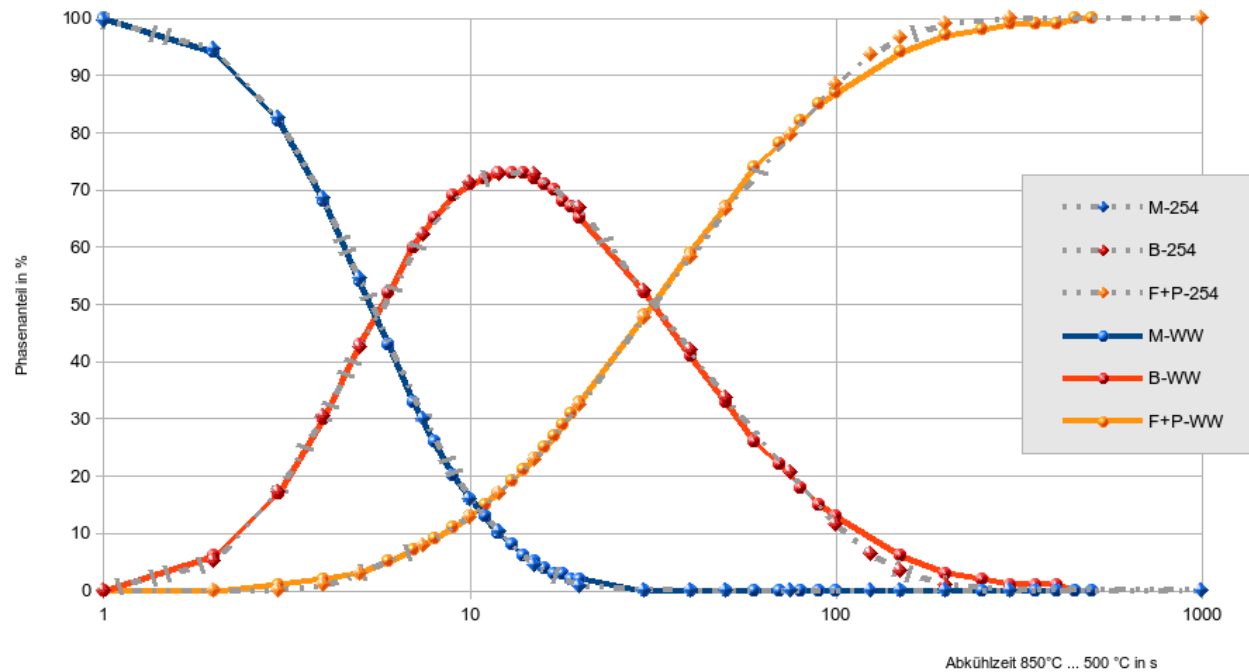

Welding without filler elements

- Ghost element approach is not suitable for all welding processes
 - No material might be added in the process
 - Significant sliding of parts before welding
- New contact formulation
 - *CONTACT_AUTOMATIC_SURFACE_TO_SURFACE_TIED_WELD_THERMAL
 - As regions of the surfaces are heated to the welding temperature and come into contact, the nodes are tied
 - Regions in which the temperature in the contact surface is always below the welding temperature, standard sliding contact is assumed
 - Heat transfer in the welded contact zones differs as compared to unwelded regions
 - Right now, only implemented for contact between solid elements

*CONTACT__AUTOMATIC_SURFACE_TO_SURFACE__TIED_WELD_THERMAL

■ Example: butt weld

- During welding the blocks are allowed to move
- Assumption: Insulation in unwelded state, perfect heat transfer after welding

welding_contact_automatic_tied_weld_thermal.k
Contours of Temperature
min=20, at node# 9001
max=951.096, at node# 7032

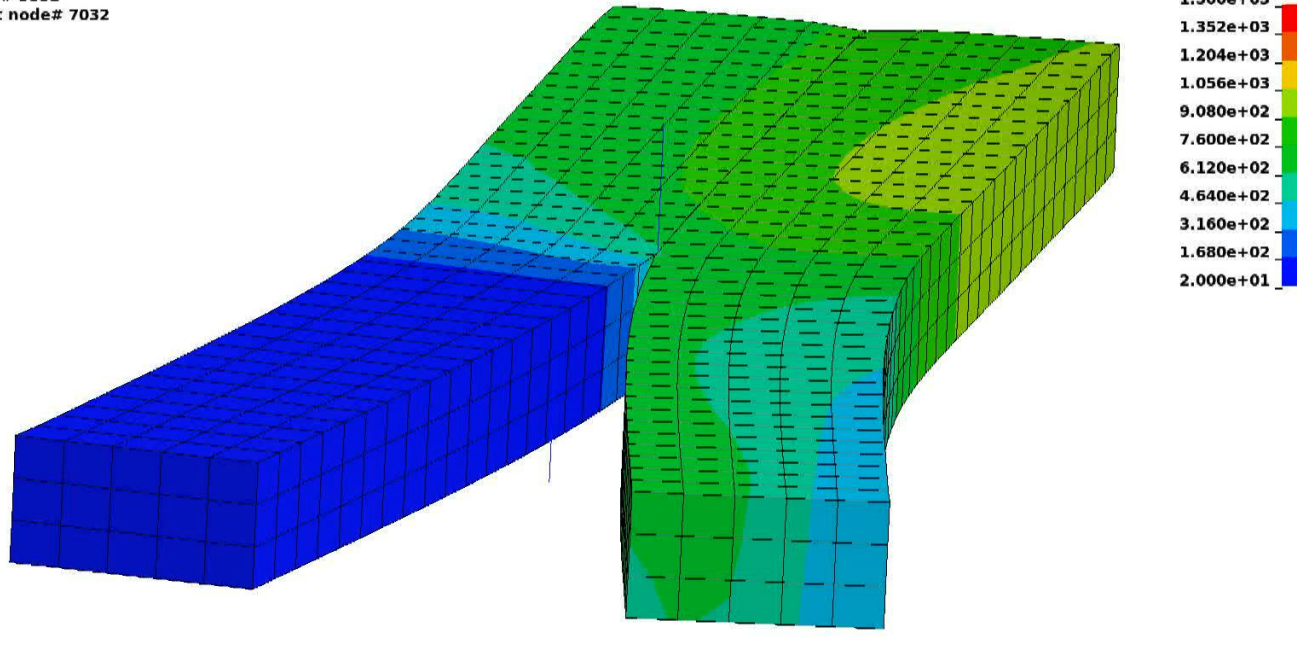

Hybrid welding simulation

- Analytic-numerical hybrid approach for calculating welding distortions developed at the BTU Cottbus

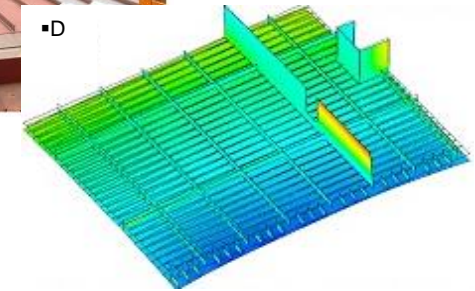
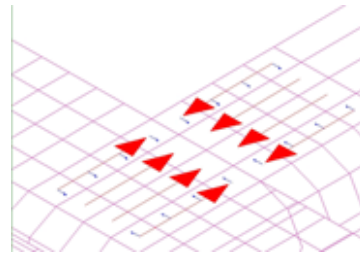
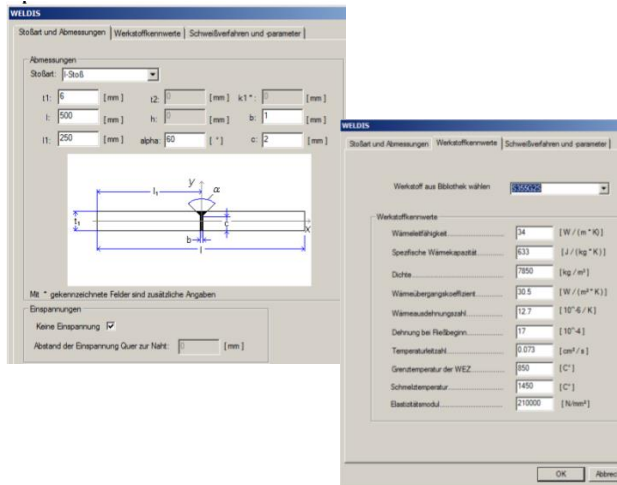

▪ Courtesy of BTU Cottbus

- Analytical model calculates longitudinal and transversal strains and their distribution for every single weld.
- Mechanical loads are applied on an elastic FE-model of the structure.
- ➔ Prediction of distortions for large structures with long weld seams
- ➔ well suited for optimization of welding process

Summary

LS-DYNA offers many special features for welding simulations:

- Realistic modeling of welding heat source
 - Goldak and other heat source geometries
 - Flexibility for arbitrarily shaped heat sources
- Material modeling for welding:
 - Ghosting approach that allows to deal with filler materials in weld seams
 - MAT_CWM: Computational Welding Mechanics
 - Comprehensive material formulations including microstructure phase changes
 - MAT_244 for certain UHS steel alloys
 - MAT_254 under development for a large variety of different metals
- Special welding contact

➔ **LS-DYNA is a general purpose (Finite Element) solver that can be used to simulate the complete manufacturing process chain.**



Thank you for your attention!



Your LS-DYNA distributor and more