

# Simulation of Spot Welds and Weld Seams of Press-Hardened Steel (PHS) Assemblies

Author: Stanislaw Klimek

Adam Opel GmbH, Rüsselsheim, Germany

## Summary:

Today's automotive industry is challenged with reducing fuel consumption, CO<sub>2</sub> emissions, weight and cost. The usage of ultra high strength steel is one possibility to reduce weight and improve crash behaviour. The development with press-hardened steel (PHS) is challenging as the material behaviour is more difficult to predict not only in tests but especially in full vehicle simulations.

The predictability of failure of PHS in simulation is a very complex task. Not only does the PHS material itself need new modelling and simulation techniques to develop robust crash behaviour, but also the influence of spot welds and weld seams requires different modelling parameters.

The development of a simulation method, together with the validation for the PHS part, will be shown to demonstrate correlation and predictability of development by the use of CAE.

## Keywords:

Predictive simulation of Press-Hardened Steel, Spot weld simulation, p Weld seam simulation

## 1 Introduction

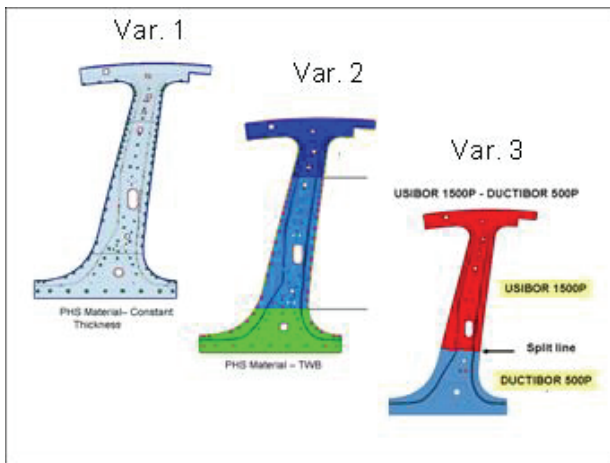
With growing globalisation, quantity and severity of automotive crash safety requirements are increasing dramatically. Side crash tests performed in different countries may have different barrier design, stiffness, weight and velocity. In every case, the structural performance is based on measurements indicating the amount of intrusion into the occupant compartment in the area of the B-pillar. The most severe load parameters, with regard to the B-Pillar intrusion, are detailed in the IIHS side impact (The Insurance Institute for Highway Safety) [2]: *“Lower centre-pillar velocity and y-displacement help reached good IIHS rating of injury measures, especially from the head/neck and torso (chest and abdomen), are major components of each vehicle's overall evaluation. Less intrusion helps assure that other occupants of sizes and in seating positions different from the dummies also would have lower injury risk.”*

A 125 mm minimum residual space (distance between middle of driver seat before test and the nearest point on the B-Pillar (metal sheet) after test [2]) is required for good structure rating.

Using ultra high strength steel (UHSS) to reduce weight while also improving crash behaviour is a new challenge for CAE. UHS steel helps to reduce intrusion in side crash, but also shows lower ductility compared to traditional steels, which adversely affects the control of part integrity so that the design of the respective parts needs special care.

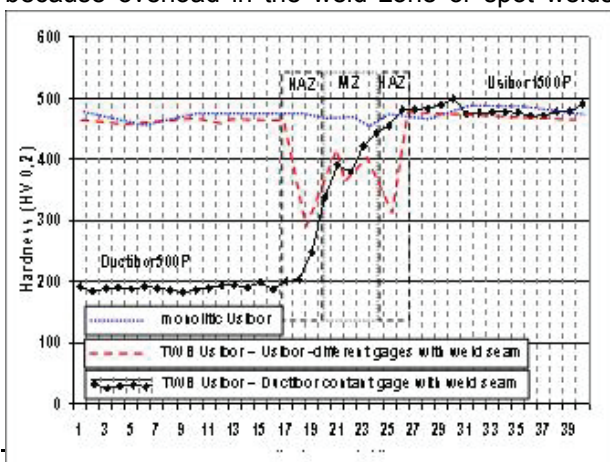
## 2 B-pillar design

In order to improve simulation capabilities regarding the application of UHSS, a generic B-pillar reinforcement was constructed. Three different B-pillar concepts (Fig. 1) were chosen for investigation. The monolithic version was used as the reference solution for the two Tailor Welded Blank (TWB) alternative solutions, the first one with the same material and different gages and the second TWB B-pillar reinforcement with the same thickness but with different materials, the upper part of B-pillar being UHS steel and the lower part Ductibor 500P.



**Figure 1. B-pillar reinforcements examined: monolithic UHSS, TWB UHSS / UHSS with variable thickness and TWB UHSS / Ductibor 500P with constant thickness.**

The TWB solution reduces the weight and allows better balancing of stiffness without additional parts. However, in this solution, the robustness of the weld zone must be thoroughly investigated, because overload in the weld zone or spot welds might induce a crack. Laser welding of Usibor 1500P / Ductibor 500P Laser Welded Blank (LWB) and of Usibor 1500P / Usibor 1500P LWB requires considerable care, because some AlSi coating dilution occurs in the molten zone, resulting in the production of Fe-Al-Si.



1500P / Ductibor 500P Laser Welded Blank (LWB) and of Usibor 1500P / Usibor 1500P LWB requires considerable care, because some AlSi coating dilution occurs in the molten zone, resulting in the production of Fe-Al-Si.

**Figure 2. Hardness measurements for monolithic UHSS and for the molten zone Usibor 1500P/ Usibor 1500P compared to molten zone Usibor 1500P / Ductibor 500P**

Ductibor 500P is characterized by excellent stability during the hot-stamping process and by high ductility after hot-forming (the UTS is around 600MPa and elongation can exceed 20%). The final microstructure is a combination of ferrite and martensite, with stable ferrite grain size even with large cooling speed variations, ensuring the necessary robustness with regard to the processing conditions.

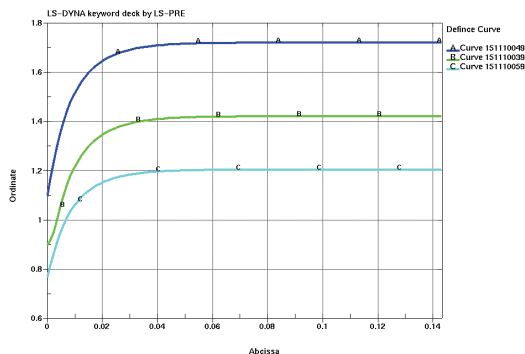
Due to the lower carbon content of Ductibor 500P, compared to Usibor 1500P / Usibor 1500P LWB, dilution occurs in the molten zone during welding, which ensures a smooth transition zone between the two blanks, as shown on the figure below. The molten zone is then less sensitive to varying hot-stamping conditions (Fig. 2).

### 3 CAE approach

UHS steel exhibits a very high necking strain [4] compared to the gauge length strain, which is not higher than 6 – 8 % plastic strain. Hence, simulation, using this lower value as a failure criterion will be very conservative. The investigation in [4] shows the best correlation between test and simulation is achieved by using MAT\_123 (1) and the major in-plane strain at failure (31% as limit for local strain) as a damage criteria for UHS steel (which in that case was BTR165). However, this is not the only way for more accurate prediction of failure in UHS steel and currently this topic is being very intensively investigated by many institutes and OEMs around the world.

For the development of the B-pillar the material definition in (4) is used: MAT\_123 (\*MAT MODIFIED PIECEWISE LINEAR PLASTICITY)

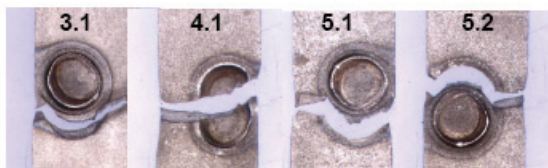
All B-Pillar parts are refined with an element size between 3 and 5 mm. The UHSS B-Pillar reinforcement is split into many parts with similar properties in separate areas main part, weld seam area (only by using tailor welded blank), spot weld area, outline area and boundary areas of larger holes.



All these areas differ in material properties due to changes caused by cooling, or use of tailor welded blanks, or of different tool-cutting techniques (Fig.3) or also the quantity and quality of spot welds. The tailor welded blank area is defined with reduced material quality.

**Figure 3. Example of UHS steel strain – stress curves: curves A & B are inside specificity tolerances and curve C outside the tolerances affected by the welding or cooling process.**

Of special interest is the investigation of the failure behaviour in and around the spot weld areas. Spot welding leads to diminution of the material in the proximity of the spot.



Usually, the steel sheet starts to crack in the heat affected zone (Fig.4) encircling the spot weld (3).

**Figure 4. Failure in high speed tensile tests: UHSS specimen with spot weld (3)**

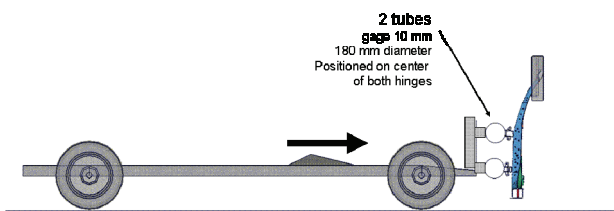
Therefore, solid elements in the B-pillar components without failure are used for spot weld simulation (MAT #100, (1)). Thus the potential failure location is transferred from spot welds into the proximity of the spot welds. For this reason, it is necessary to separate the PID for spot welds, in all parts in

which the material properties are changed by welding or significant plastic deformation are observed in the heat affected zone. In this way, the spot weld modelling allows the predictive simulation of crack initiation and expansion in the main part.

If the failure of spot welds is allowed in the simulation, the material around the failed spot weld will be deleted, which can lead to unrealistic behaviour of the structure. In such a case, no crack would occur, but the failure of the spot weld would lead to erroneous conclusions.

#### 4 Component test configuration

The B-Pillar component test consisted of a mobile rigid barrier with 2 non-deformable tubes (each of gage 10 mm and diameter 180 mm) positioned at the centre of both door hinges.



The component test energy was chosen such, that it reflects the IIHS vehicle test (Fig. 6).

Figure 5. Component test – side view on mobile barrier and B-Pillar

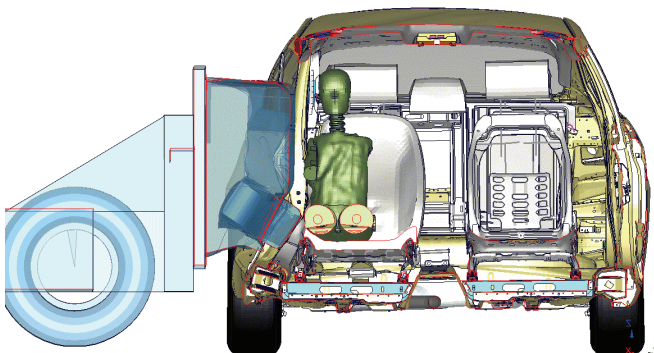
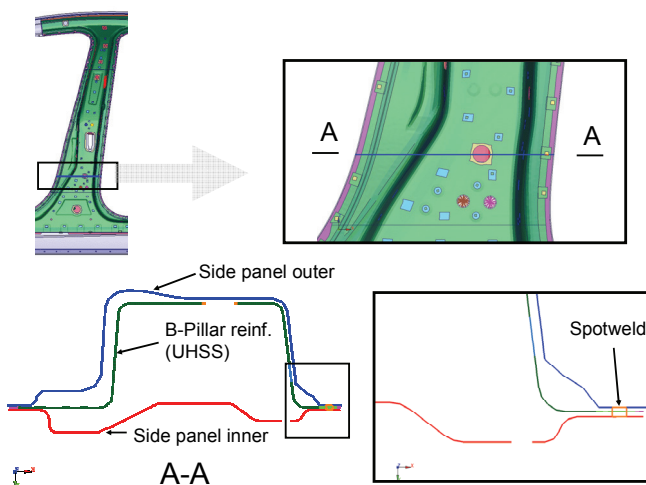


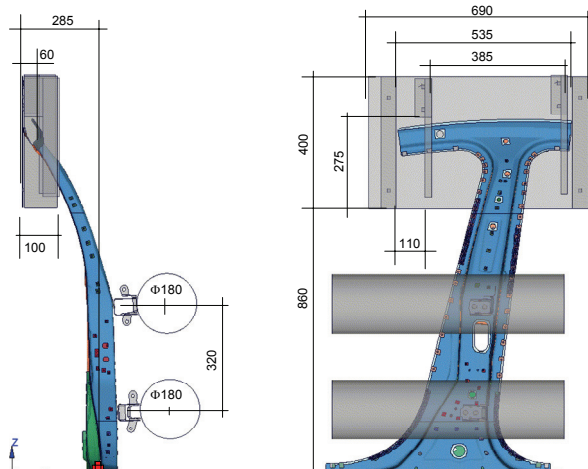
Figure 6. IIHS vehicle test



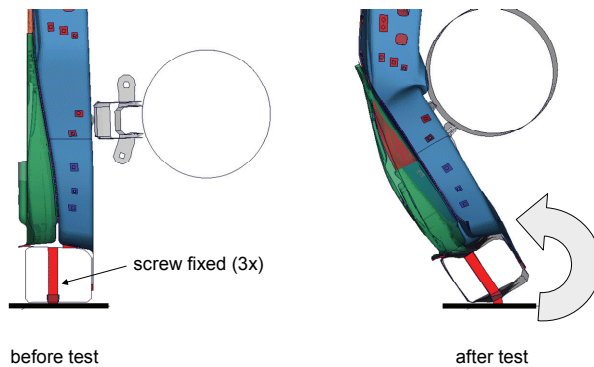
The component test was set up with the complete B-Pillar assembly (Fig.7) using spot welding and adhesive, including both hinges, as in a full vehicle, but without side panel.

Figure 7. Cross section of B-pillar assembly Part

The upper end of the B-pillar was free to move vertically (Fig.8), and the bottom of B-pillar component was welded to a quadratic tube which was bolted to the rigid plate. These screws are intended to simulate the torsional stiffness of the rocker.

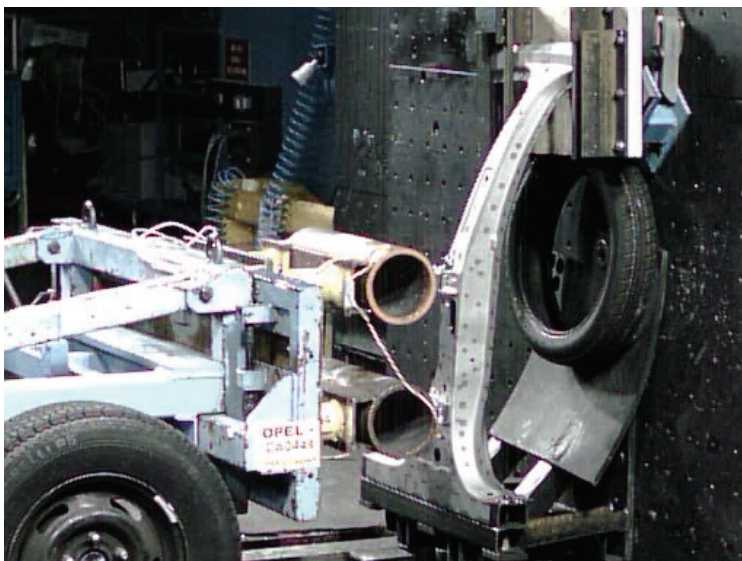


**Figure 8. Component test – measurements of B-pillar boundaries**



**Figure 9. B-pillar component test - lower fixation**

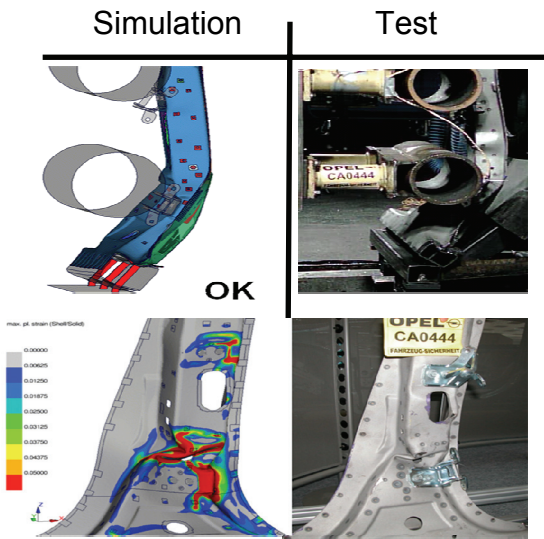
The acceleration of the barrier and the forces between barrier tubes and carriage were measured. For more detailed comparison with the test, three high-speed cameras were used.



**Figure 10. Real component test device**



5 Component test results



The B-pillar component test with monolithic design (Var. 1 from Fig. 1) deformed without any cracks in the structure or failure in the spot welds. The deformation behaviour during the test showed a very good correlation with simulation results (Fig. 11). This also applies for the respective forces (Fig. 12).

Figure 11. Deformation behaviour – comparison test / simulation for monolithic B-pillar design.

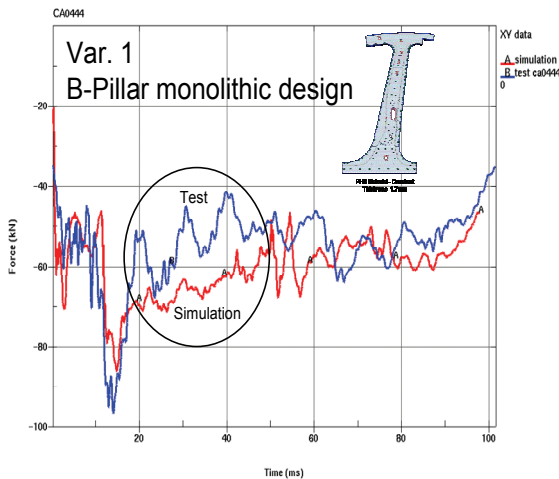
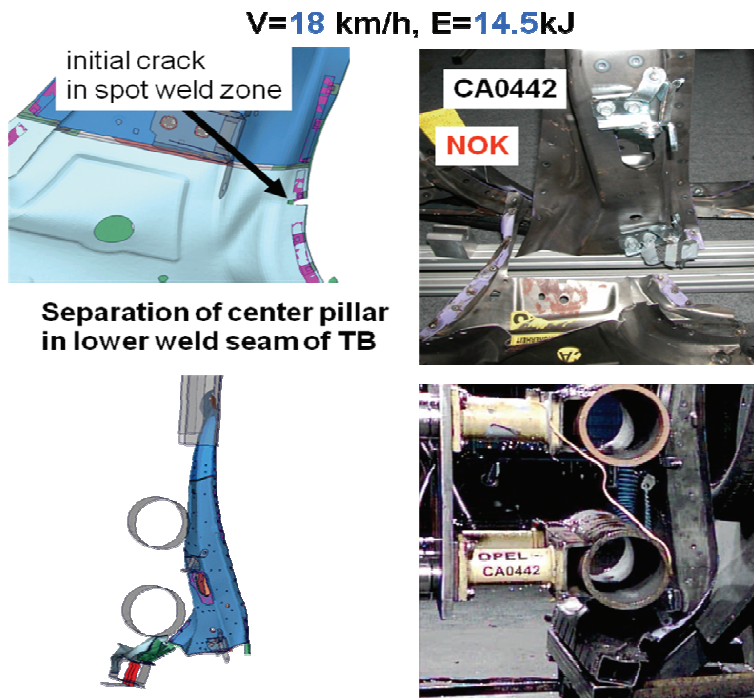


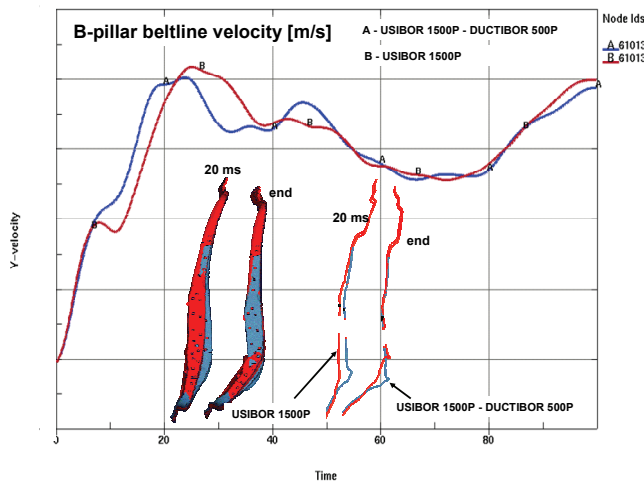
Figure 12. Total force – comparison test / simulation for monolithic B-pillar design.

The B-pillar component test with TWB design (Var. 2 from Fig. 1) with the same material but different gages separated completely in the lower weld seam area. The crack started at a spot weld (Fig. 13). This case also achieved very good correlation between test and simulation. Crack initiation position and further expansion together with timing correlated very well with the test. To use such a UHSS TWB solution, it is necessary to keep all spot welds away from the weld seam and to determine additional constructive measures to prevent the weld seam area cracking.



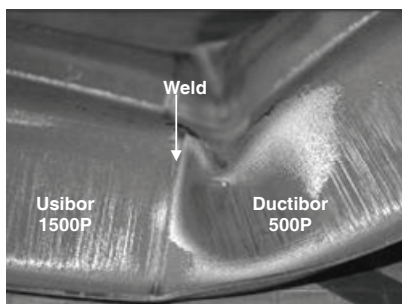
**Figure 13. Deformation behaviour – comparison test / simulation with TWB (UHSS with gauge variation) B-pillar design.**

The B-pillar component test of the TWB reinforcement design with constant thickness (Var. 3 from Fig. 1) but with different materials (upper part of B-Pillar is made of UHS steel and the lower part of Ductibor) is currently in the hardware preparation phase. The simulation of this design shows very promising results (Fig. 14). The maximum velocity on the B-Pillar beltline is a little lower than for the monolithic design but the end intrusions are similar (residual space in both cases are similar and much higher than the required 125 mm).



**Figure 14. B-pillar behaviour comparison (simulation only) between UHSS monolithic and TWB UHSS/DUCTIBOR design Vehicle IIHS test**

Arcelor performed high speed tensile tests and weld-centered 3-point bending tests to assess the weld quality, in order to evaluate the performances of Usibor 1500P / Ductibor 500P LWB concepts, see Fig. 15. These dynamic tests showed that the failure always occurred on the Ductibor 500P base



metal side, several millimeters from the weld line, just adjacent to the mechanical-properties-transition zone. The performances of the part could be tuned by gage optimization and weld positioning.

**Figure 15. Three point bending specimen (ArcelorMittal)**

## 6 Conclusions

To predict failure of PHS the model should have:

- fine element size for UHSS parts and the centre pillar assembly
- parts with different properties split into separate areas
- accurate material properties for UHSS with part splitting into separate areas (particularly important with prototype parts) as required for different properties
- failure criteria in metal sheets but no failure in the spot weld, to ensure any failure which occurs does so in the surrounding metal sheet, not the spot weld.

## REFERENCES

1. LS-DYNA KEYWORD USER'S MANUAL (VERSION 971) - VOLUMES I AND II  
LIVERMORE SOFTWARE TECHNOLOGY CORPORATION (LSTC)
2. THE INSURANCE INSTITUTE FOR HIGHWAY SAFETY - SIDE IMPACT CRASH  
TESTING/RATINGS CRITERIA  
[HTTP://WWW.IIHS.ORG/](http://www.iihs.org/)
3. INFLUENCE OF SPOT WELDING ON THE FORMABILITY OF PRESS HARDENED  
STEELS (PHS) – BASE RESEARCH AND LESSONS LEARNED. ATHORS: WOLFGANG  
EBERLEIN, HEIKE KANTEREIT,  
MATERIAL ENGINEERING METALLURGE, APRIL 2006, BERLIN, GERMANY
4. MATERIAL FAILURE APPROACHES FOR ULTRA HIGH STRENGTH STEEL, 5<sup>TH</sup> LS-  
DYNA ANWENDEFORUM, ULM 2006 H.WANG, S. SIVASANY, M. SCHRÖDER -  
BENTELER AUTOMOTIVE, PADEBORN, GERMANY