

Detailed Windscreen Model for Pedestrian Head Impact

G. M. Thompson (Adam Opel GmbH)

A. Kilgur (Mira Ltd.)



Wir leben Autos.

Detailed Windscreen Model for Pedestrian Head Impact

G. M. Thompson (Adam Opel GmbH)
A. Kilgour (Mira Ltd.)

12 October 2010



Summary

- Pedestrian head impacts on windscreen are a potential source of pedestrian injury and form part of the EuroNCAP Pedestrian Star Rating.
- Thus, there is a strong wish to increase pedestrian CAE predictive capability for windscreen impacts and hence create pedestrian safety measures early in the vehicle development cycle, rather than relying on expensive and time-consuming hardware testing.
- Existing CAE technology, because of the complex material behaviour involved, including fracture, did not enable realistic simulation of windscreen impact.
- This paper describes the development of new CAE techniques and more realistic material models for windscreens, in order to enable virtual development of protection measures to reduce pedestrian head impact injuries.



Windscreen CAE Model Development

- Test at various strain rates 2 constituent parts of windscreen system:
 - PVB (Poly Vinyl Butyral) foil
 - adhesive
- Create preliminary CAE material models for each
- Test complete windscreens dynamically at different strain rates
- Correlate windscreen tests & develop preliminary LS-Dyna CAE models for complete windscreen
- Test pedestrian adult 4.5 kg head v. full vehicles
- Further develop LS-Dyna CAE material models using vehicle tests



Hardware Test Series – Vehicle 1 Components

- Windscreen Component Material Tests
 - Testing performed with representative manufacturing conditions:
 - Tensile tests to obtain properties for treated PVB (Poly Vinyl Butyral) foil layer
 - Tensile tests to obtain properties for adhesive (Dow BETASEAL 1849).
- Windscreen Quasi-Static Tests & Photo-Elastic Measurements
 - Quasi-static test performed on full Vehicle 1 windscreen.
 - Windscreen mounted on 4 hemispherical posts.
 - 5th hemisphere used to apply load to centre or edge. 3 tests per location.
 - Strain gauges & photo-elastic coating used to record strain on inner face of windscreen.
- Windscreen Drop Tests
 - Dynamic drop tests of windscreen.
 - Screen bonded to rigid test fixture.
 - Drop tower used to apply medium-rate loading.
 - Locations as for quasi-static tests



Hardware Test Series – Vehicles 1& 2

4. Vehicle 1 Windscreen Impact Tests

- Head impact tests v. windscreen in Vehicle 1 production vehicle, interior cleared to avoid 2ndary impact
- 2 impact locations, each tested 3 times

5. Vehicle 2 Windscreen Impact Tests

- Cross check with several impact tests v. windscreen in Vehicle 2 production vehicle.



Windscreen PVB (Poly Vinyl Butyral) Foil

Material Testing

- Uniaxial tensile tests performed on treated PVB at 0.33mm/s, 1.6mm/s , 8.33mm/s.
- Force vs strain curves obtained for all 3 tensile test speeds.

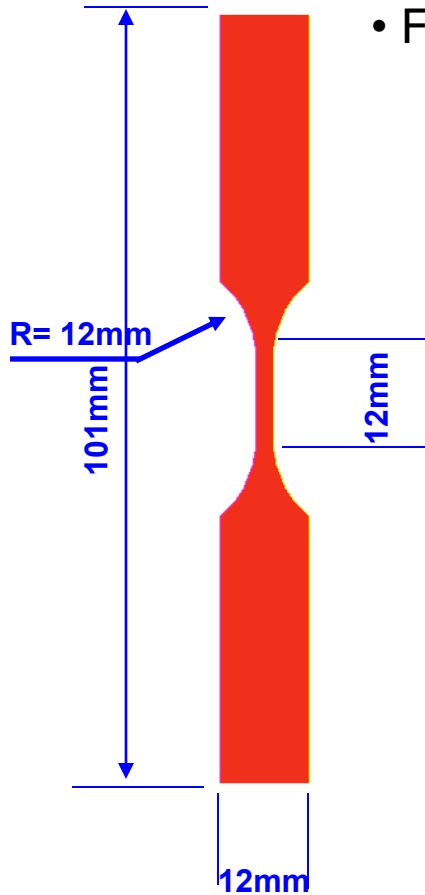

test specimen

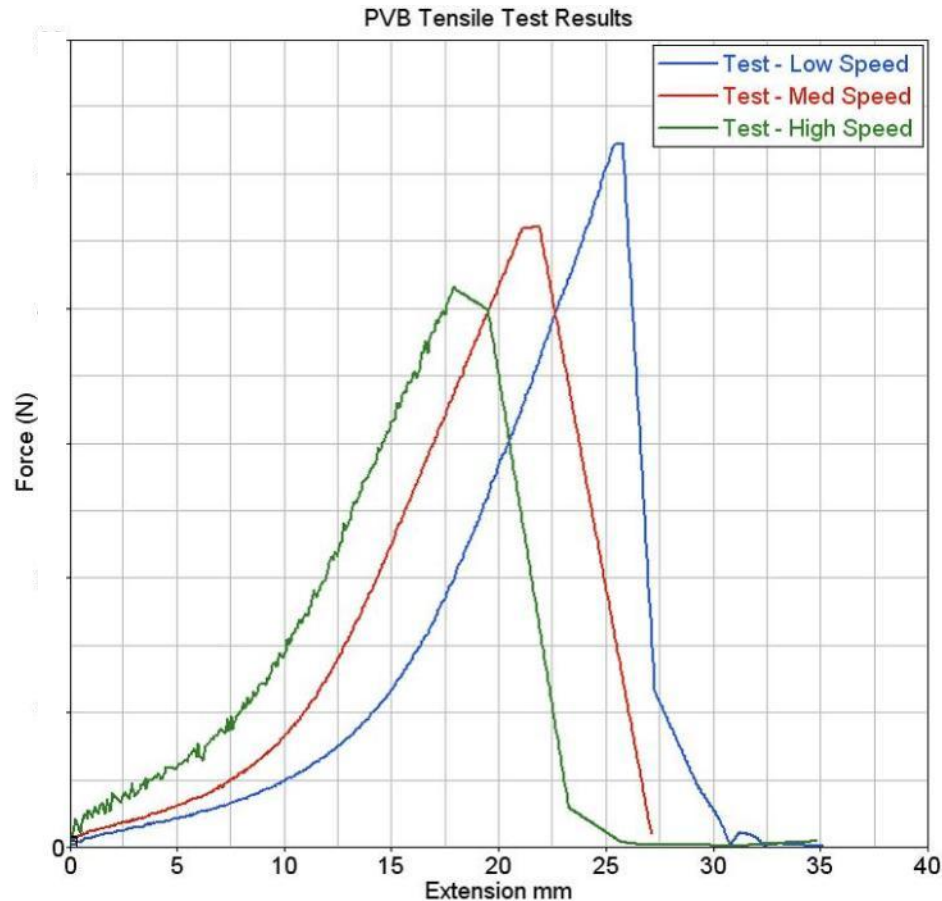

Windscreen PVB (Poly Vinyl Butyral) Foil CAE / Test

- Preliminary CAE models created to reproduce tests @ 3 speeds

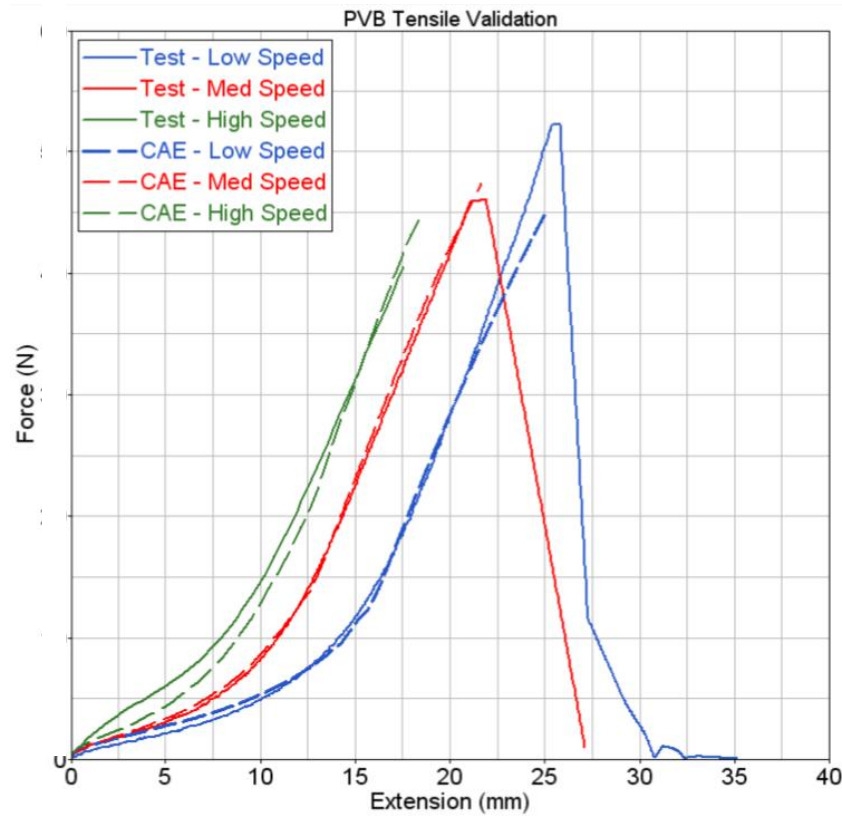

Windscreen Adhesive Testing & Validation

- Production line adhesive (Dow BETASEAL 1849) is cold-applied and takes 24+ hours to cure - not practical to reproduce in R & D project
- Windscreens were bonded into the car using RAC fast cure adhesive (RAC Driveaway – hot-applied, safe to drive within 1 hour of fitting)
- Cured material property data for adhesives supplied by manufacturers
- Samples supplied by manufacturers for testing
- Adhesive material model built & validated in head impact tests



Windscreen Adhesive Material Testing

- Uniaxial tensile tests performed on cured windscreen adhesive at low, medium and high speeds at 0.33mm/s, 1.6mm/s , 8.33mm/s.
- Force vs strain curves obtained for all 3 tensile test speeds.

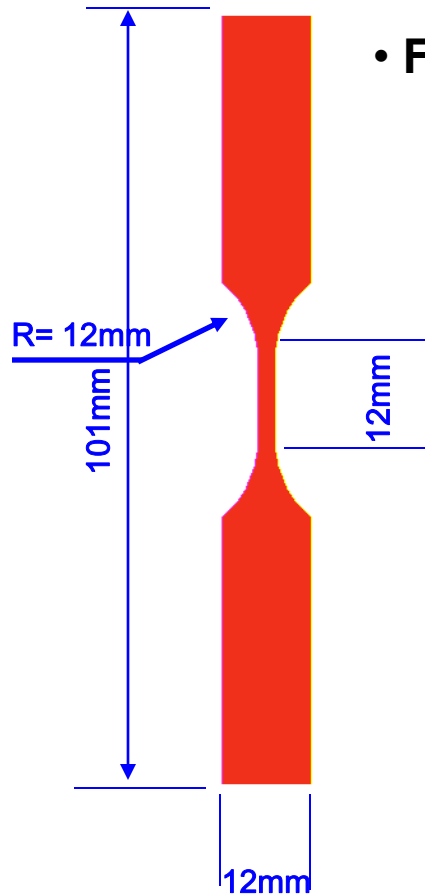

test specimen

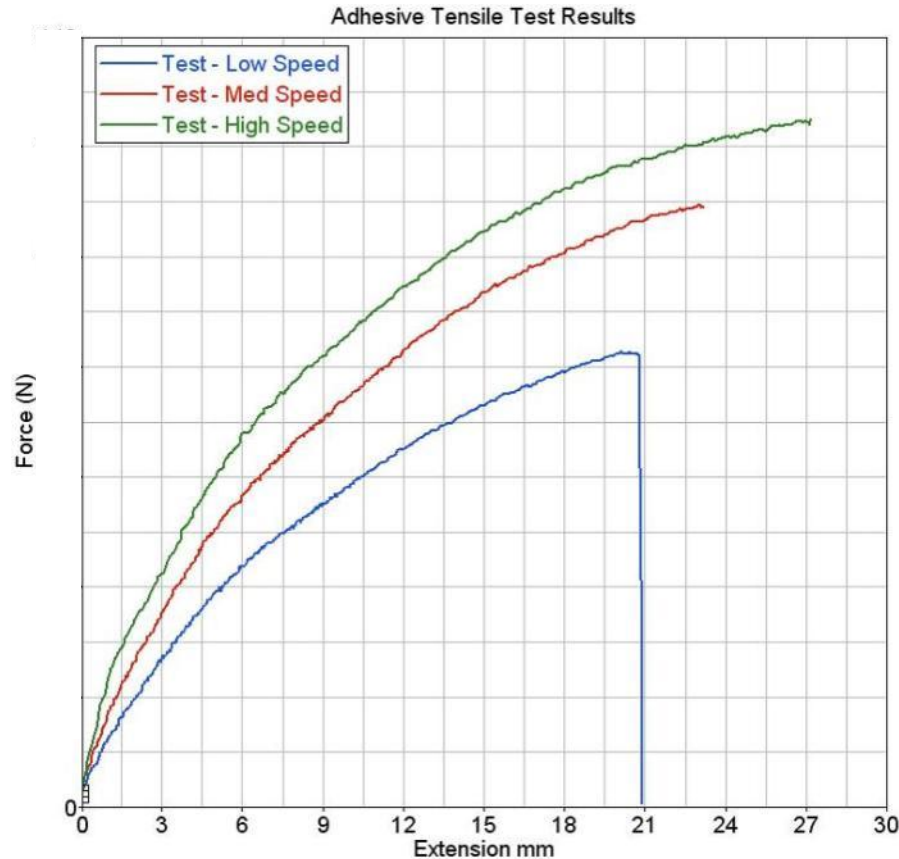

Windscreen Adhesive Material

CAE / Test

- Preliminary CAE models created to reproduce tests @ 3 speeds

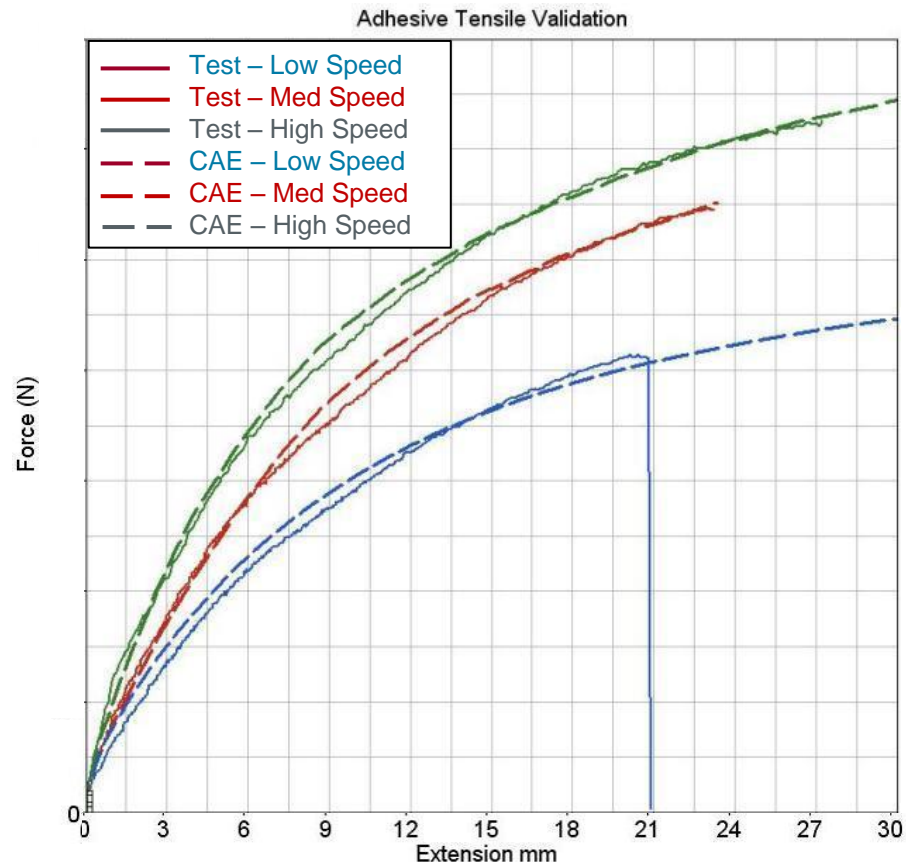

Quastistatic Windscreen Testing Set Up & Procedure

- 6 windscreens with applied load at centre and 6 at edge, all tested to failure.
- Inside surface of glass was covered by photo-elastic coating
⇒ Images of strain patterns taken at 1mm increments of deflection.
- Load & displacement data were recorded as the applied load was increased slowly.
- Strain on inside surface glass was recorded using a strain gauge.
⇒ strain gauges verified strain values from photo-elastic fringe images.

5th hemisphere applied load to centre.

windscreen mounted onto to 4 hemispherical posts

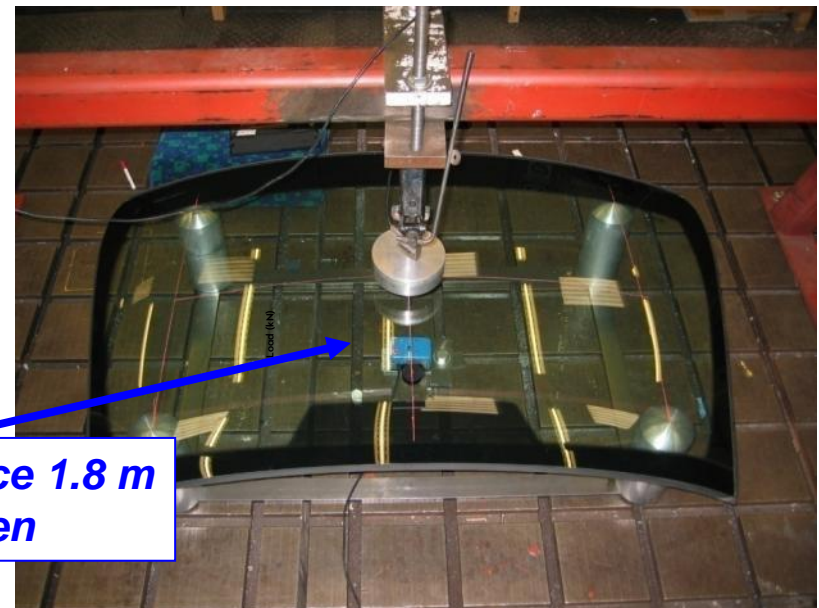
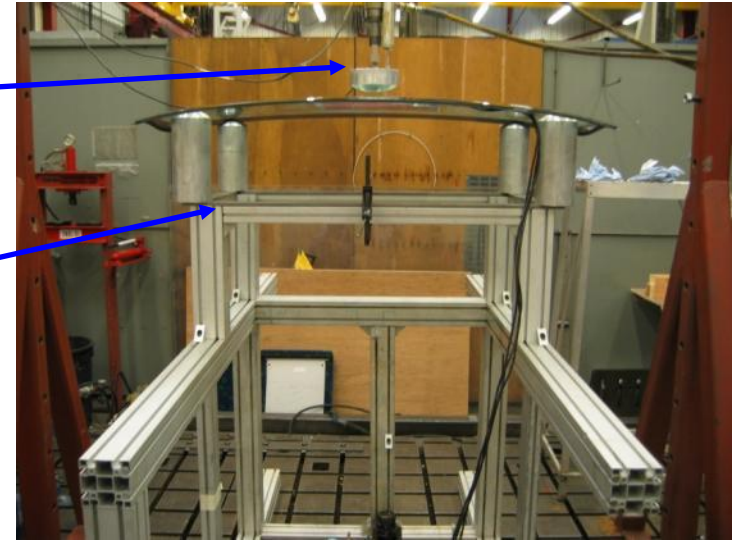

GFP1200 polariscope & light source 1.8 m directly under coated area of screen

Quasi-static Photo-Elastic Edge Stress Results

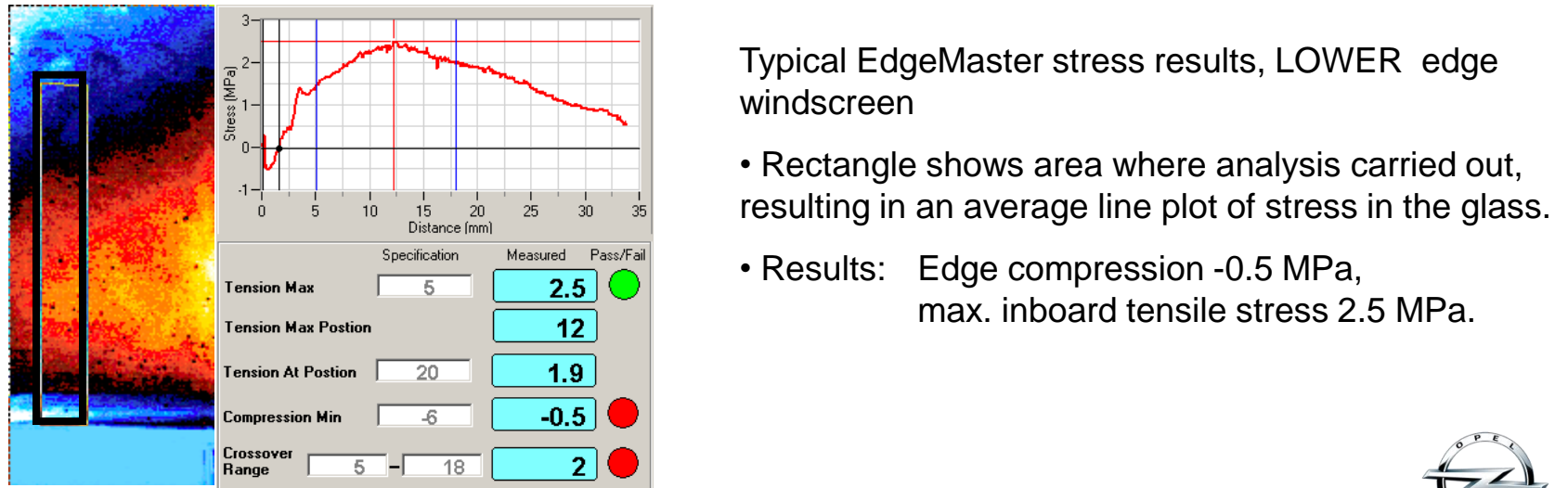
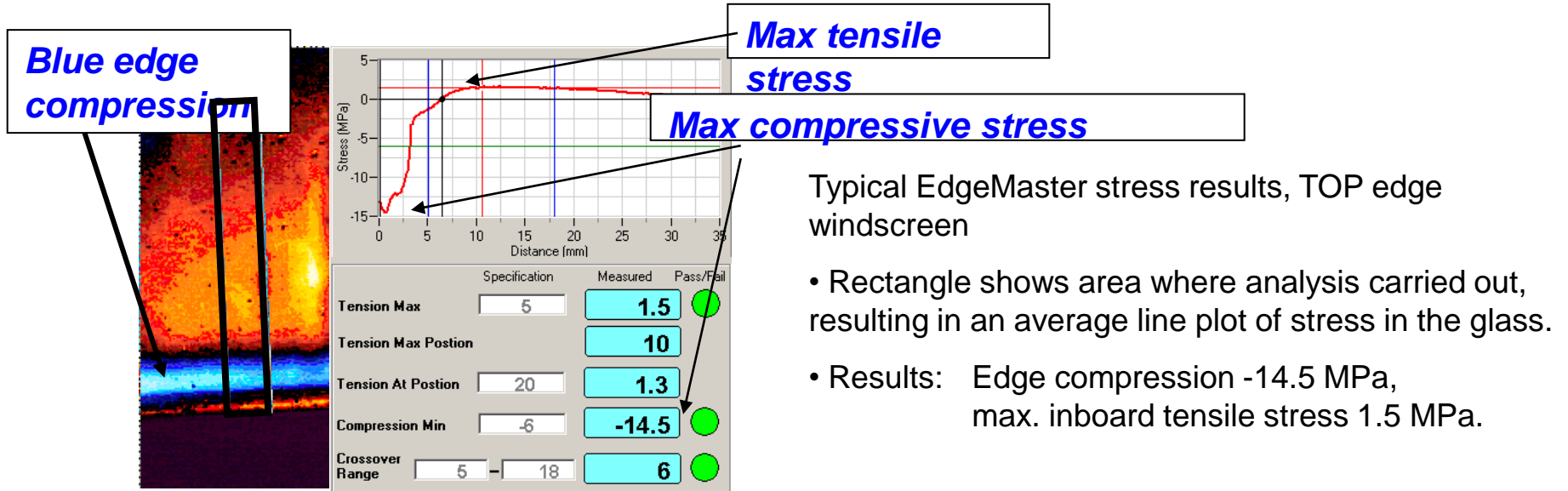

Quasi-static Photo-Elastic Deflection Results

Typical central loading results

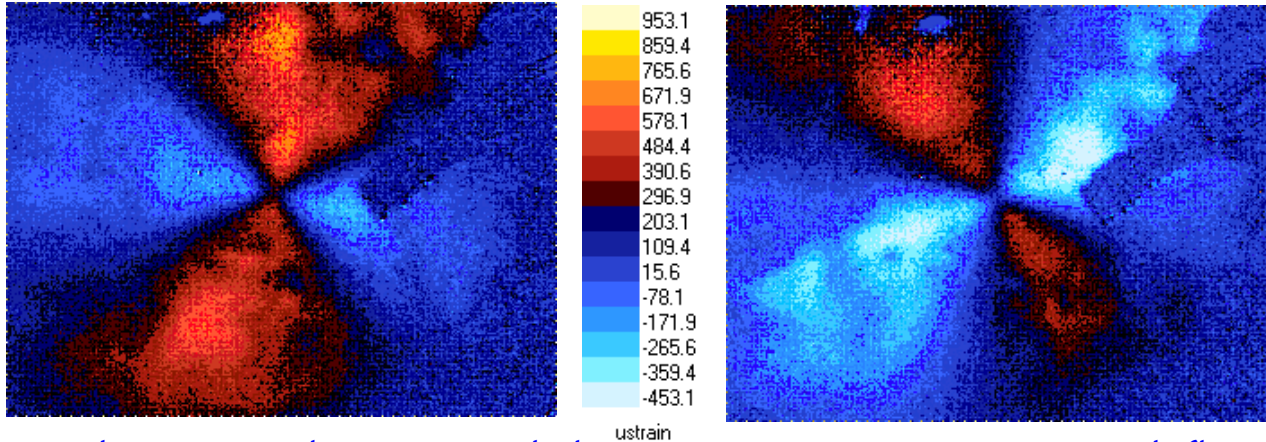

Windscreen 2: Shear 45 and Shear 0 Strain images at 4mm deflection

Typical offset loading results

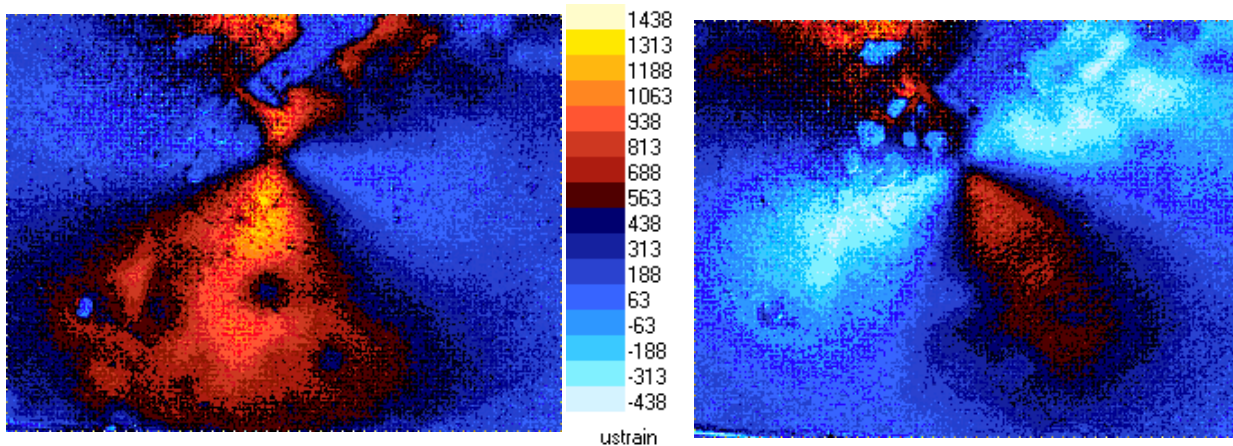

Windscreen 6: Shear 45 and Shear 0 Strain images at 10mm deflection



Drop Testing

- 6 windscreens in drop test:
 - 3 at centre
 - 3 at lower edge, 75mm from inner edge of bonded area.
- All impacts:
 - repeat tests all comparable.
 - after total glass failure, load is controlled by PVB layer.
 - Acceleration, load & displacement data recorded via accelerometer.
- Centre impact :
 - total glass failure occurred at $\approx 30\text{mm}$ displacement.
 - after this, load is controlled by PVB layer.
- Edge impact:
 - total glass failure occurred at $\approx 20\text{mm}$ displacement.
 - after this, load is controlled by PVB layer.

135mm diameter impactor weighing 5kg

windscreen fully bonded onto rigid test rig.

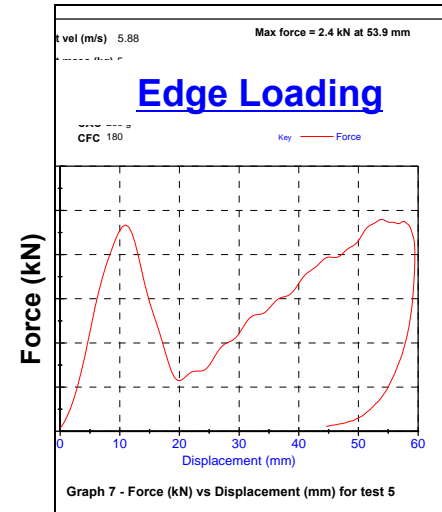
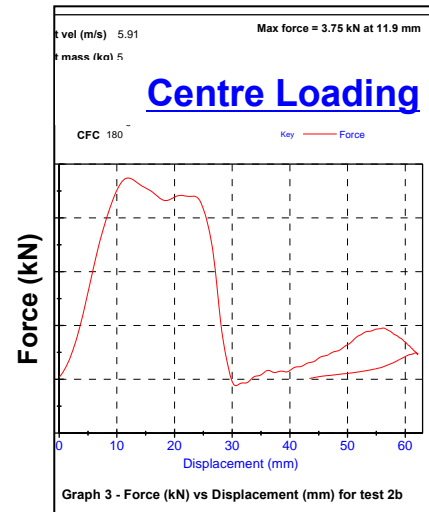
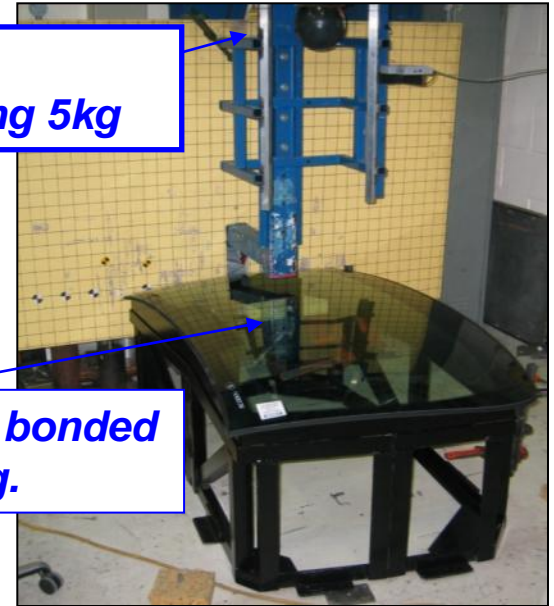

Windscreen Impact Testing

- Dynamic head impacts performed on Vehicle 1 windscreens mounted in-vehicle, setup to exclude 2ndary impact
- Performed with 4.5kg head @ 40kph, as EuroNCAP
- 2 impact pos: AH2 = windscreen centre AH1 = 200mm inboard from A-pillar
- 3 tests done per impact position

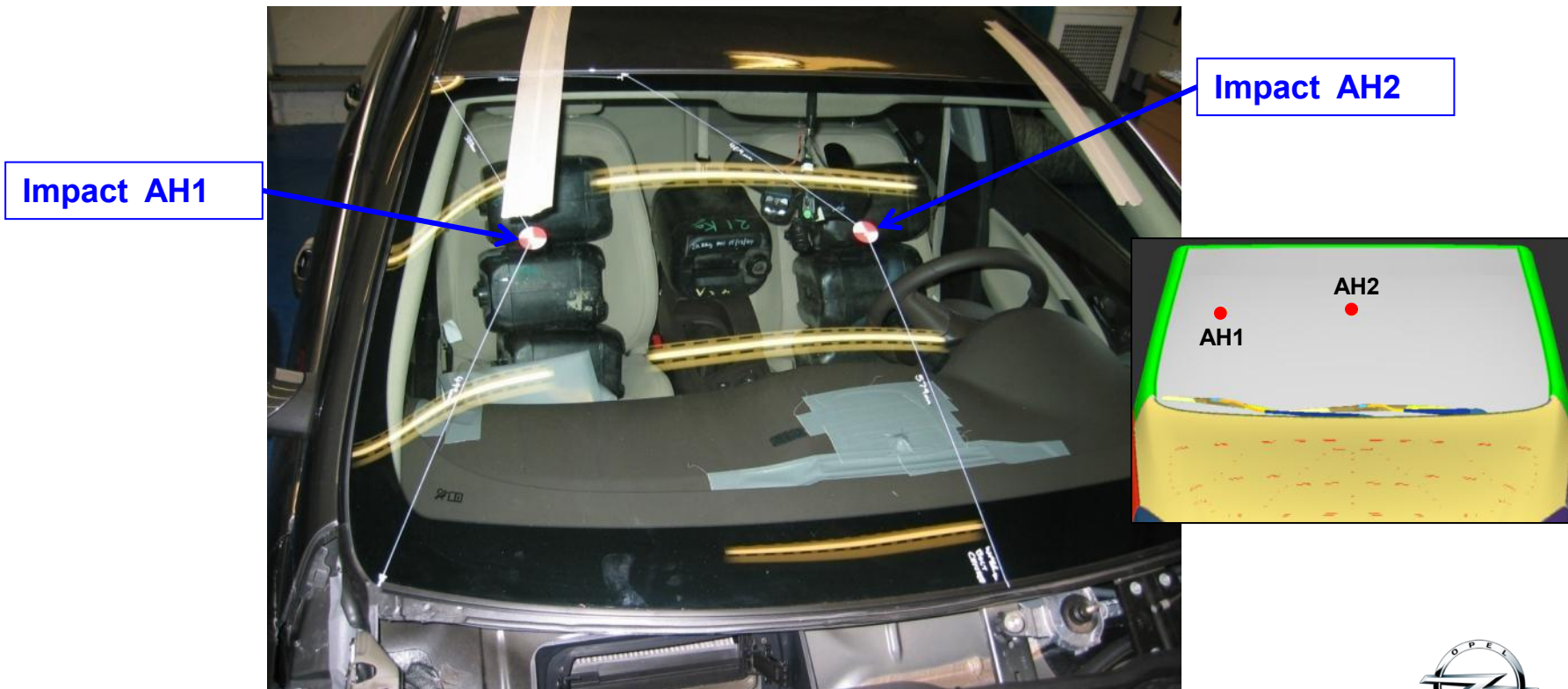

Windscreen Impact Test @ AH1

- 3 tests at AH1 (200mm inboard from A-pillar)
- Early high initial peaks then acceleration drops very quickly as windscreen fractures
- Test AH1-2 has 1 high peak, then glass fractures; tests AH1-1 & AH1-3 have 2 lower, narrower peaks – outer layer fractures 1st, then inner.

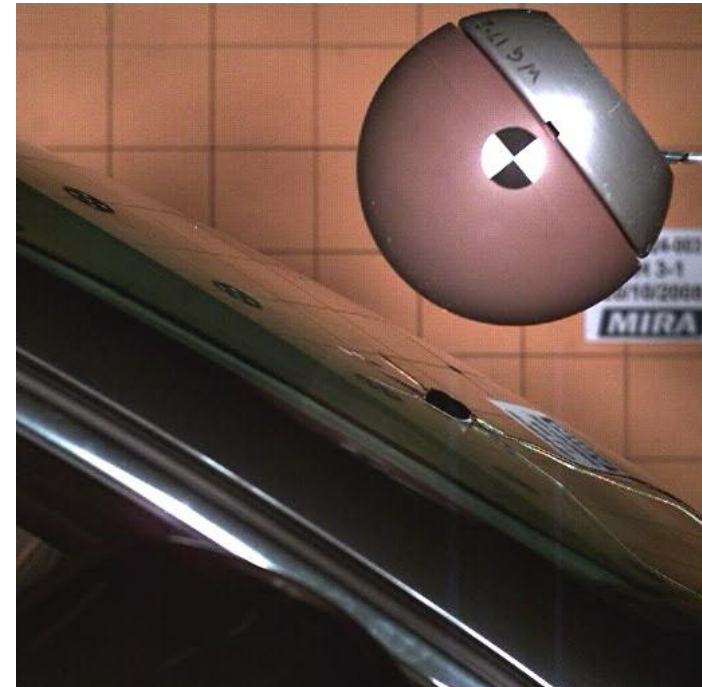
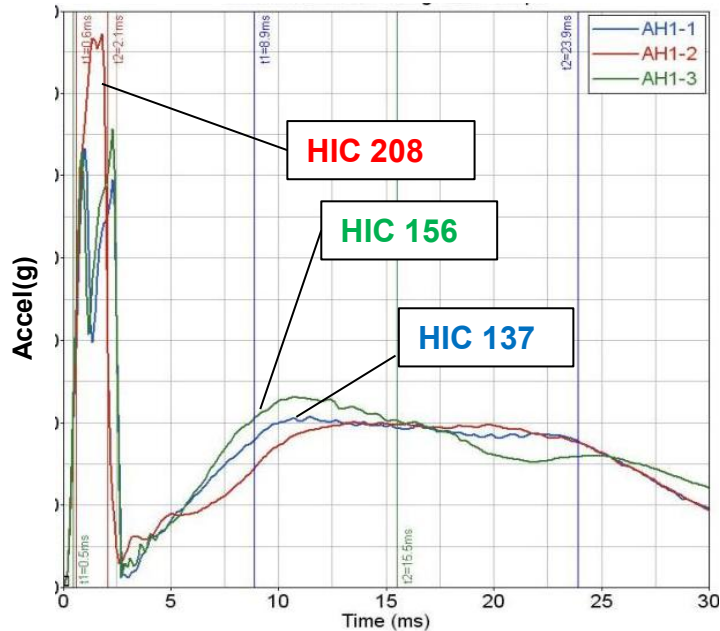
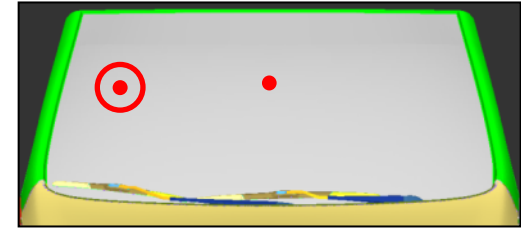

Windscreen Impact Test @ AH2

- 3 tests at AH2 (windscreen centre)
- all 3 tests have 2 early narrow peaks – outer layer fractures 1st, then inner.

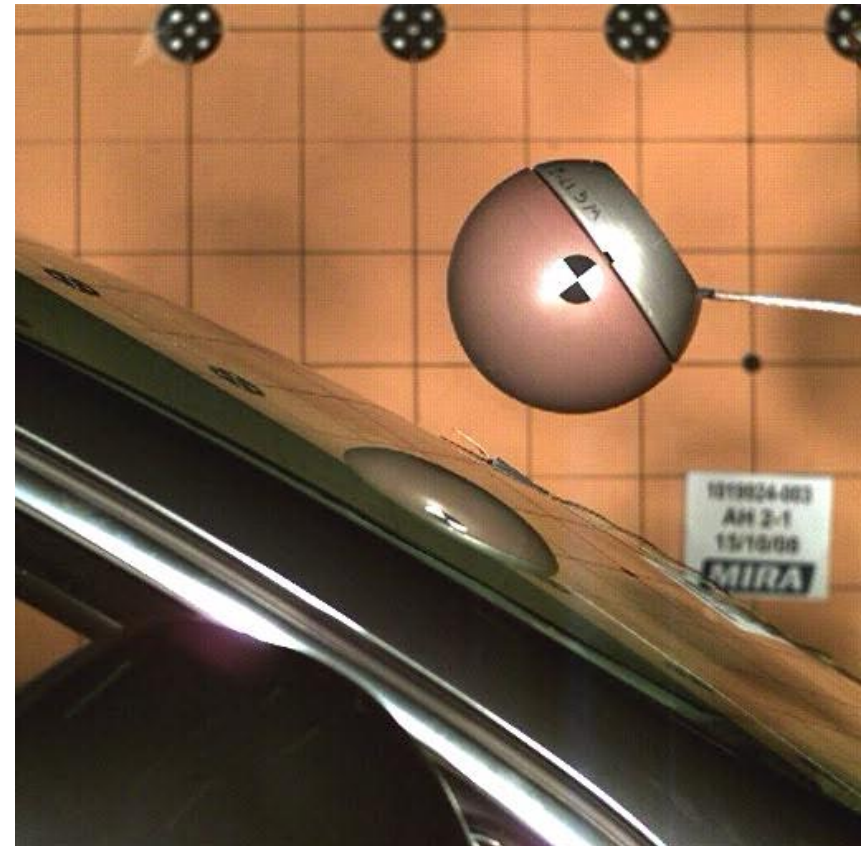
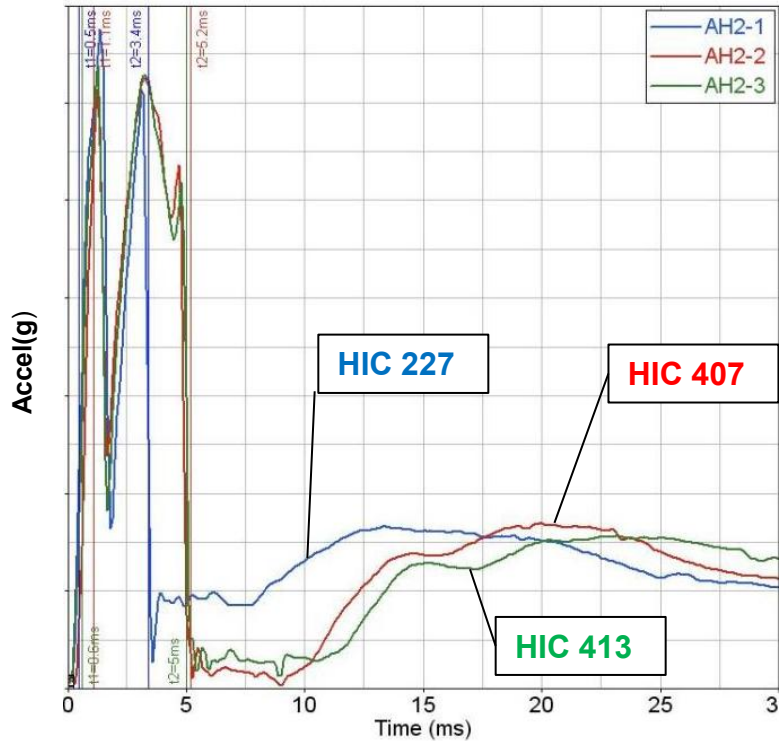
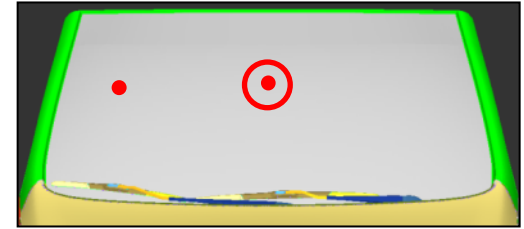

CAE Model for Windscreen Impact

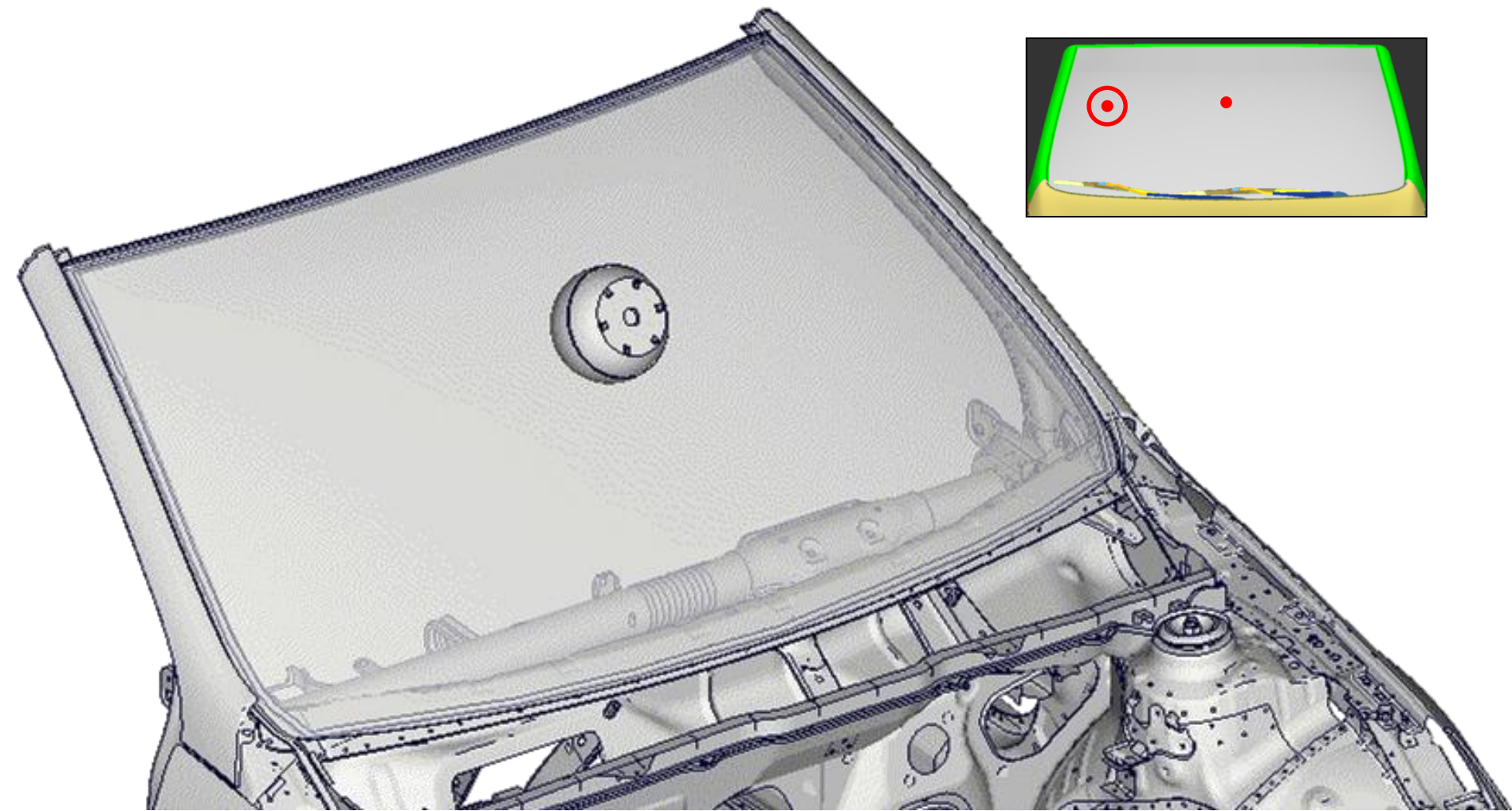

Windscreen Modelling Details

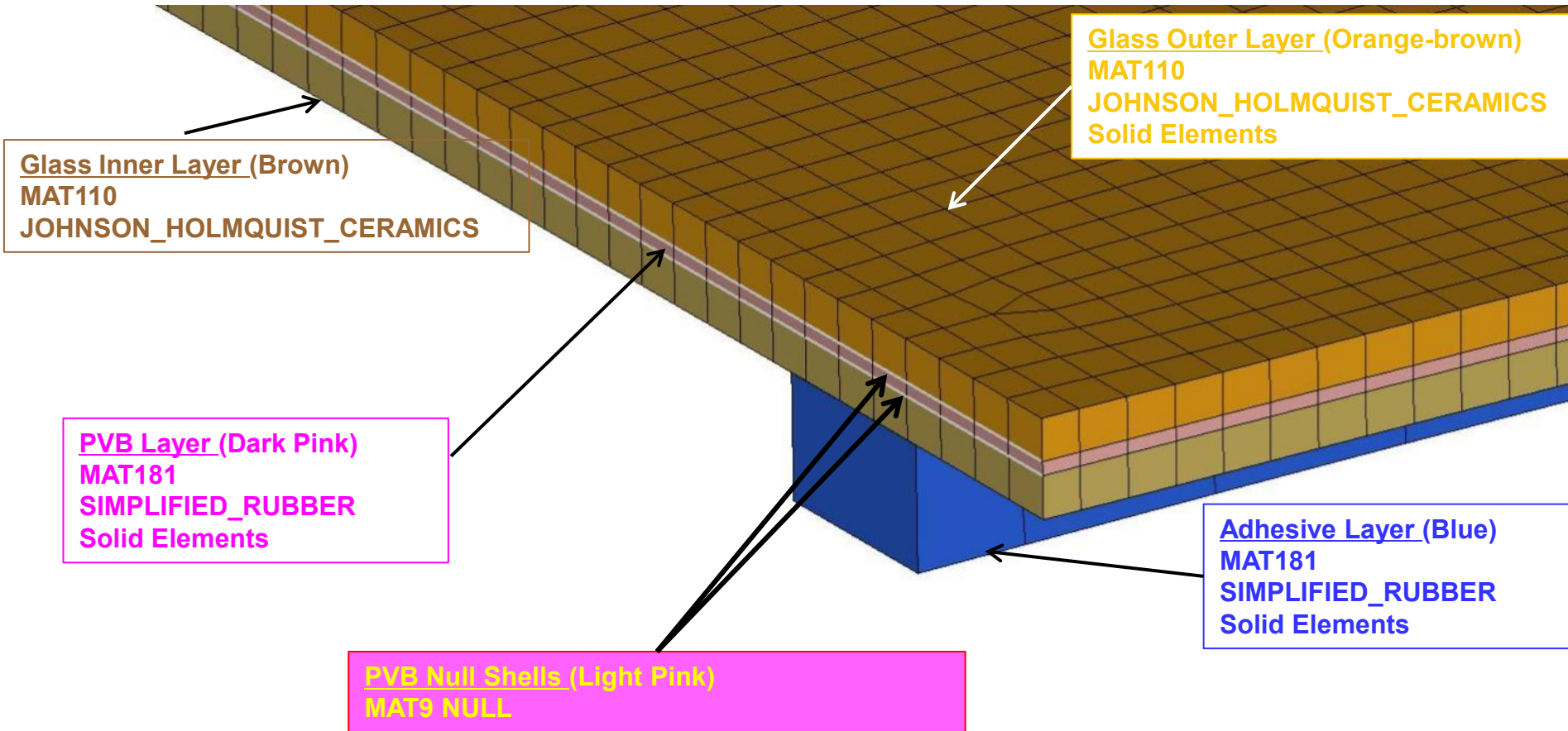

Additional Windscreen Modelling Detail

- **Glass and PVB (including Null Shells) joined by equivalent nodes**
- **Contact between Null Shells modelled as CONTACT_SINGLE_SURFACE**
- **Adhesive tied to glass using CONTACT_SPOTWELD card**
- **PVB and adhesive models are hyper-elastic materials with tension and compression curves specified at various rates.**
- **Glass parameter values in Johnson_Holmquist material cards are based on published data from reports. Parameters, especially fracture-related were tuned v. component & full vehicle tests.**



Vehicle 1 (w/o Package)

Radial crack-lines:
important for
fracture
propagation

Tangential crack-
lines: important in
reducing stiffness
of glass in tension

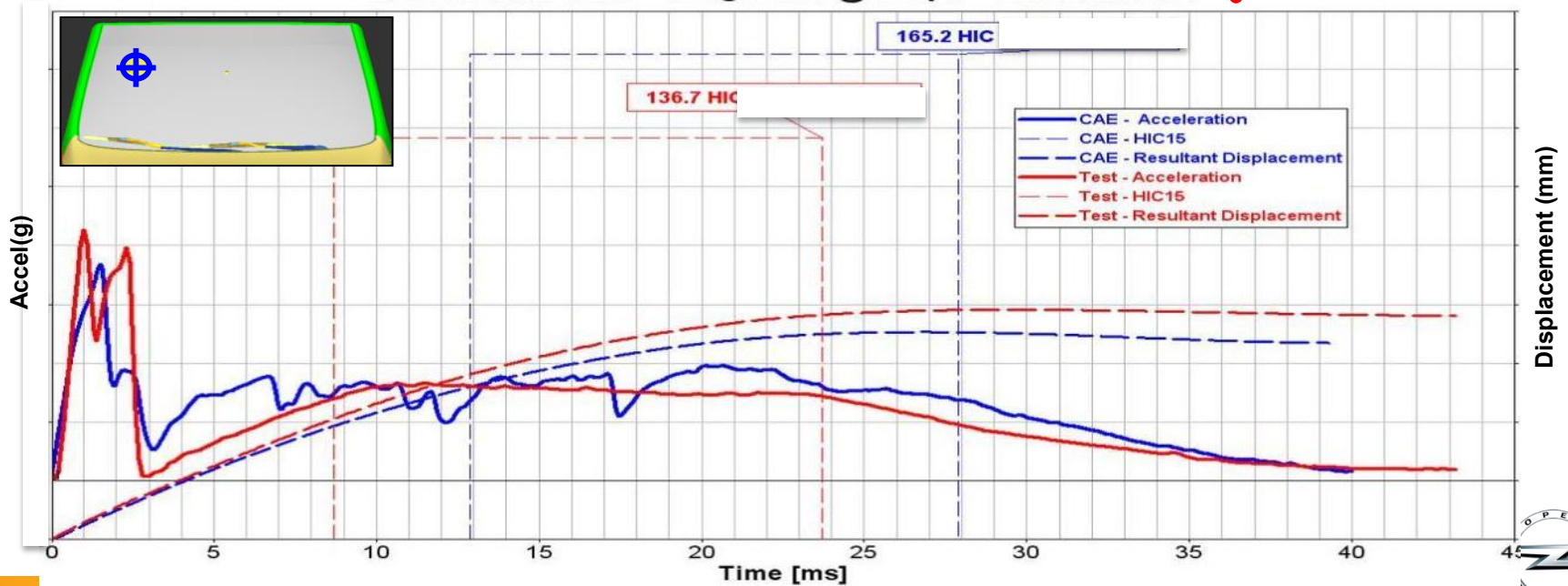
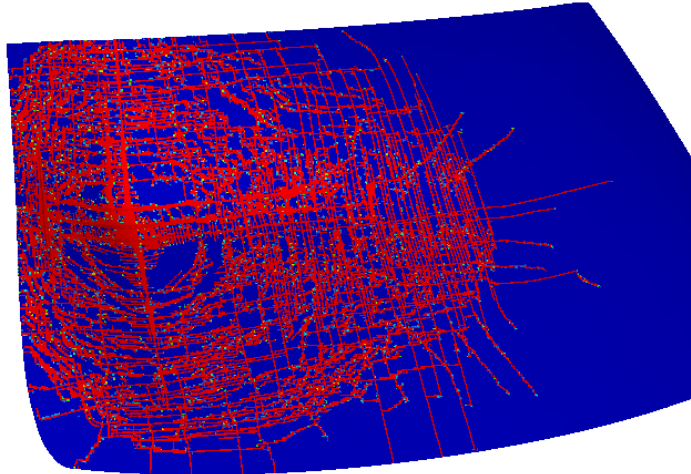

Vehicle 2 (w/o Package)

New CAE Method / Traditional Method / Test

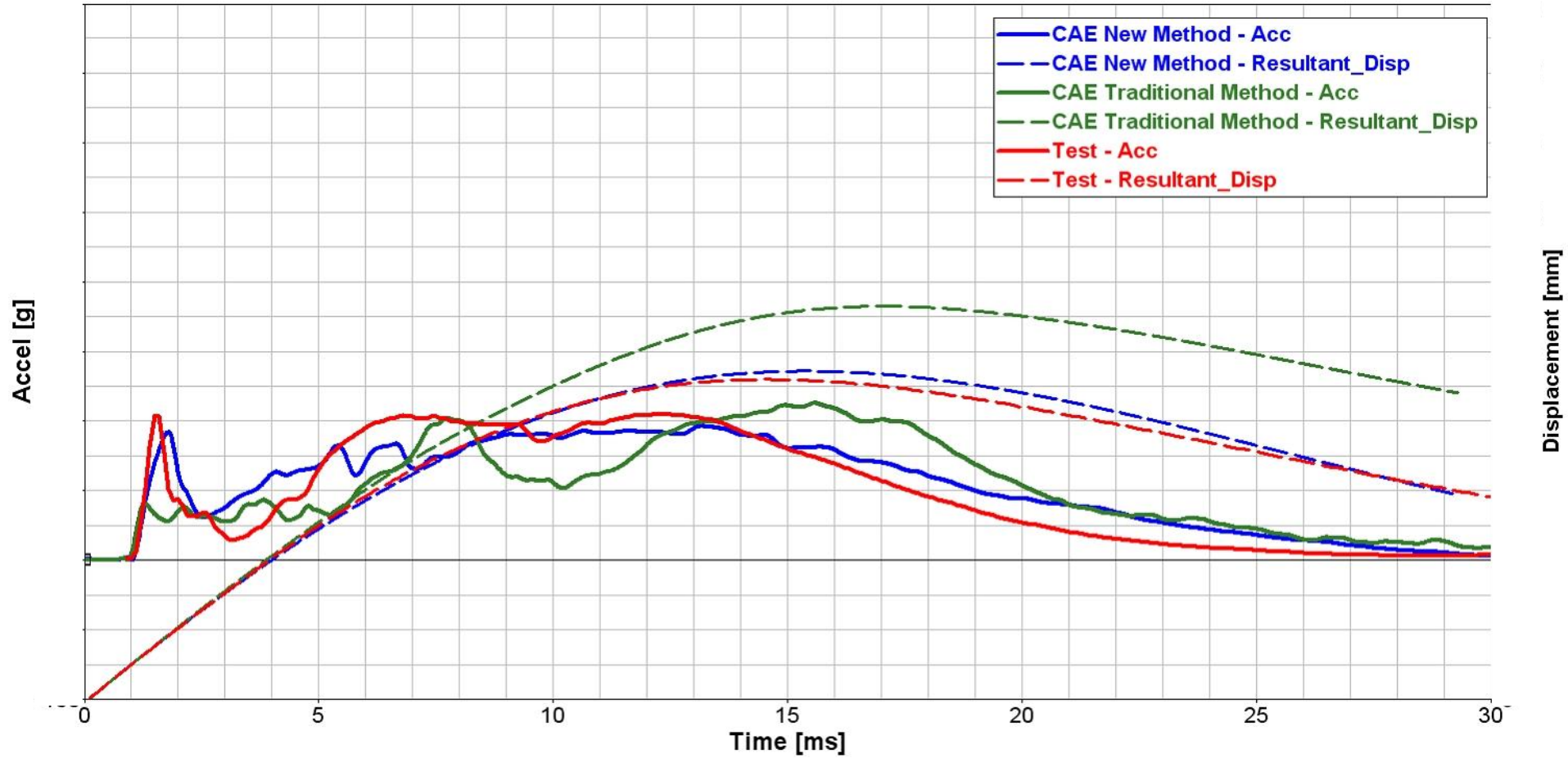

Wir leben Autos.

Vehicle 2 (no 2ndary Impact)

Radial crack-lines:
important for
fracture
propagation

Tangential crack-
lines: important in
reducing stiffness
of glass in tension

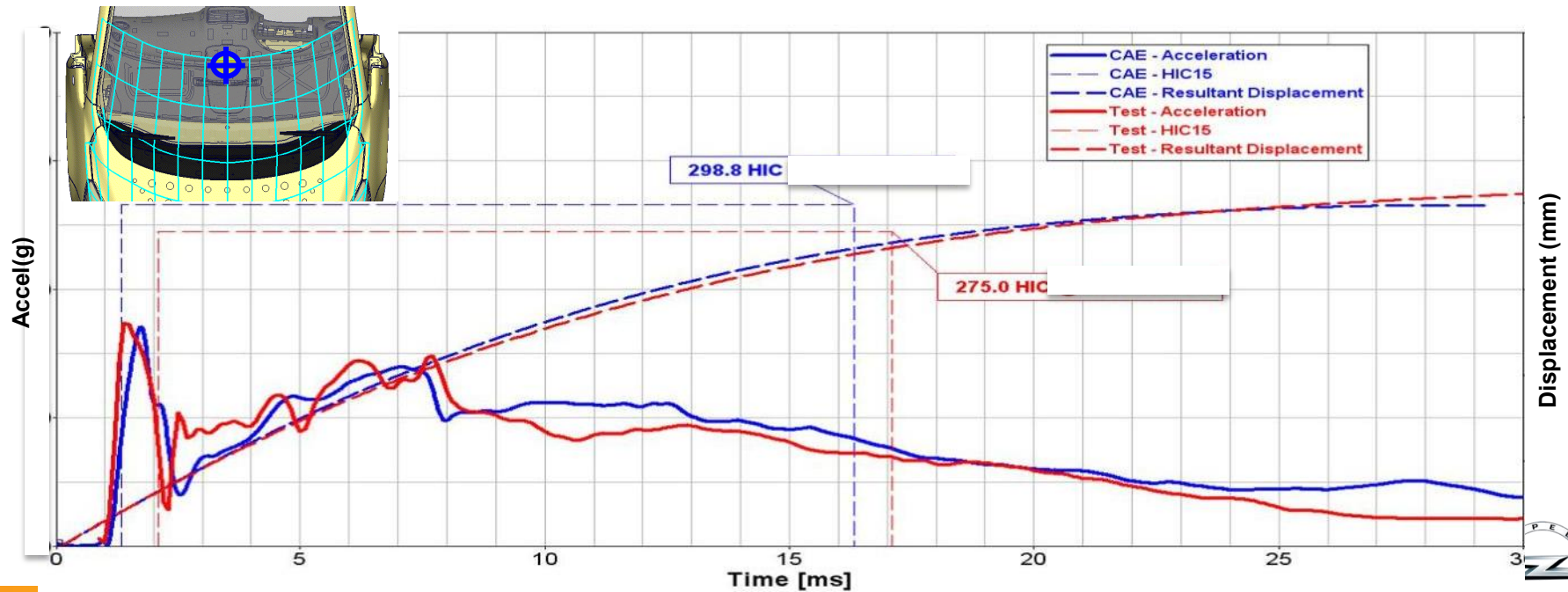
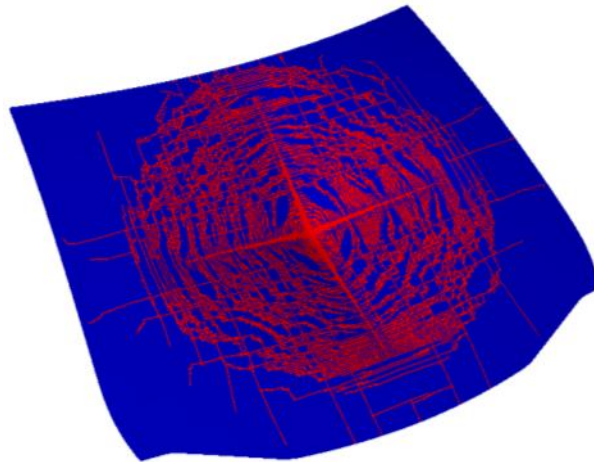

Vehicle 2 Test / CAE (2ndary Impact)

Radial crack-lines:
important for
fracture
propagation

Tangential crack-
lines: important in
reducing stiffness
of glass in tension

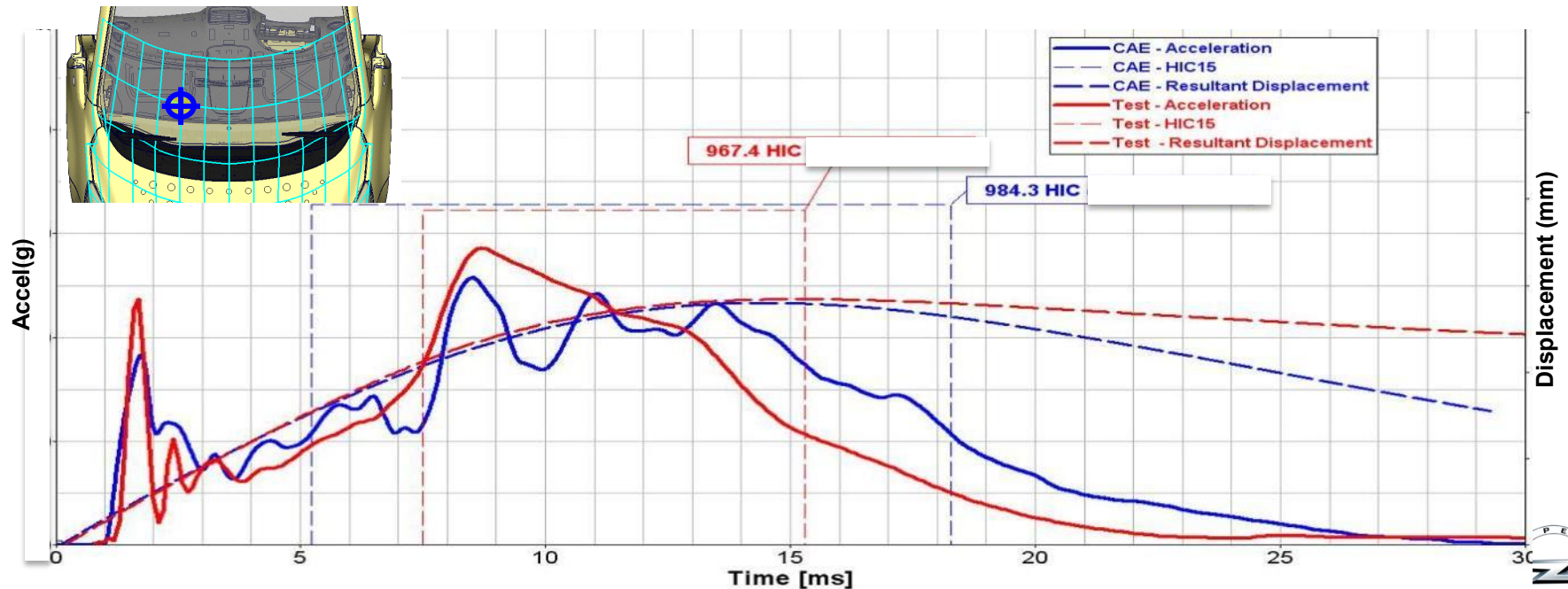
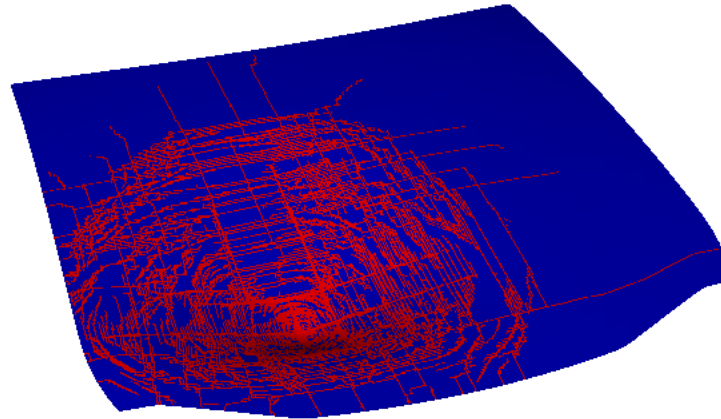

Vehicle 2 Test / CAE (2ndary Impact)

Radial crack-lines:
important for
fracture
propagation

Tangential crack-
lines: important in
reducing stiffness
of glass in tension

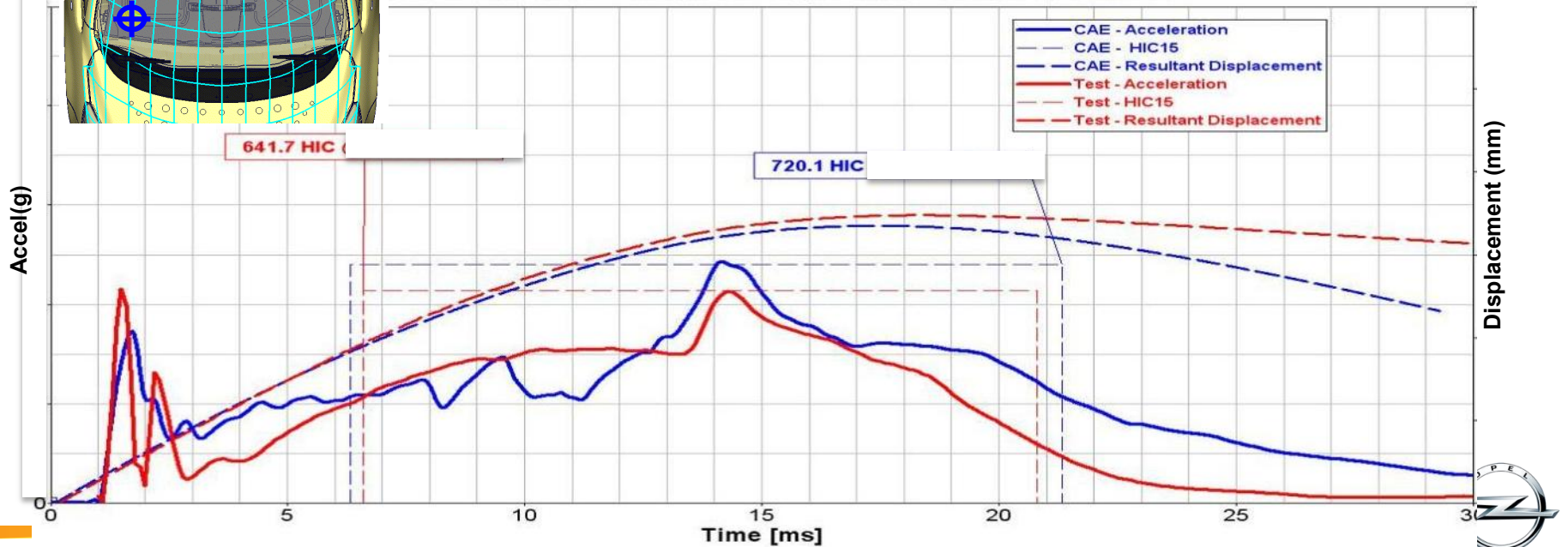
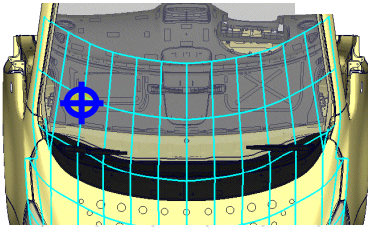
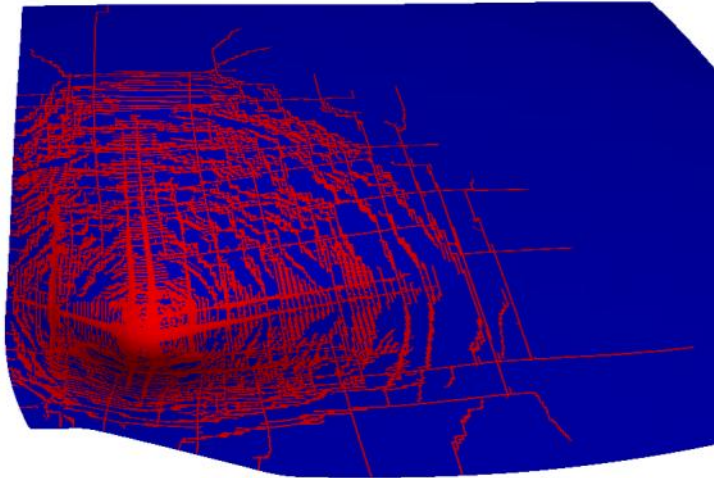

Effect of Edge Stresses:

CAE with / CAE Without Edge Stresses

Edge stresses added for both inner & outer glass layers

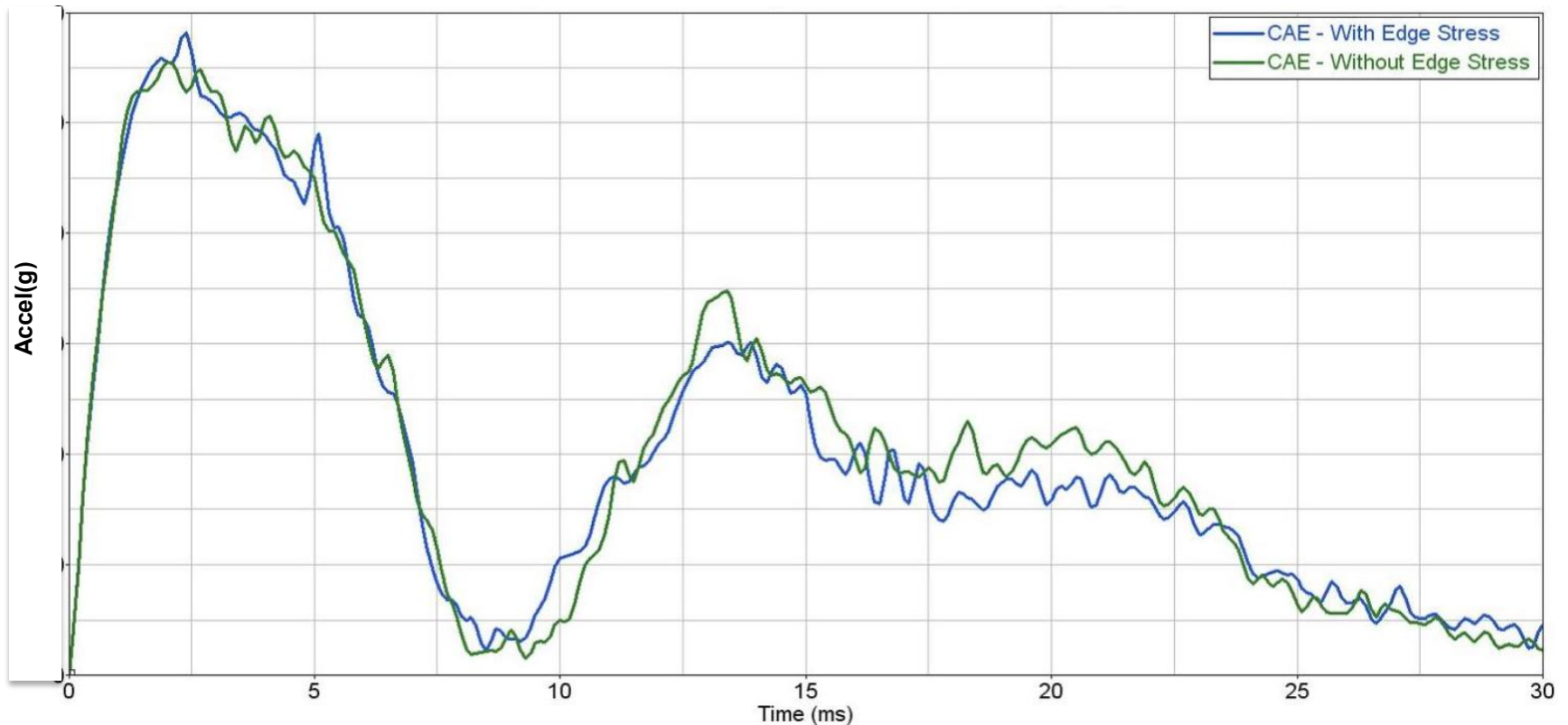

Edge effects were NOT significant for acceleration

⇒ Good for predictive quality



Summary

- ✓ PVB coupon model
- ✓ Adhesive model
- ✓ Windscreen model for quasi-static tests
- ✓ Quasi-static windscreen model for drop test
- ✓ Technique developed to input photo-elastic output as pre-stressing into windscreen (dyna_in file)
- ✓ Option of Vehicle 1 pre-stress test / CAE data to pre-condition windscreen for impact simulation
- ✓ Added parameters from windscreen manufacturing process to model
- ✓ Investigated mesh size sensitivity – refined initial mesh x 4, x 16

Final Correlation Head Impacts v. Windscreen

- ✓ Optimum “3-layer” methodology for inner glass, PVB, outer glass developed
- ✓ Optimum mesh size determined for all 3 windscreen layers and adhesive
- ✓ Optimum element type , HG, # integration pts determined – solids for all layers
- ✓ Optimum static & dynamic friction values determined
- ✓ Realistic “fracture lines” radially & tangentially
- ✓ Optimum material laws determined for PVB and Adhesive (MAT181 simplified rubber) and inner & outer glass layers (MAT110 MAT_JOHNSON_HOLMQUIST_CERAMICS), – also tried but not as good: MAT24, MAT 17 (ORIENTED_CRACK), MAT_BRITTLE_DAMAGE
- ✓ Material parameters tuned for test correlation
- ✓ Effect of pre-stressing assessed - found to be small





Wir leben Autos.