

The interaction between LS-OPT, ANSA and μ ETA

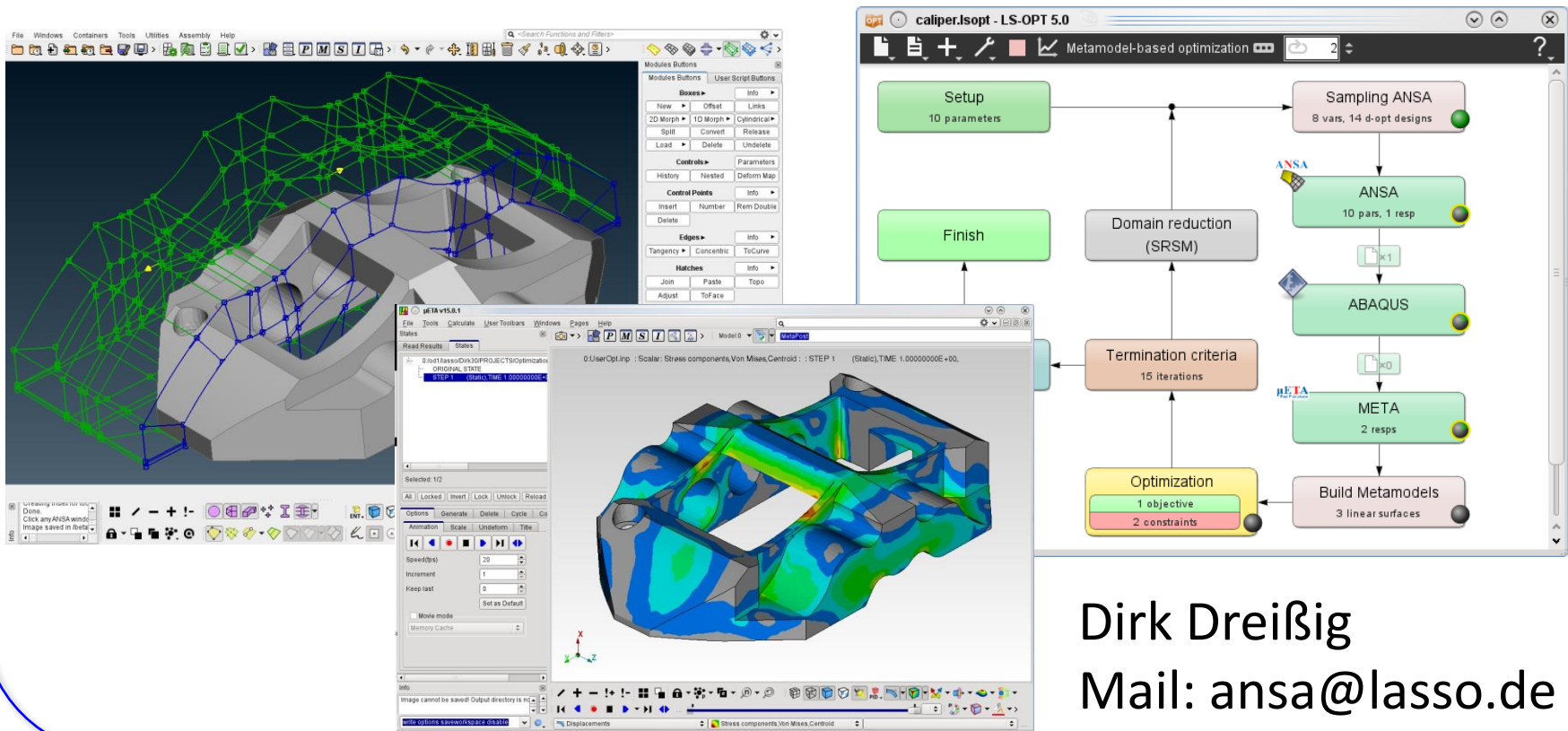

Dirk Dreißig
Mail: ansa@lasso.de

For what **ANSA** & **μETA**?

For what **ANSA** & **μETA**?

- **ANSA** for model-change according to design variables (everything besides LS-DYNA with *PARAMETER)

For what **ANSA** & **μETA**?

- **ANSA** for model-change according to design variables (everything besides LS-DYNA with *PARAMETER)
- **μETA** for results extraction of arbitrary (supported) solvers (besides LS-DYNA)

For what ANSA & μ ETA?

- **ANSA** for model-change according to design variables (everything besides LS-DYNA with *PARAMETER)
- **μ ETA** for results extraction of arbitrary (supported) solvers (besides LS-DYNA)
- **Setup phase**
 - design variables defined in **ANSA** → transfer to LS-OPT
 - histories and responses defined in **μ ETA** → transfer to LS-OPT

For what ANSA & μ ETA?

- **ANSA** for model-change according to design variables (everything besides LS-DYNA with *PARAMETER)
- **μ ETA** for results extraction of arbitrary (supported) solvers (besides LS-DYNA)
- **Setup phase**
 - design variables defined in **ANSA** → transfer to LS-OPT
 - histories and responses defined in **μ ETA** → transfer to LS-OPT
- **Optimization (Run) phase**
 - design variables controlled by LS-OPT → transfer to **ANSA**
 - histories and responses calculated by **μ ETA** → transfer to LS-OPT

Optimization Setup

ANSA → Solver → META → LS-OPT

Optimization Setup

ANSA → Solver → META → LS-OPT

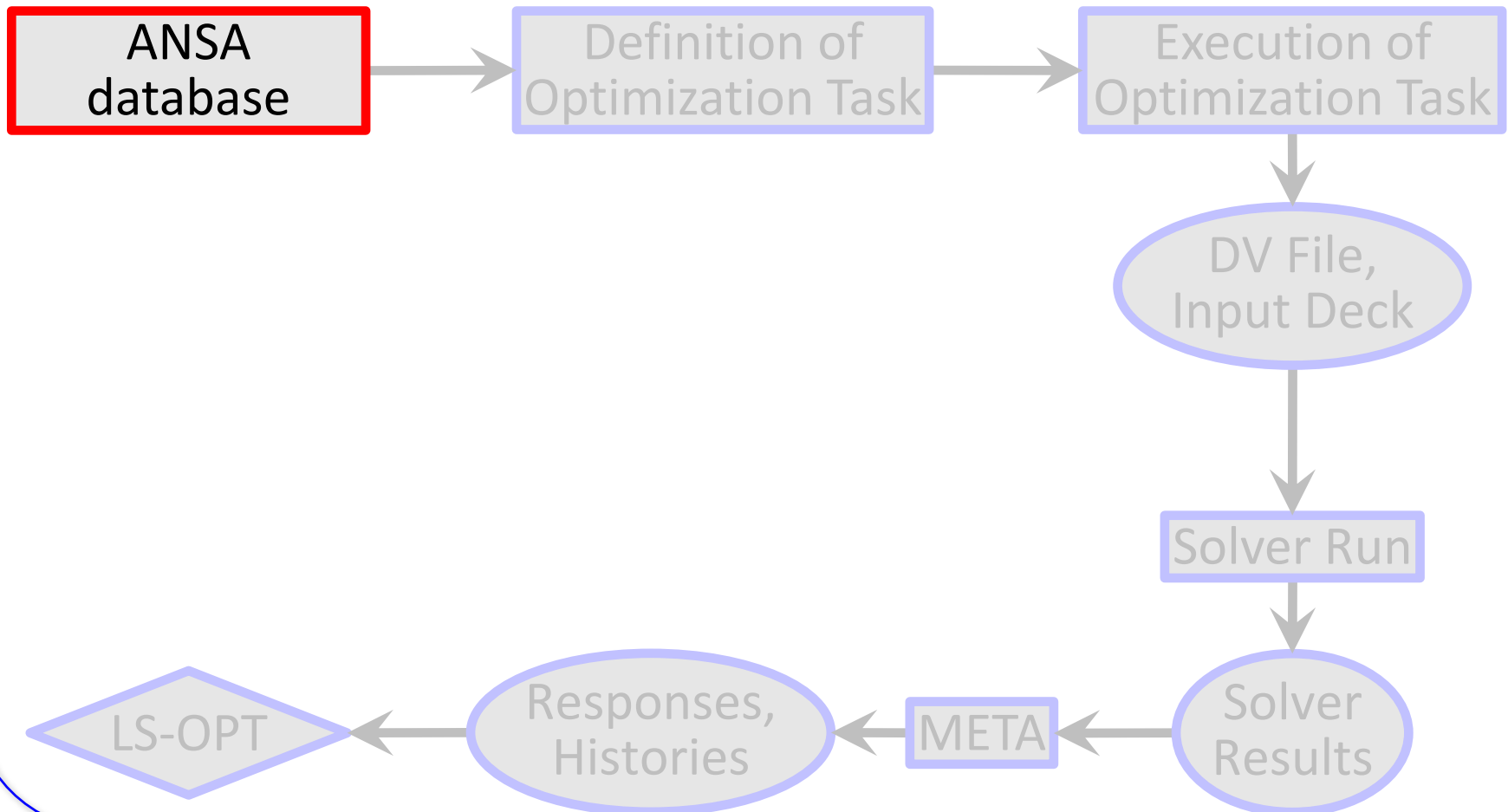

Optimization Setup

ANSA → Solver → META → LS-OPT

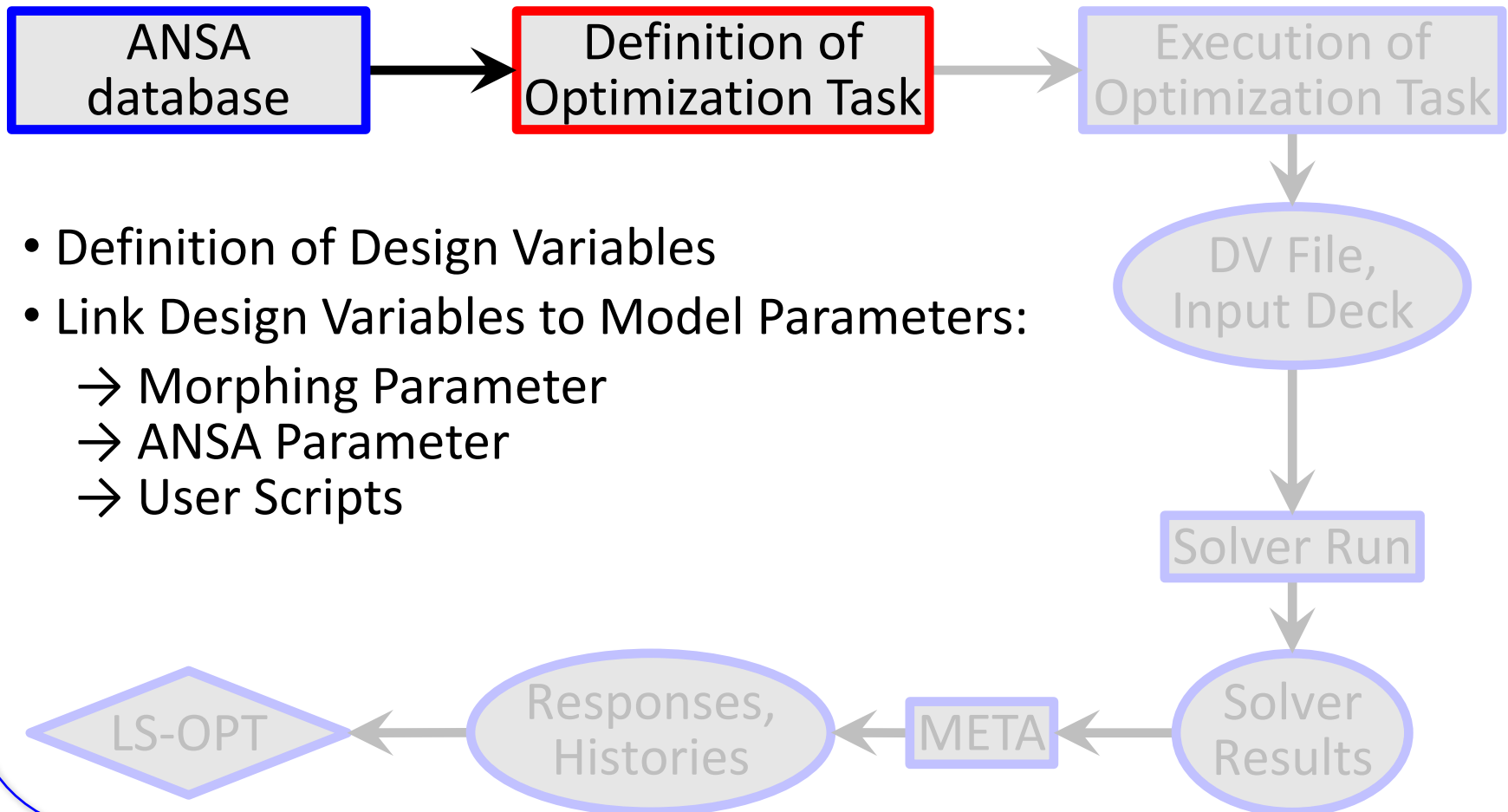

Optimization Setup

ANSA → Solver → META → LS-OPT

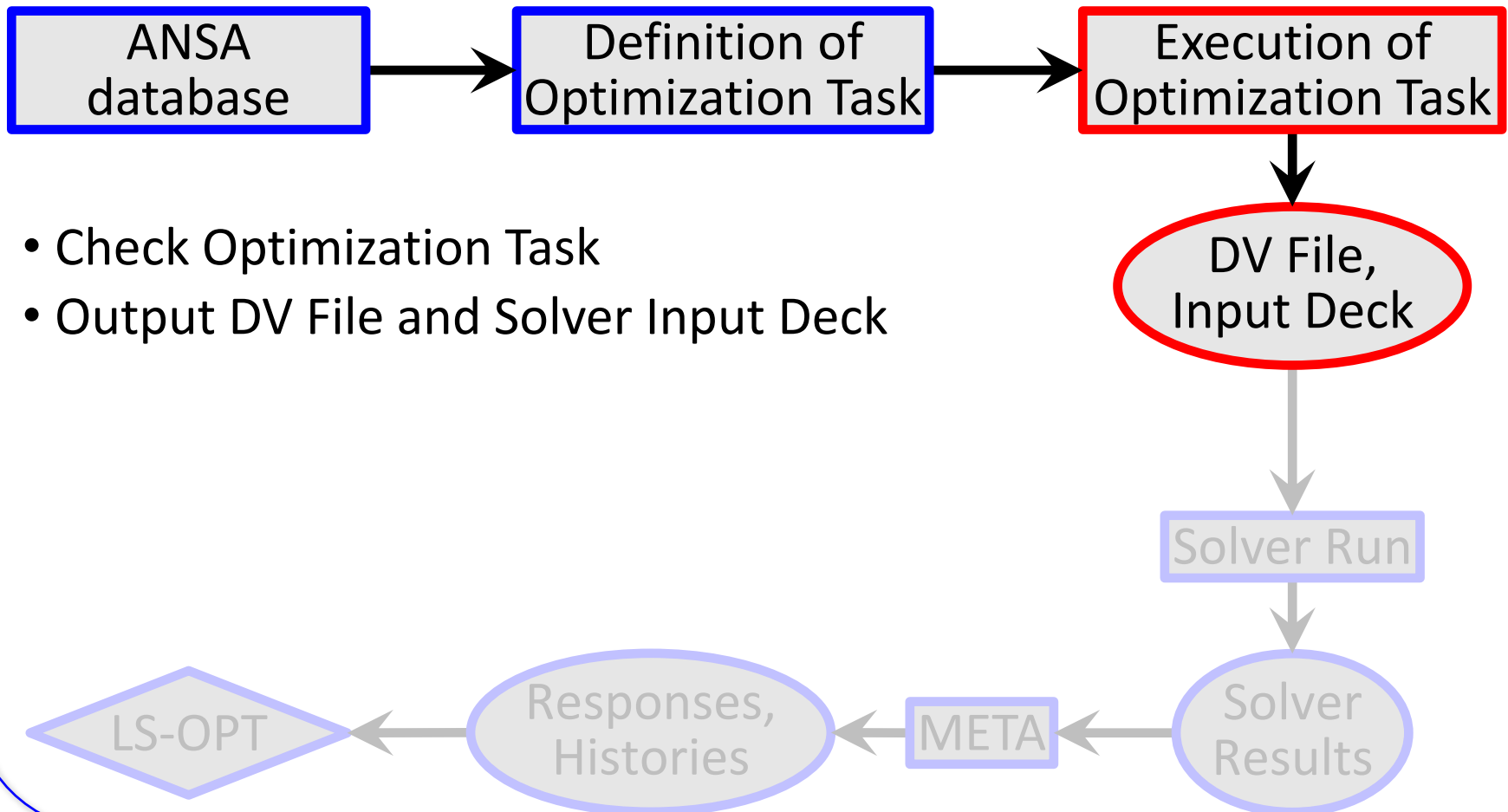

Optimization Setup

ANSA → **Solver** → META → LS-OPT

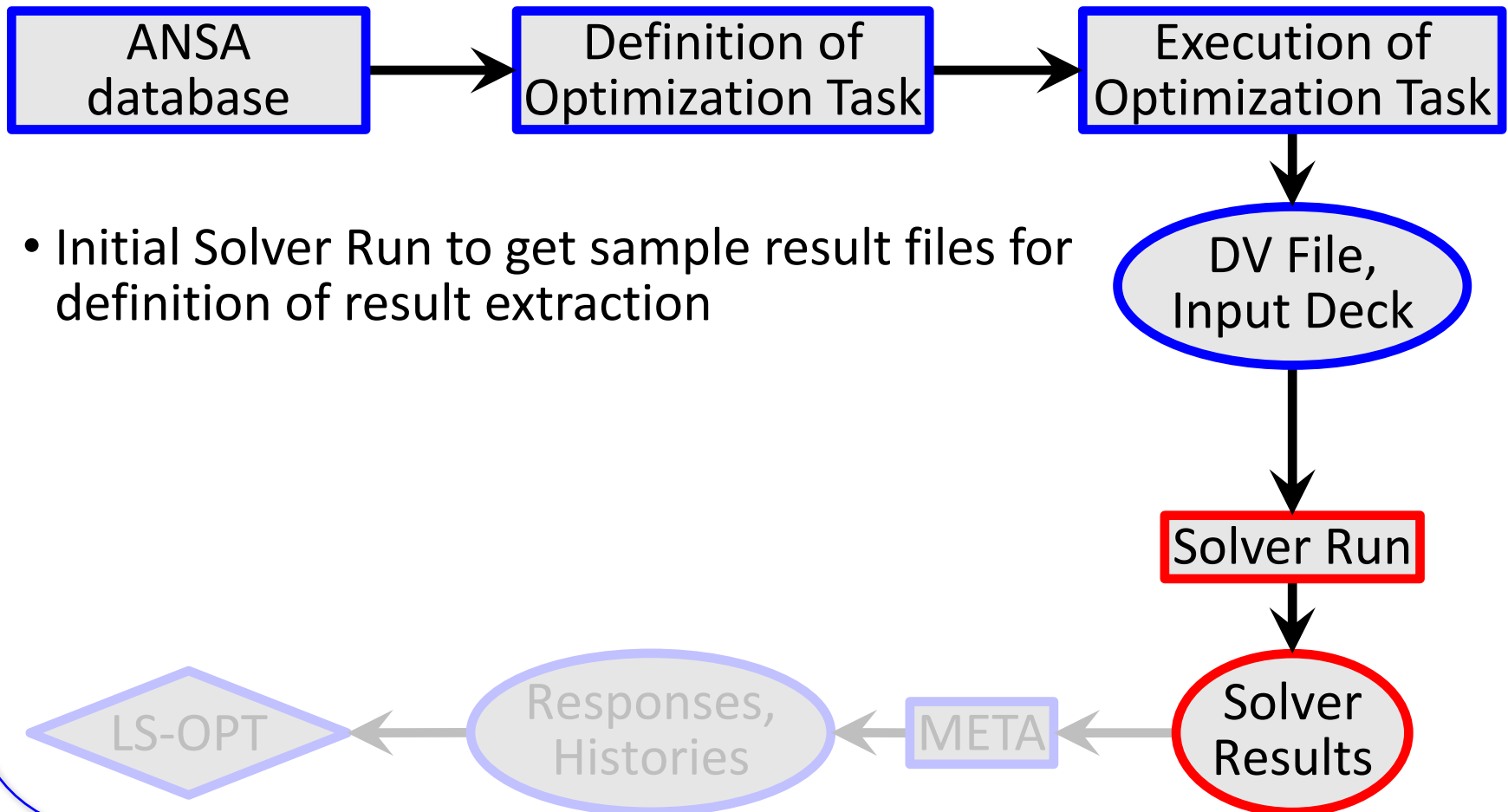

Optimization Setup

ANSA → Solver → **META** → LS-OPT

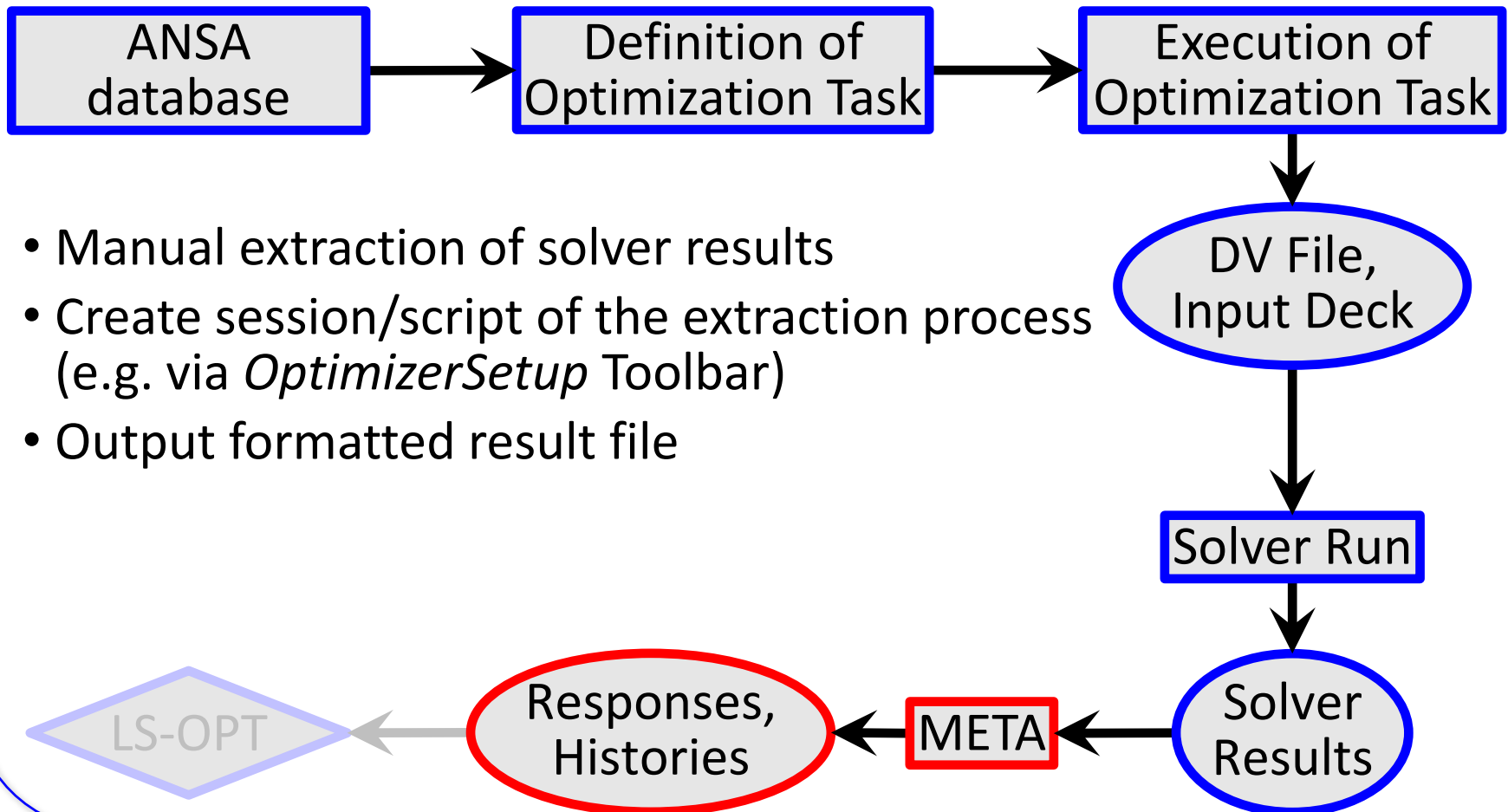

Optimization Setup

ANSA → Solver → META → **LS-OPT**

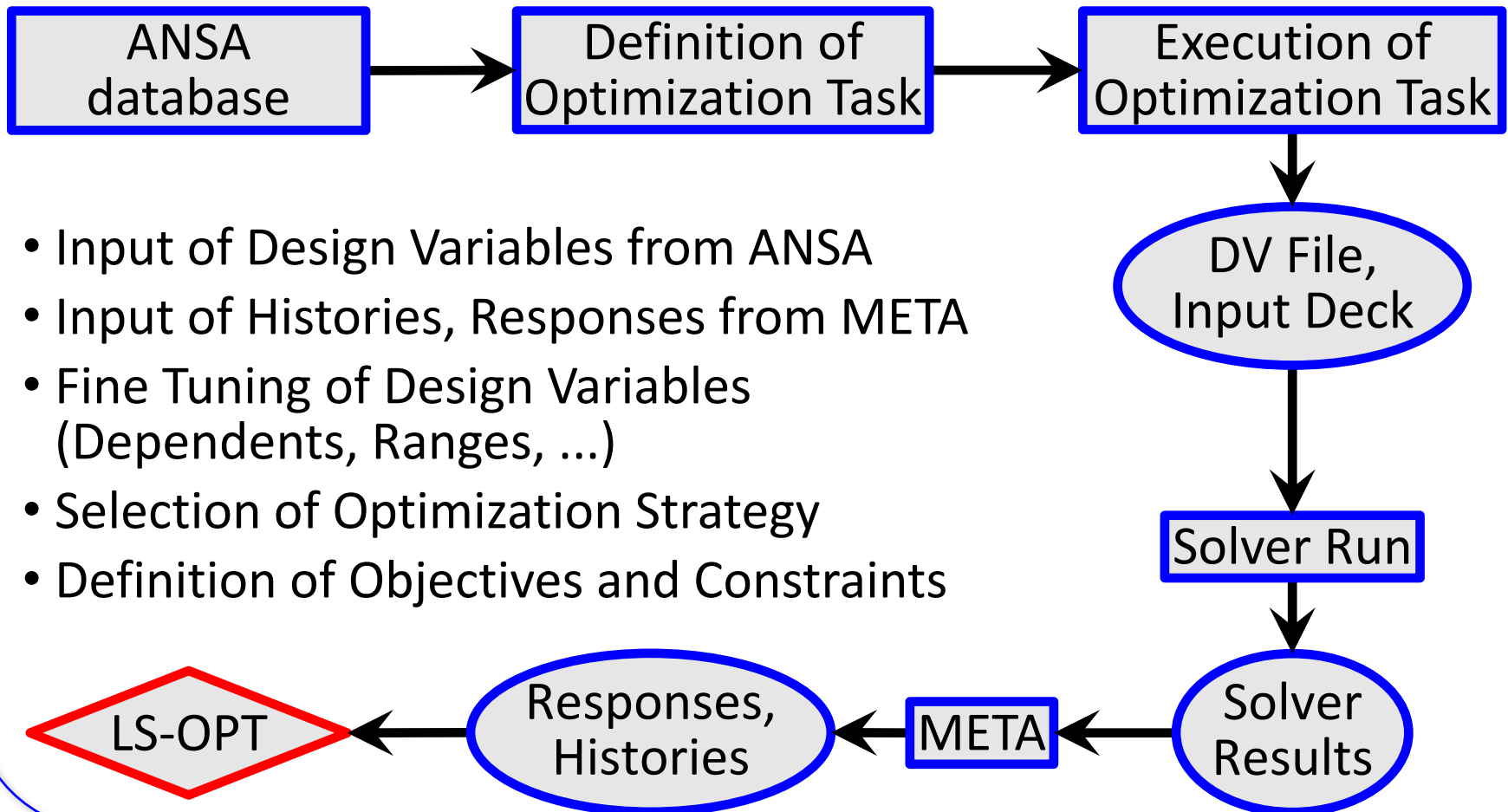

ANSA – Optimization Task

3 main task items

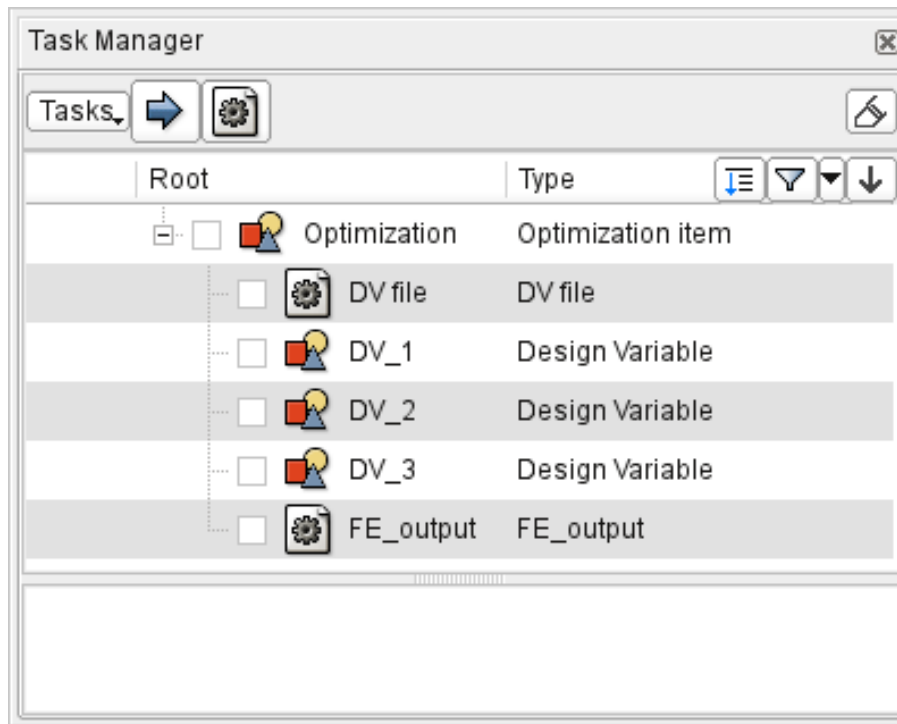

ANSA – Optimization Task

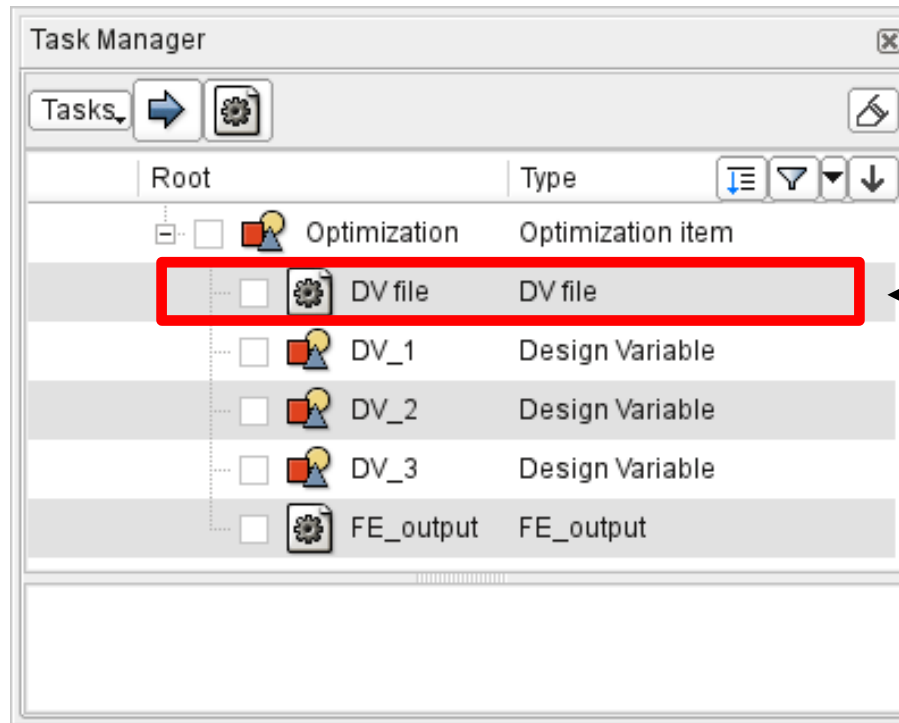

3 main task items

← **1. Design Variable File**

ANSA – Optimization Task

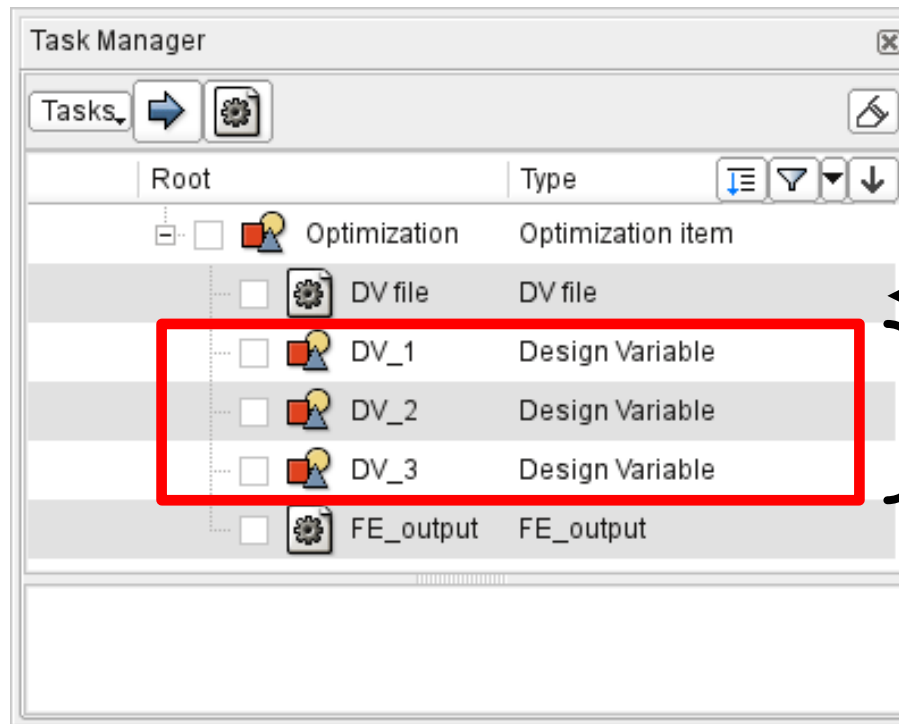

3 main task items

1. Design Variable File

2. Design Variables

ANSA – Optimization Task

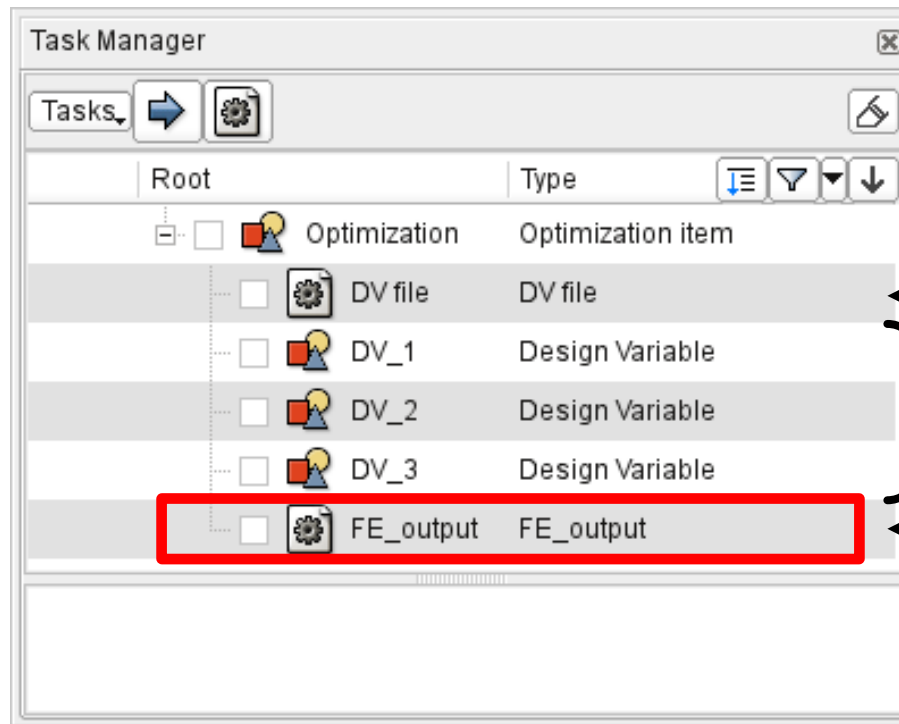

3 main task items

1. Design Variable File

2. Design Variables

3. Output Solver Deck

ANSA – Optimization Task

Design Variable File

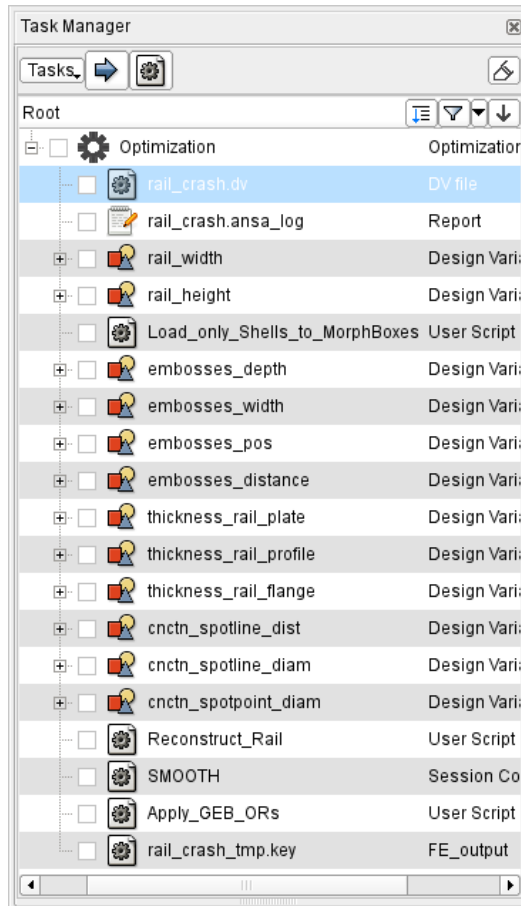

ANSA – Optimization Task

Design Variable File

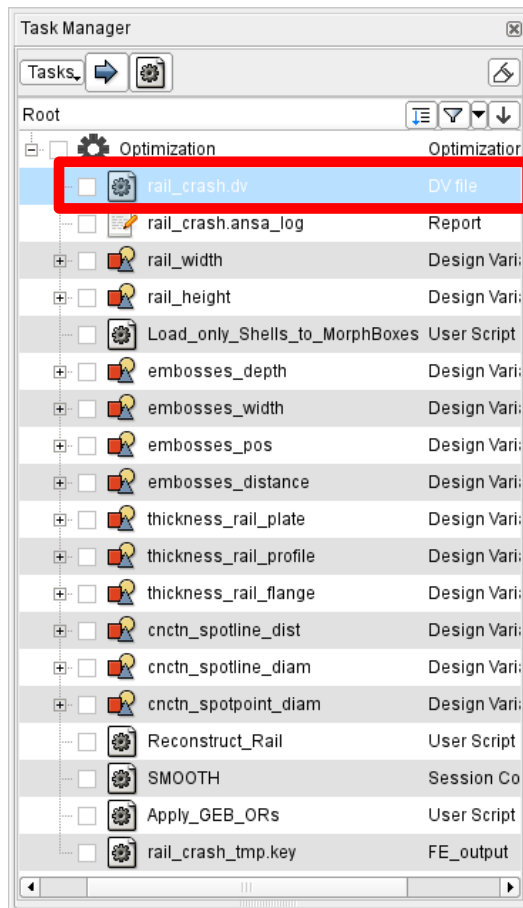

```
#
# ANSA_VERSION: 14.2.3
#
# file created by  A N S A  Mon Feb 17 17:13:25 2014
#
# Output from:
# /od1/lasso/Dirk30/PROJECTS/Optimierung_Rail_LS-OPT/Rail_MD0/rail_crash.ansa
#
# DESIGN VARIABLES
#-----
# ID | DESIGN VARIABLE NAME | TYPE | RANGE | CURRENT VALUE | MIN VALUE -->  MAX VALUE | STEP
#-----
10, rail_width, REAL,    BOUNDS,    10., -20., 20.
11, rail_height, REAL,   BOUNDS,    10., -20., 20.
1,  embosses_depth, REAL,   BOUNDS,    7.,  0., 7.
3,  embosses_width, REAL,   BOUNDS,    10., -10., 10.
2,  embosses_pos, REAL,    BOUNDS,   -15., -50., 20.
7,  embosses_distance, REAL,  BOUNDS,   -15., -15., 50.
4,  thickness_rail_plate, REAL,   STEP,      1.5, 0.5, 2.,  0.1
5,  thickness_rail_profile, REAL,   STEP,      1.5, 0.5, 2.,  0.1
8,  thickness_rail_flange, REAL,   STEP,      1.5, 0.5, 3.,  0.1
6,  cncntn_spotline_dist, REAL,   BOUNDS,    50., 20., 100.
9,  cncntn_spotline_diam, REAL,   STEP,      5.,  2., 10.,  1.
12, cncntn_spotpoint_diam, REAL,   STEP,      5.,  2., 10.,  1.
#-----
```

Correctly formatted for
import in LS-OPT

ANSA – Optimization Task

Design Variables → Morphing Parameters

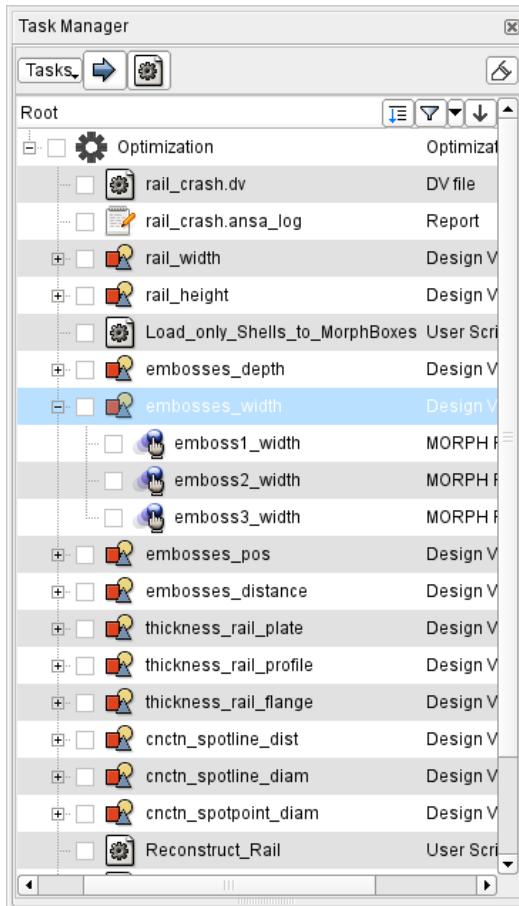

ANSA – Optimization Task

Design Variables → Morphing Parameters

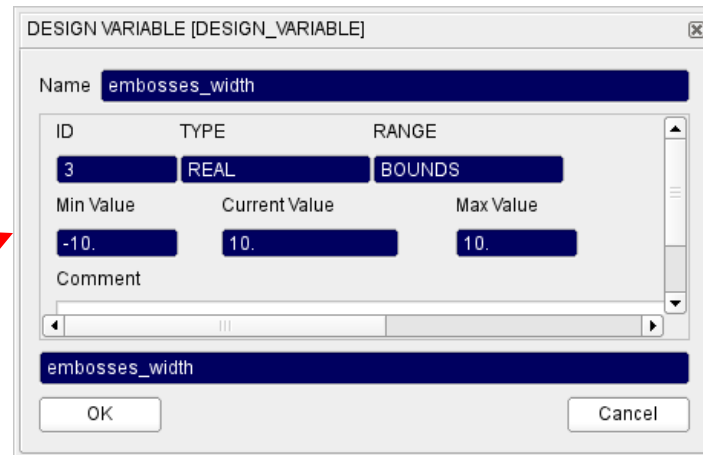
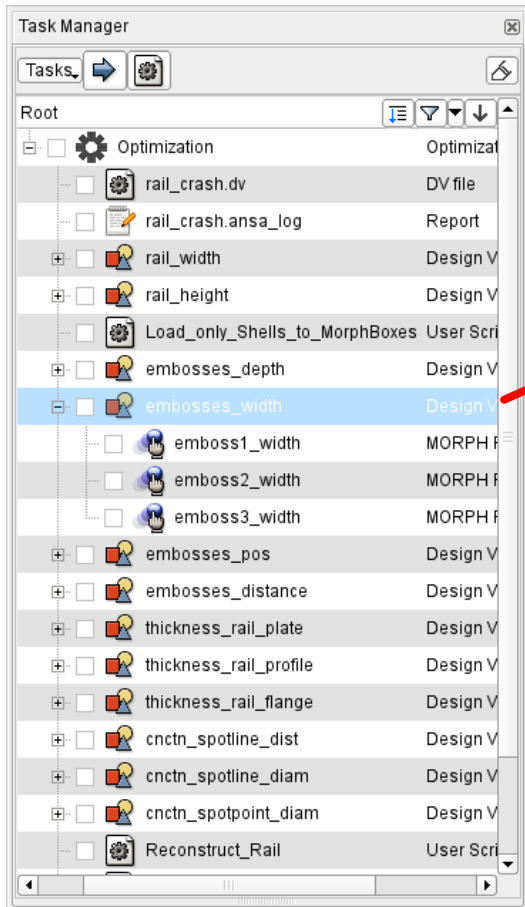

ANSA – Optimization Task

Design Variables → Morphing Parameters

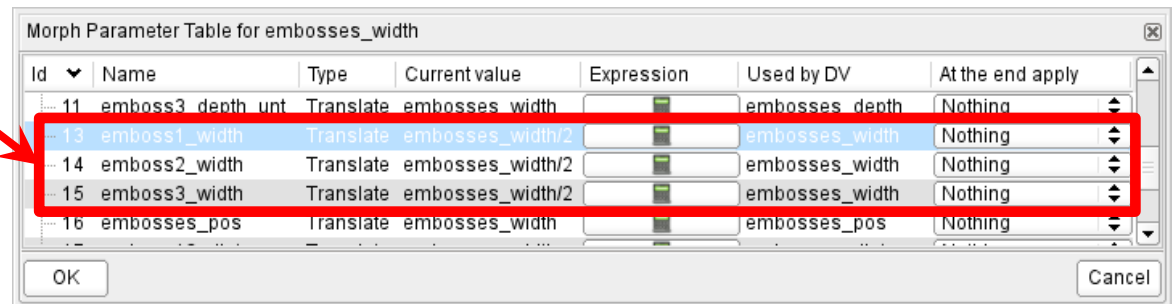
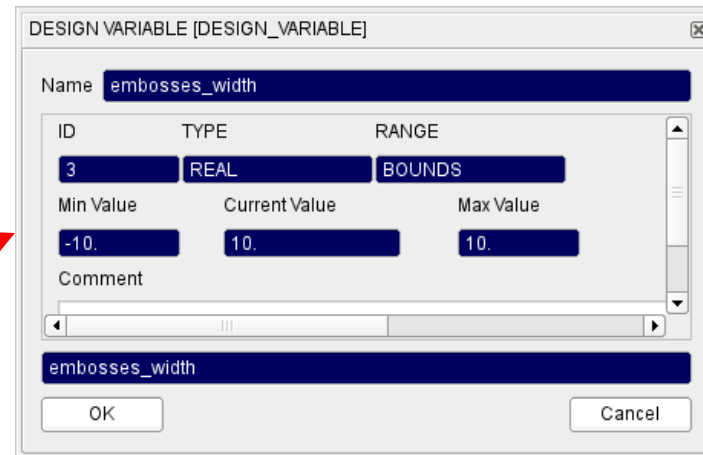
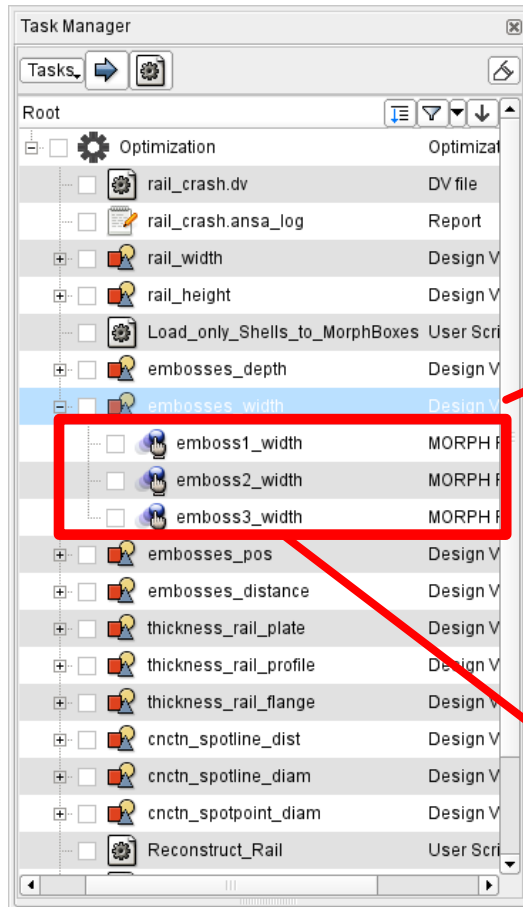

ANSA – Optimization Task

Design Variables → Morphing Parameters

Shape modification

Design Variable = 10.0

Morphing Parameter

Width of depressions

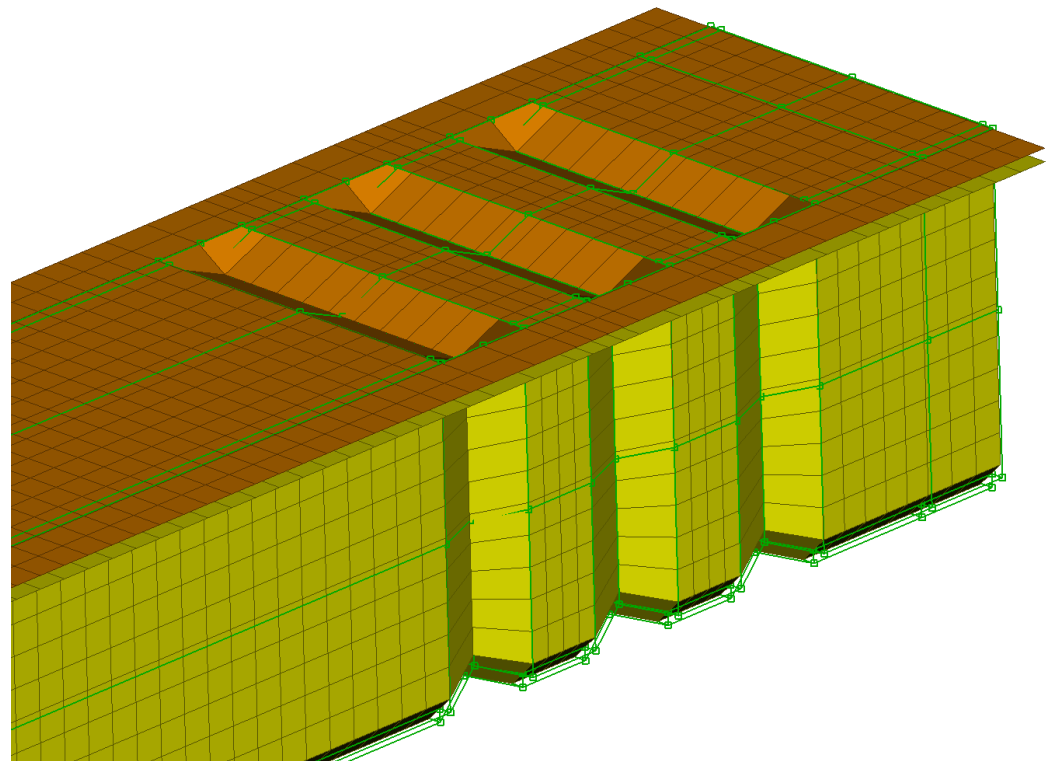

ANSA – Optimization Task

Design Variables → Morphing Parameters

Shape modification

Design Variable = -5.0

Morphing Parameter

Width of depressions

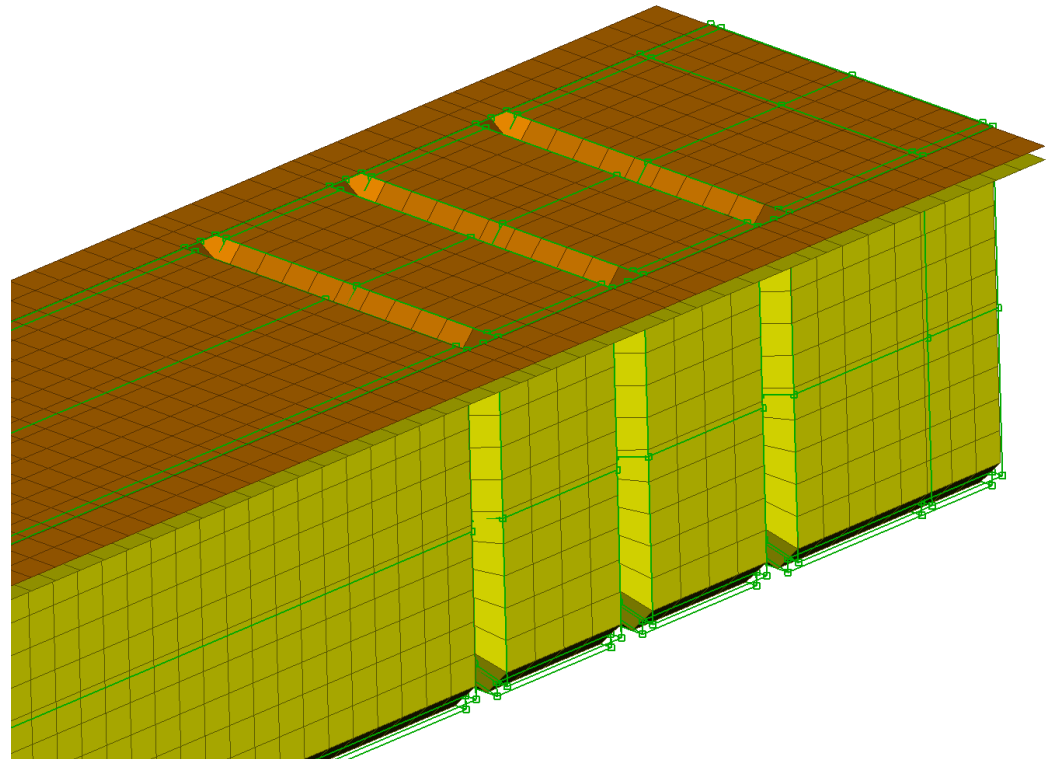

ANSA – Optimization Task

Design Variables → ANSA Parameters

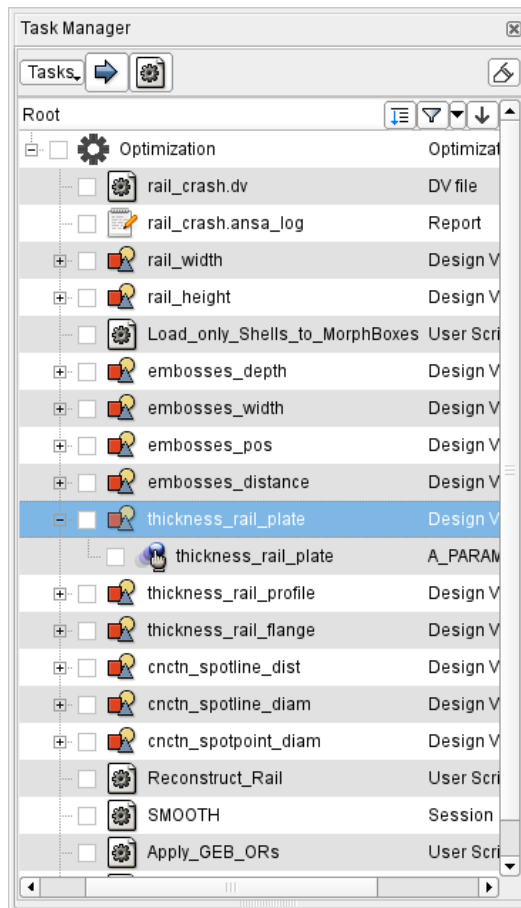

ANSA – Optimization Task

Design Variables → ANSA Parameters

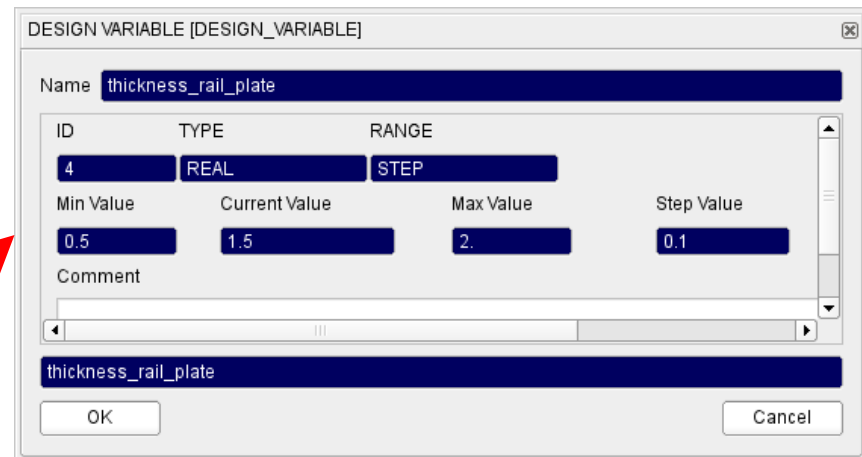
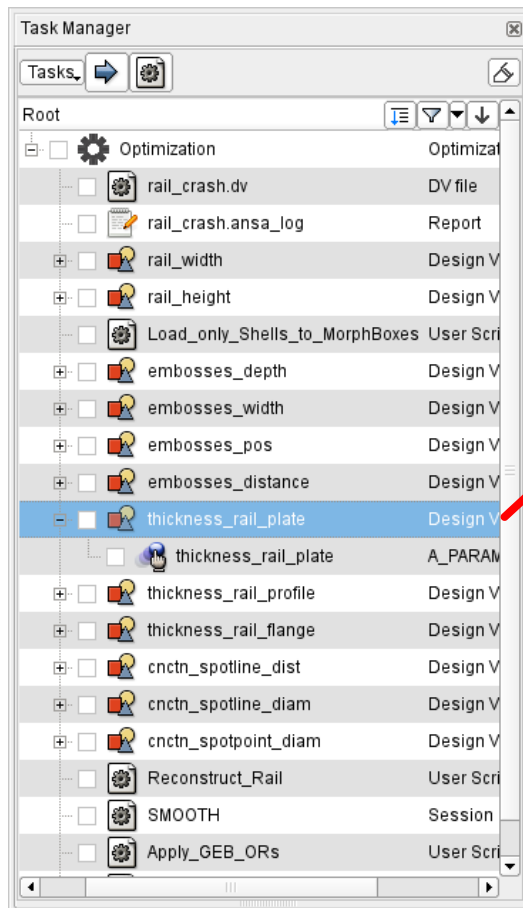

ANSA – Optimization Task

Design Variables → ANSA Parameters

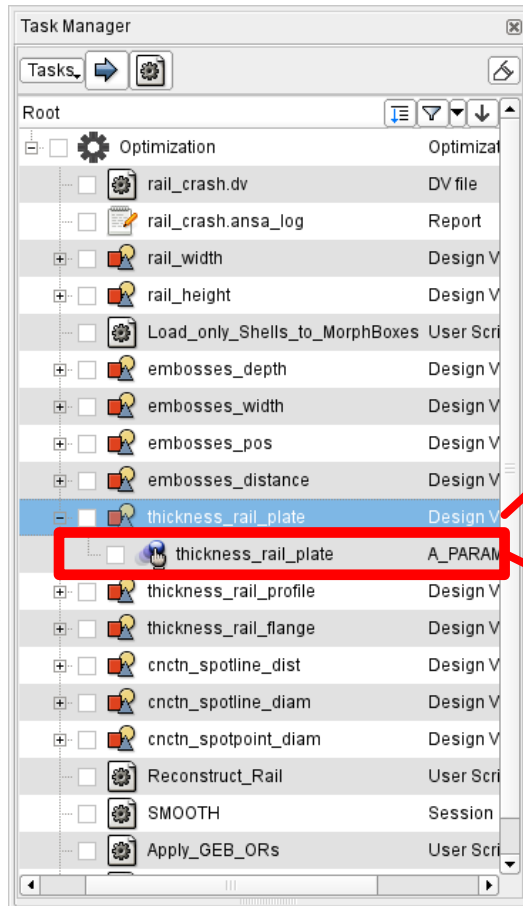

The Task Manager window shows a tree structure under 'Root'. Under 'Optimization', there are several entries including 'rail_crash.dv', 'rail_crash.ansa_log', and various 'Design V' (Design Variables) such as 'rail_width', 'rail_height', 'embosses_depth', 'embosses_width', 'embosses_pos', 'embosses_distance', and 'thickness_rail_plate'. The 'thickness_rail_plate' entry is highlighted with a red box, and a red arrow points from this box to the 'DESIGN VARIABLE' dialog.

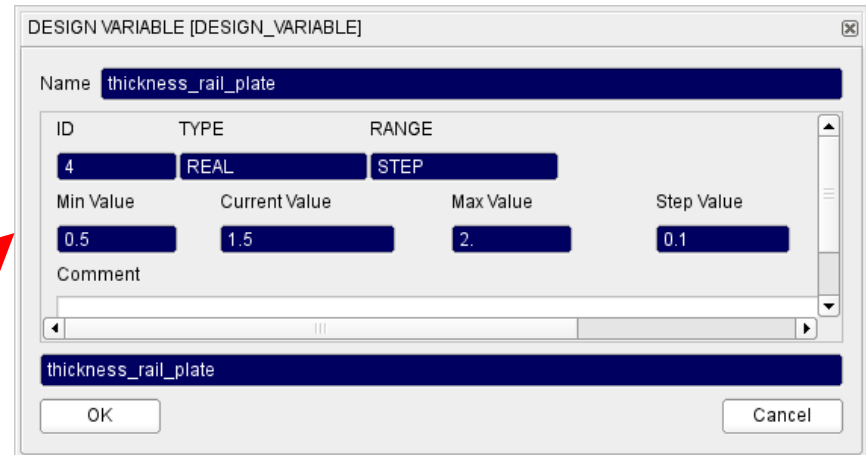

The 'DESIGN VARIABLE [DESIGN_VARIABLE]' dialog box shows the configuration for the design variable 'thickness_rail_plate'. The Name field is 'thickness_rail_plate'. The ID is 4, TYPE is REAL, and RANGE is STEP. The Min Value is 0.5, Current Value is 1.5, Max Value is 2., and Step Value is 0.1. The Comment field is empty. The dialog has OK and Cancel buttons.

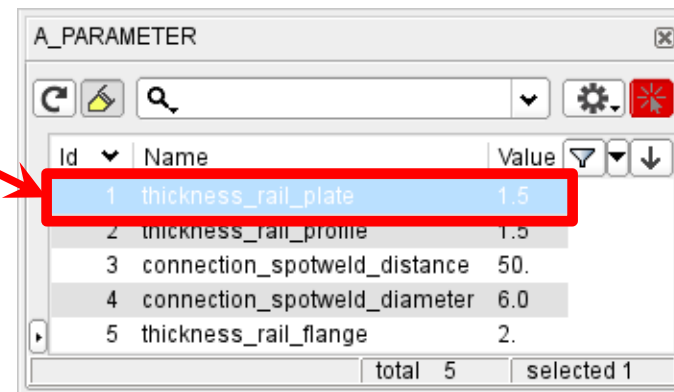

The 'A_PARAMETER' window displays a list of parameters. The first entry is highlighted with a red box:

Id	Name	Value
1	thickness_rail_plate	1.5
2	thickness_rail_profile	1.5
3	connection_spotweld_distance	50.
4	connection_spotweld_diameter	6.0
5	thickness_rail_flange	2.

The status bar at the bottom indicates 'total 5' and 'selected 1'.

ANSA – Optimization Task

Design Variables → ANSA Parameters

Modification of shell thicknesses, materials, etc.

*PART & *SECTION_SHELL [SECTION_SHELL]

Name rail_profile

FROZEN_ID FROZEN_DELETE DEFINED TRIM USE_IN_MODEL

NO NO YES NO YES

PID	SECID	MID	EOSID	HGID	GRAV	ADPOPT	TMID
3		2		3	0	0	
SECID	ELFORM	SHRF	NIP	PROPT	QR/IRID	QR	ICOMP
	16	1	2	1.0	QR	0.0	0
T1	T2	T3	T4	NLOC	MAREA	IDOF	EDGSET
1.5				0		0	

rail_profile

OK ColorEdit Cancel

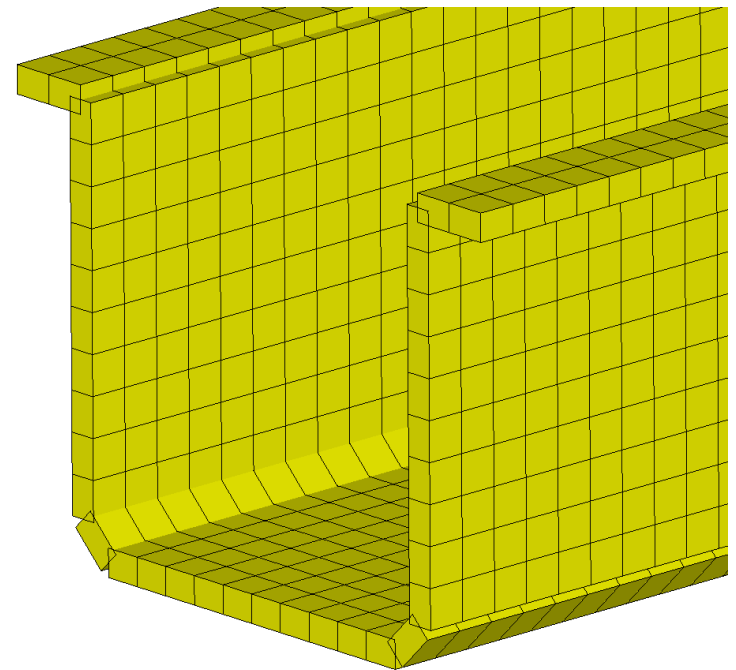

ANSA – Optimization Task

Design Variables → ANSA Parameters

Modification of shell thicknesses, materials, etc.

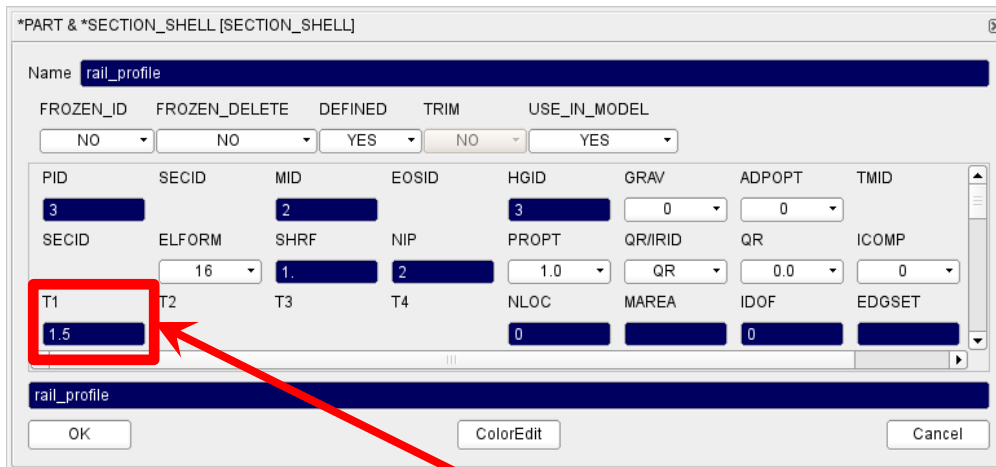

ANSA Parameter

Design Variable = 5.0

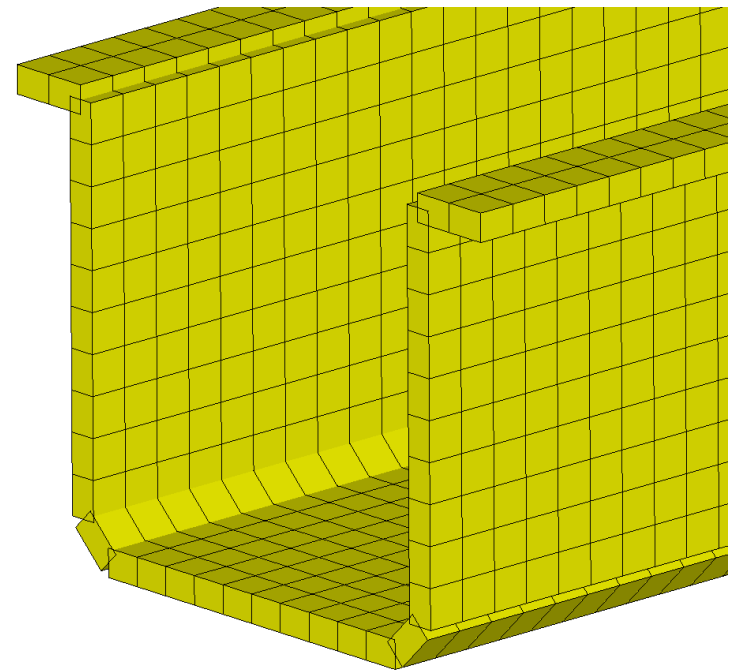

ANSA – Optimization Task

Design Variables → ANSA Parameters

Modification of shell thicknesses, materials, etc.

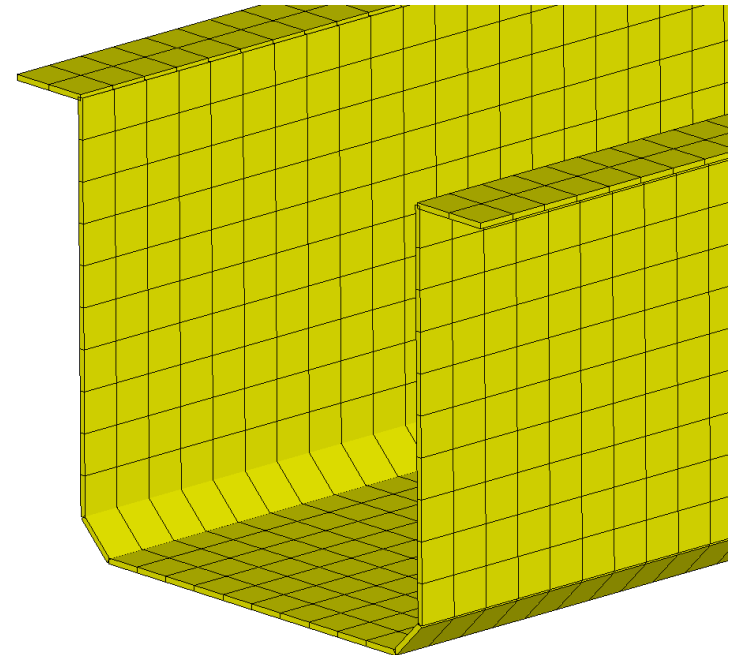
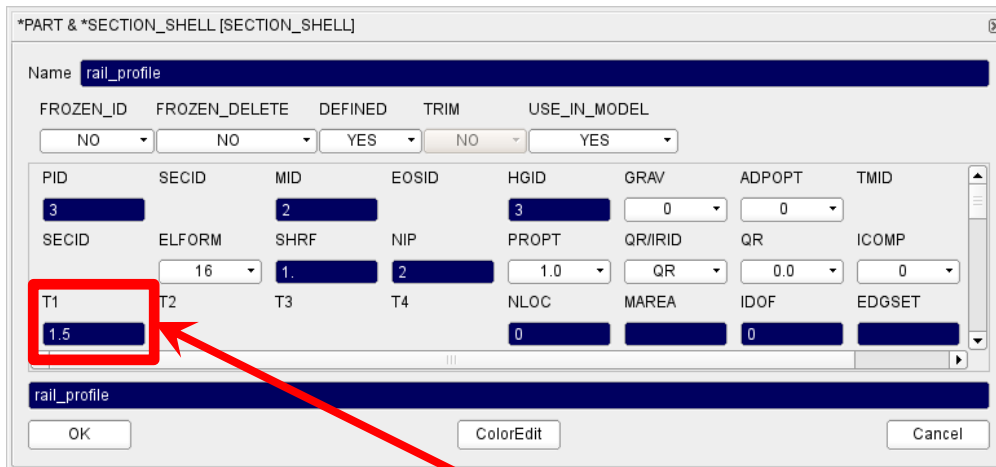

ANSA Parameter

Design Variable = 1.0

ANSA – Optimization Task

Design Variables → ANSA Parameters

Modification of connections (weld spot distance, diameter, etc.)

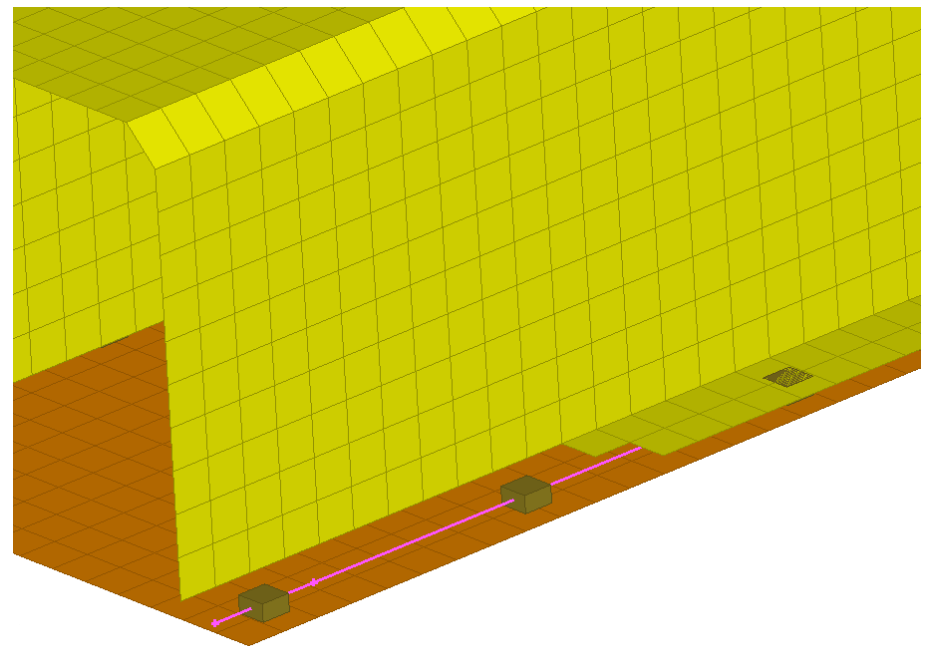
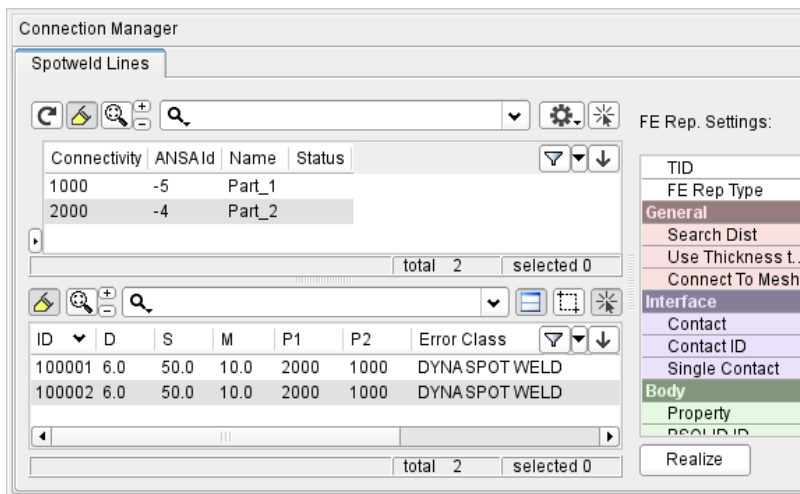

ANSA – Optimization Task

Design Variables → ANSA Parameters

Modification of connections (weld spot distance, diameter, etc.)

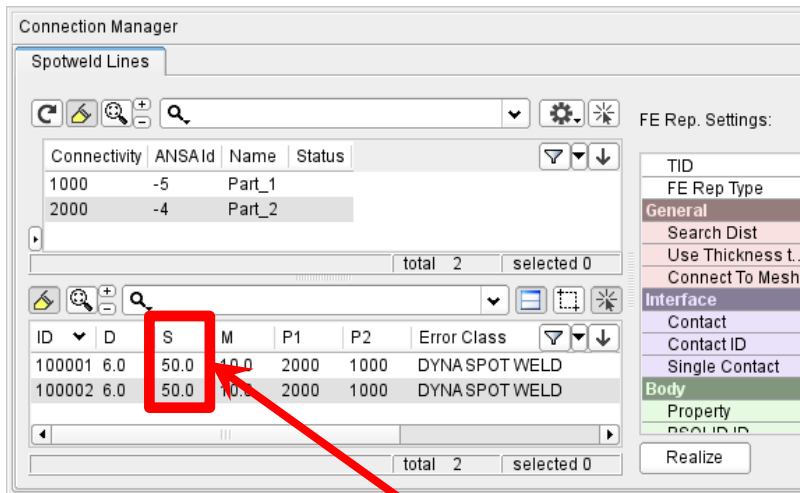

ANSA Parameter

Design Variable (weld spot distance) = 50

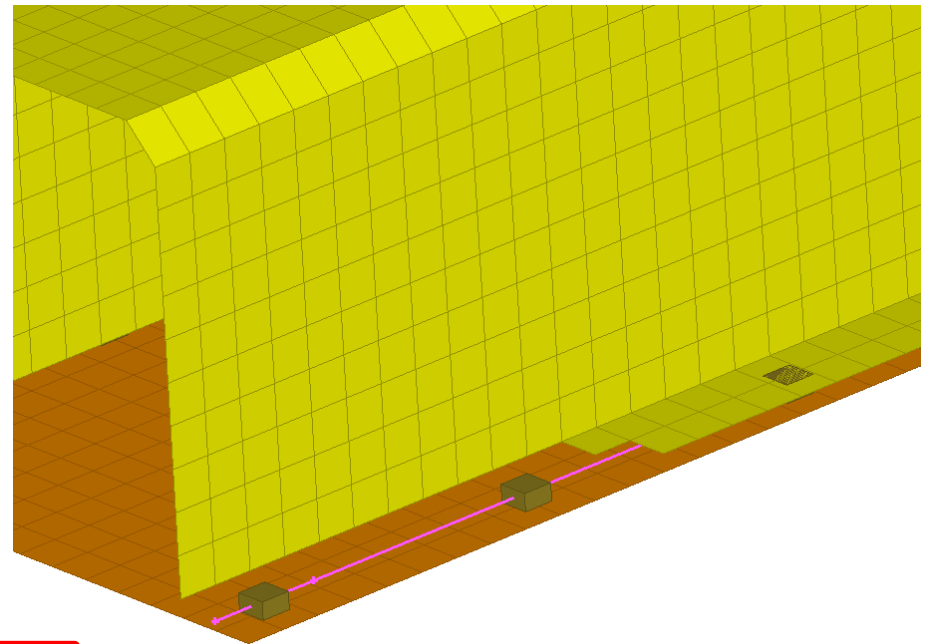

ANSA – Optimization Task

Design Variables → ANSA Parameters

Modification of connections (weld spot distance, diameter, etc.)

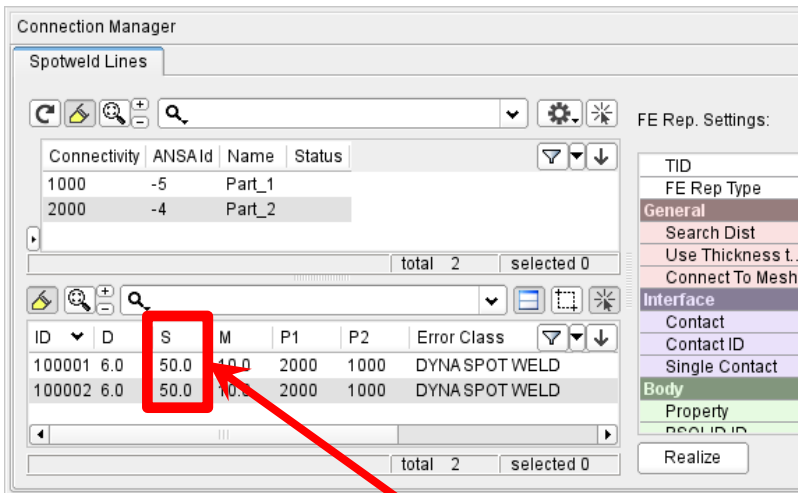

ANSA Parameter

Design Variable (weld spot distance) = 20

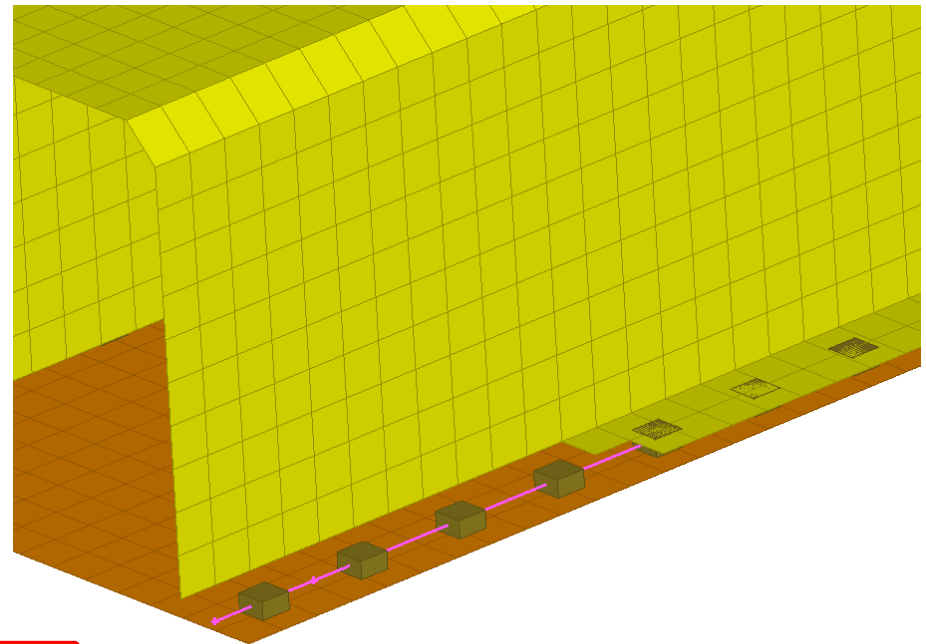

ANSA – Optimization Task

Design Variables → ANSA Parameters

Modification of connections (weld spot distance, diameter, etc.)

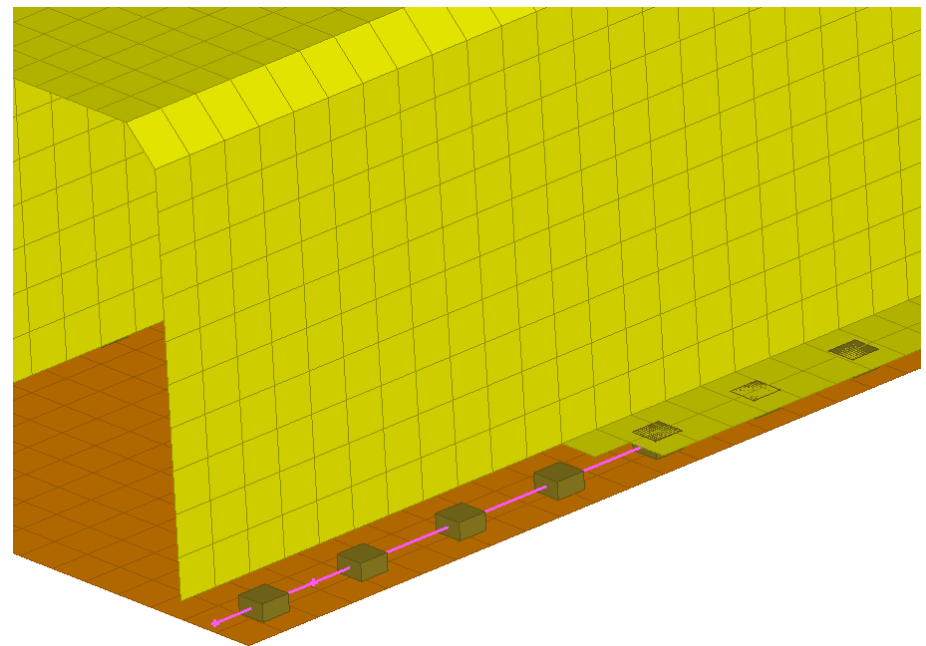
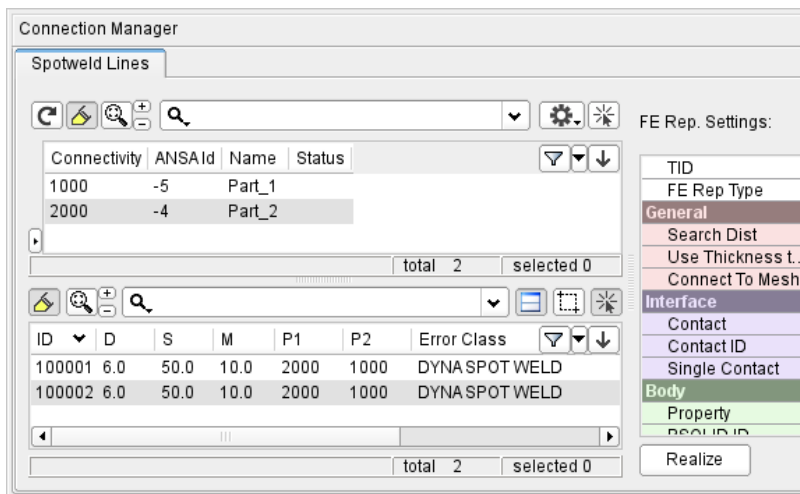

ANSA – Optimization Task

Design Variables → ANSA Parameters

Modification of connections (weld spot distance, diameter, etc.)

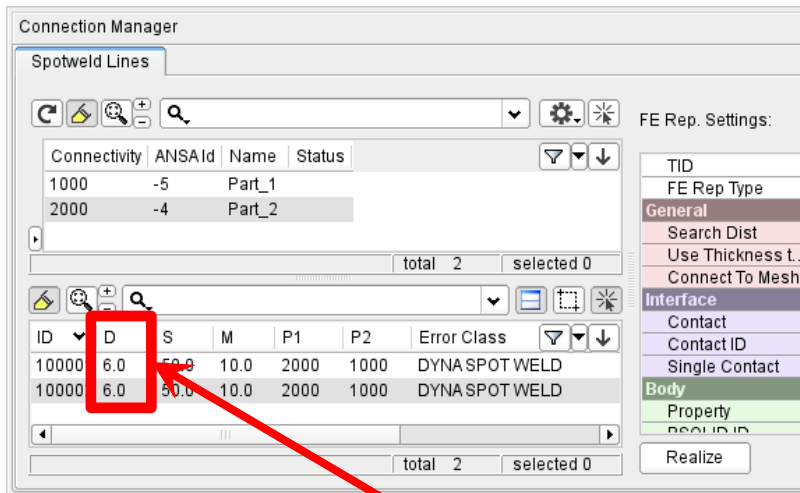

ANSA Parameter

Design Variable (weld spot diameter) = 6.0

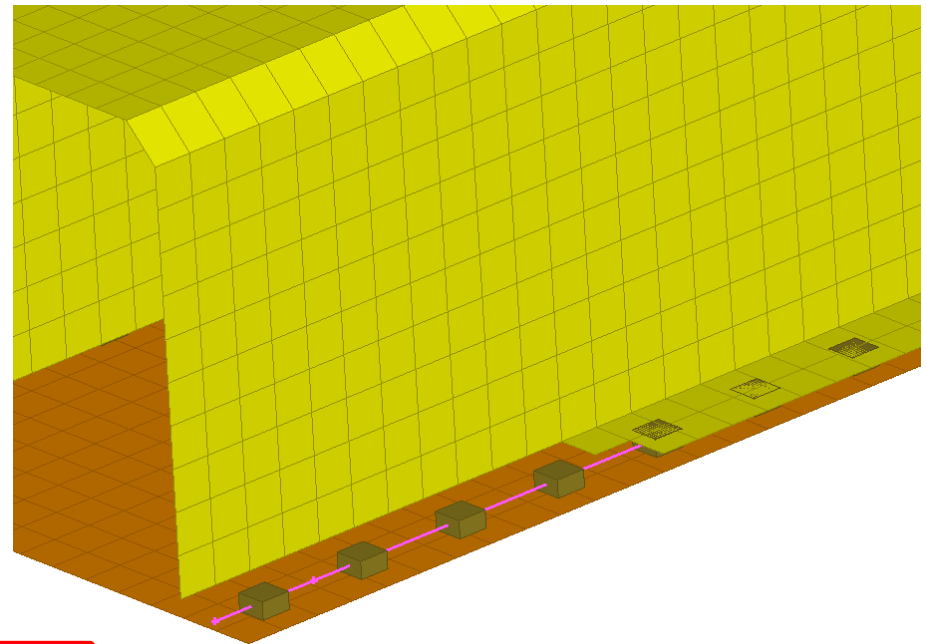

ANSA – Optimization Task

Design Variables → ANSA Parameters

Modification of connections (weld spot distance, diameter, etc.)

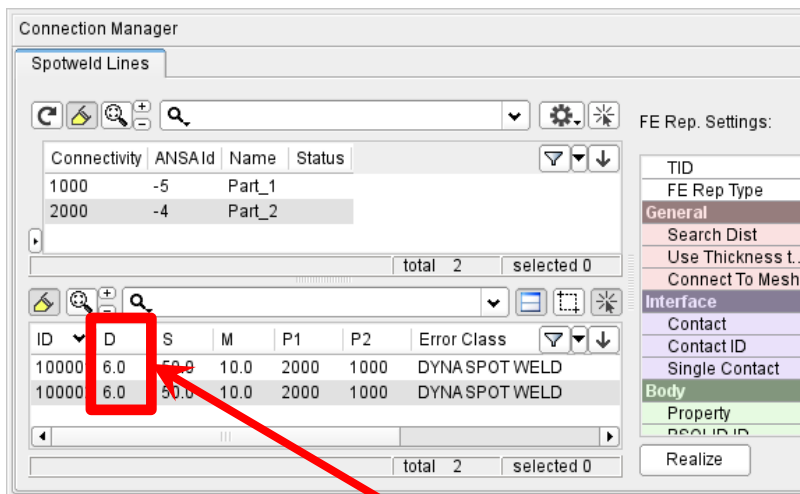

ANSA Parameter

Design Variable (weld spot diameter) = 3.0

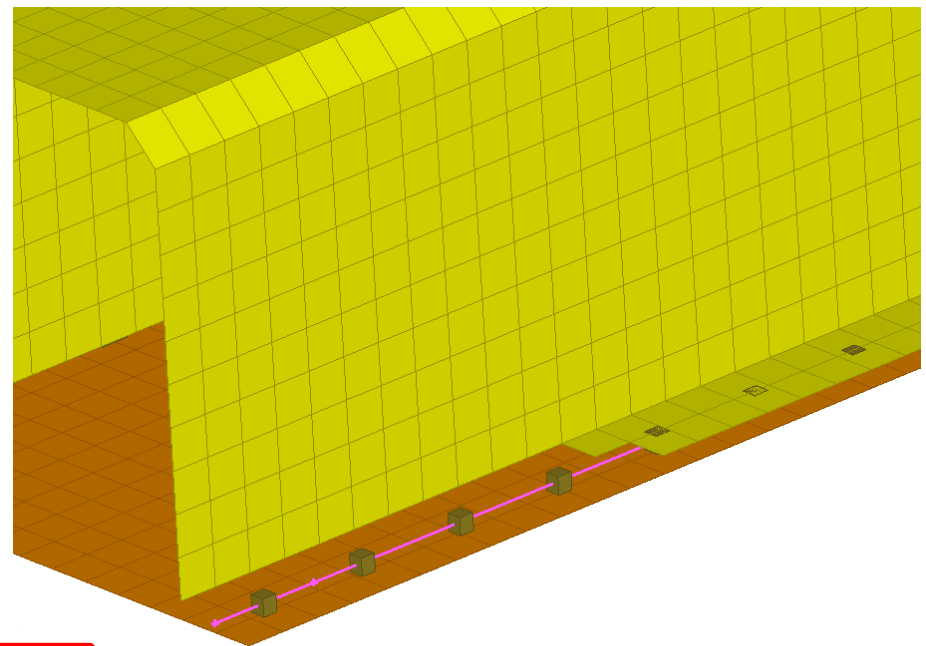

ANSA – Optimization Task

Simulation & DOE

- Checking Combinations of DV (Full Factorial) → Model Validity
- Checking Element Criteria

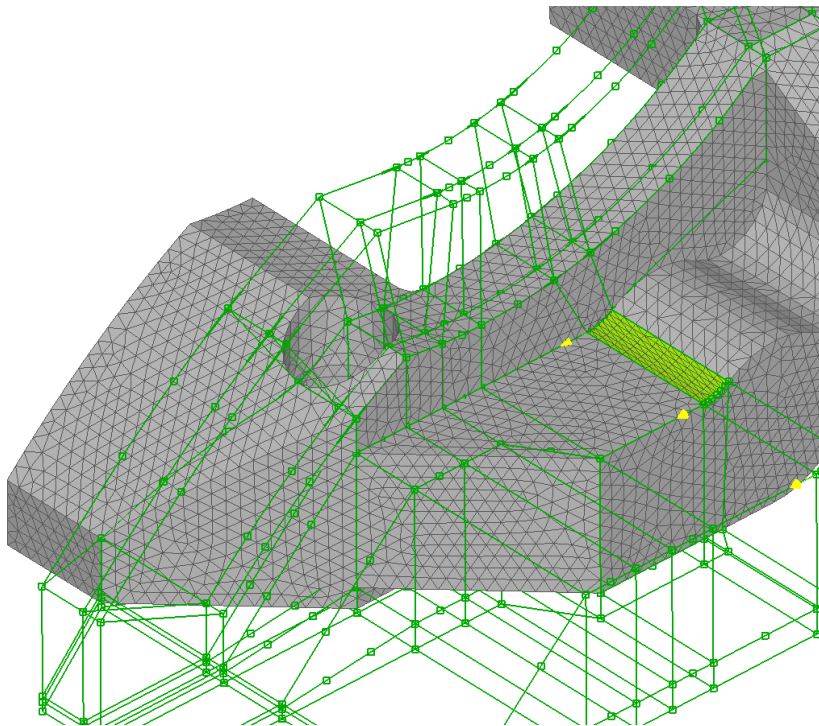

Simulate and DOE

Id	Name	Range	Min	Max
3	DV_Hoehe_Mittelsteg	Bounds	-5.	12.
2	DV_Breite_Seitensteg	Bounds	0.	10.
1	DV_Breite_Flachsteg_oben	Bounds	0.	20.
6	DV_Breite_Flachsteg_unten	Bounds	0.	25.
9	DV_Hoehe_Nase	Bounds	0.	10.
4	DV_Breite_Mittelsteg_ob_au	Bounds	-20.	13.
7	DV_Breite_Mittelsteg_ob_in	Bounds	-20.	13.
5	DV_Breite_Mittelsteg_un_au	Bounds	-13.	10.
8	DV_Breite_Mittelsteg_un_in	Bounds	-13.	10.
10	DV_Breite_Nase	Bounds	0.	20.

	DV_Breit	DV_Brei					
1	0.	0.					
2	2.	5.					
3	4.	10.					
4	6.	15.					
5	8.	20.					
6	10.	25.					

Simulate ▾ Run Task Experiments ▾ Clear table

Algorithm..
Simulate ▾

Generate Steps: 6 ▾

Simulation info

ANSA – Optimization Task

Simulation & DOE

- Checking Combinations of DV (Full Factorial) → Model Validity
- Checking Element Criteria

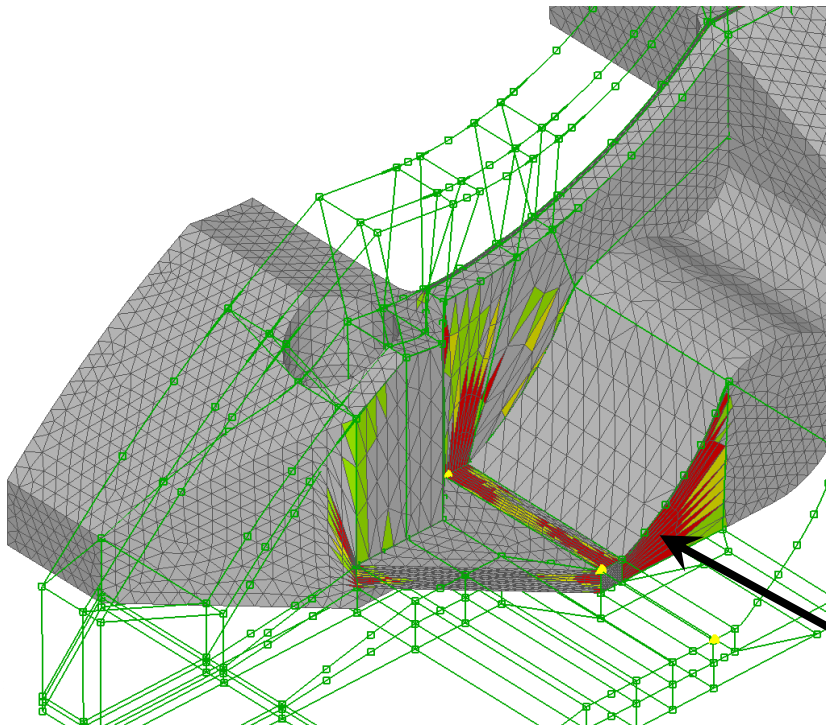

Simulate and DOE

Id	Name	Range	Min	Max
3	DV_Hoehe_Mittelsteg	Bounds	-5.	12.
2	DV_Breite_Seitensteg	Bounds	0.	10.
1	DV_Breite_Flachsteg_oben	Bounds	0.	20.
6	DV_Breite_Flachsteg_unten	Bounds	0.	25.
9	DV_Hoehe_Nase	Bounds	0.	10.
4	DV_Breite_Mittelsteg_oben	Bounds	-20.	13.
7	DV_Breite_Mittelsteg_oben	Bounds	-20.	13.
5	DV_Breite_Mittelsteg_unten	Bounds	-13.	10.
8	DV_Breite_Mittelsteg_unten	Bounds	-13.	10.
10	DV_Breite_Nase	Bounds	0.	20.

	DV_Breit	DV_Brei							
1	0.	0.							
2	2.	5.							
3	4.	10.							
4	6.	15.							
5	8.	20.							
6	10.	25.							

Simulate ▾ Run Task Experiments ▾ Clear table

Algorithm..
Simulate ▾
Generate Steps: 6

Simulation info

Failed elements

ANSA – Optimization Task

Additional commands for improving mesh quality

Fix Quality, Smooth, Reconstruct, etc. for morphed mesh

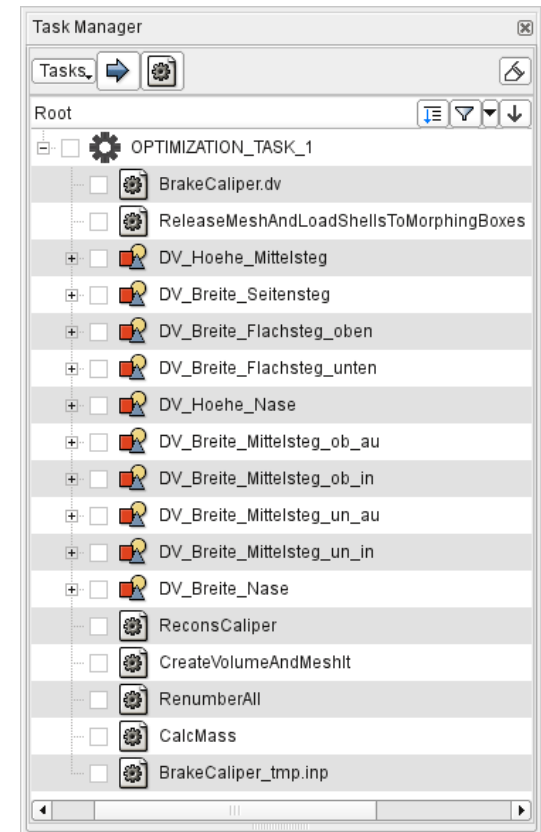
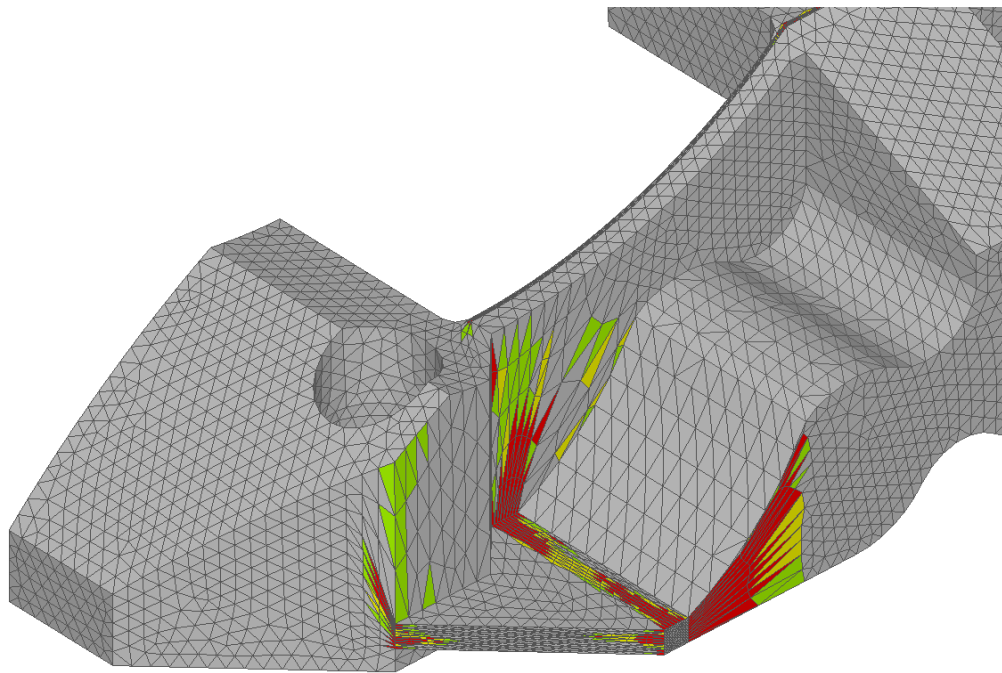

ANSA – Optimization Task

Additional commands for improving mesh quality

Fix Quality, Smooth, Reconstruct, etc. for morphed mesh

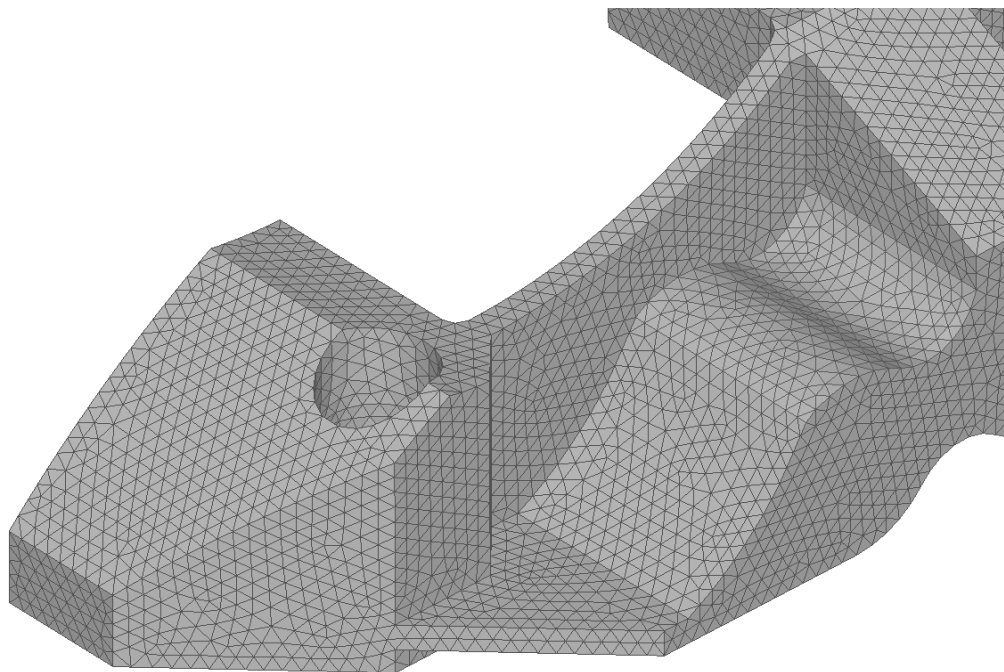

μETA – OptimizerSetup Toolbar

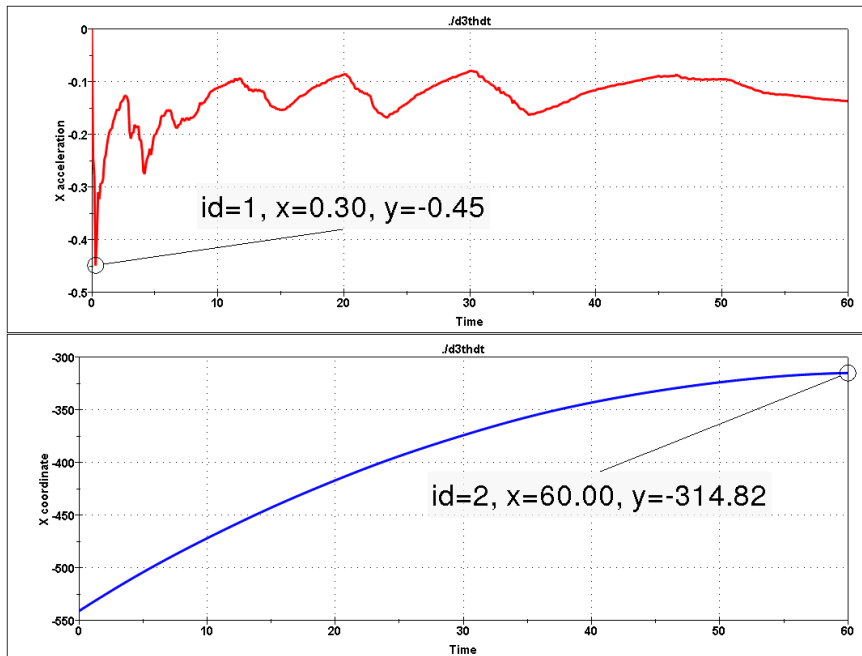

The screenshot shows the 'OptimizerSetup' window with the following sections:

- Response Variables**
 - Responses: 1 acceleration
 - Buttons: Add, Print Response Values, Update Response Values (Current, All), Remove (Current, All), Rename Response
- History Variables**
 - Histories: (empty)
 - Buttons: Add, Print History Values, Update History Values (Current, All), Remove (Current, All), Rename History
- Export Session** button

μ ETA – OptimizerSetup Toolbar

- Responses from annotations, variables, advanced expressions

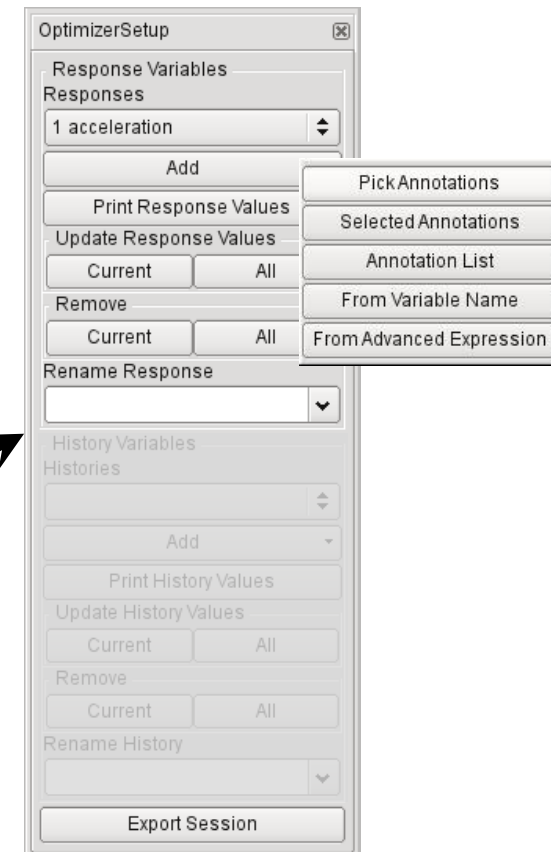
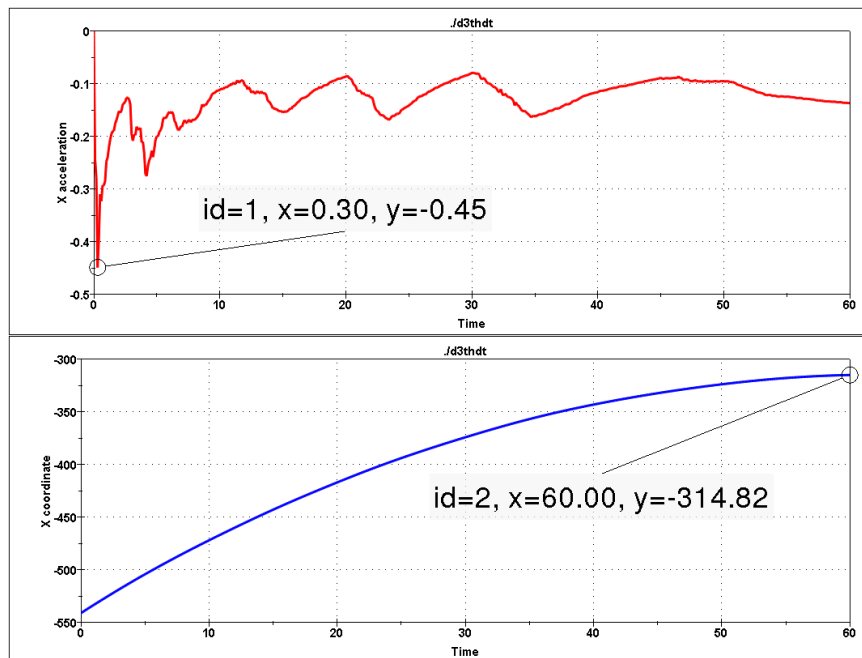

μ ETA – OptimizerSetup Toolbar

- Responses from annotations, variables, advanced expressions
- Histories from 2D plot curves

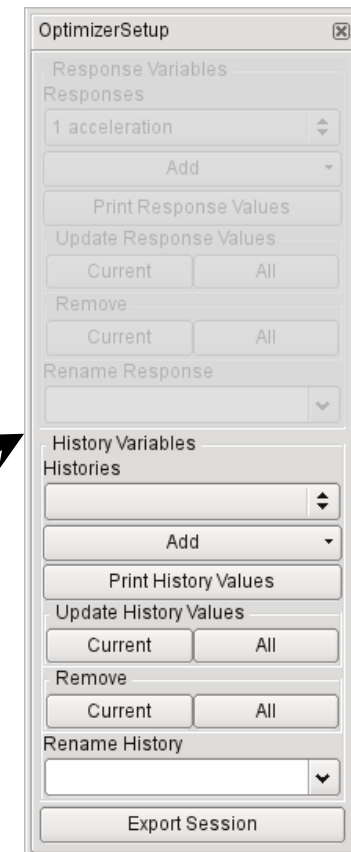
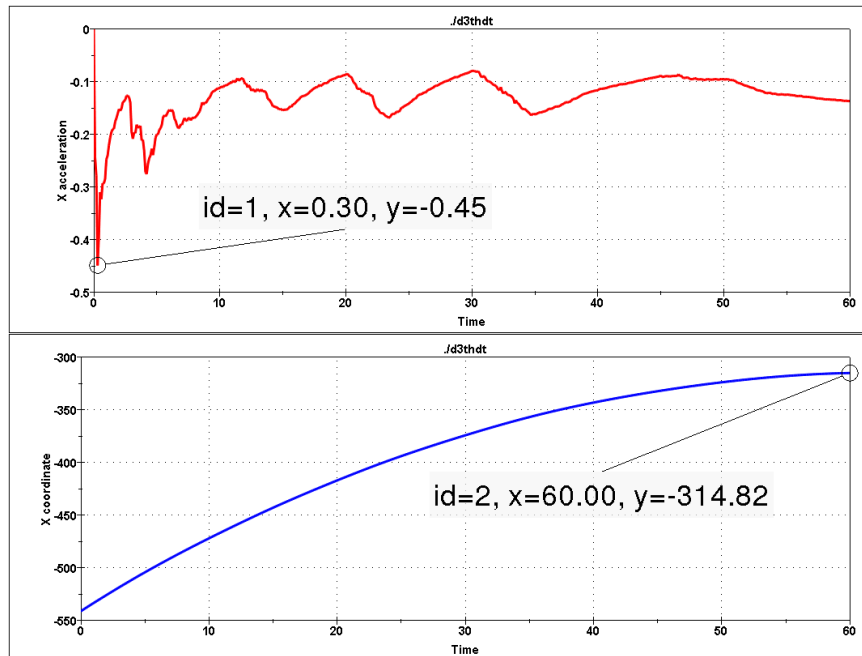

μ ETA – OptimizerSetup Toolbar

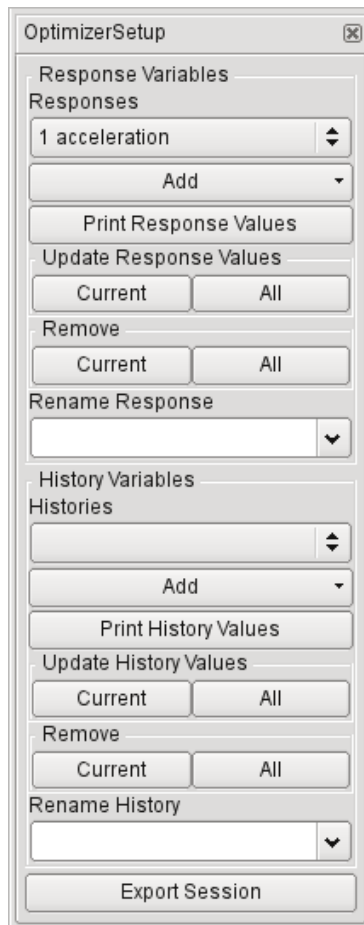

μETA – OptimizerSetup Toolbar

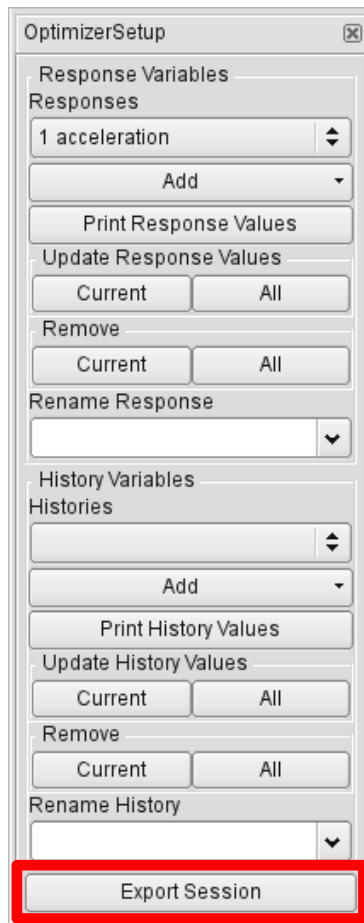

Exports:

- Session file (for reproduction of results extraction)
- Output file, containing responses and histories

```
#OptimizerSetup Response & history File created by META post  
RESPONSES  
1, acceleration, -1.18  
2, intrusion, -440.07  
END
```

Correctly formatted for
import in LS-OPT

Connecting **ANSA** to LS-OPT

Connecting ANSA to LS-OPT

Stage for ANSA

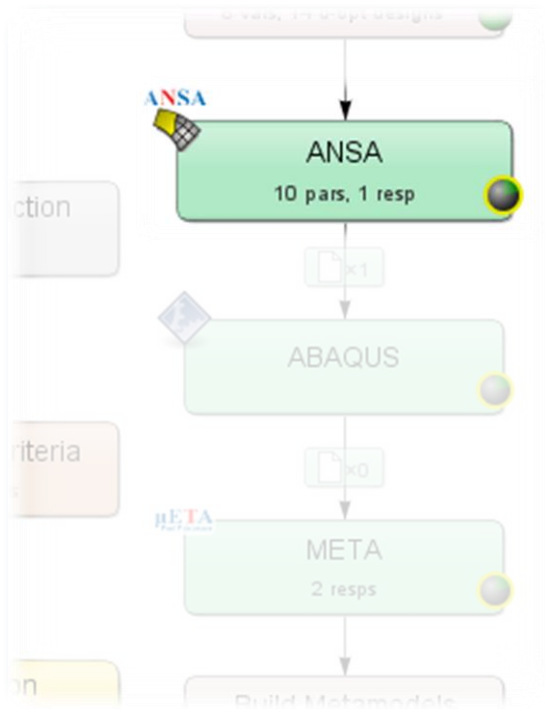

Connecting ANSA to LS-OPT

Stage for ANSA

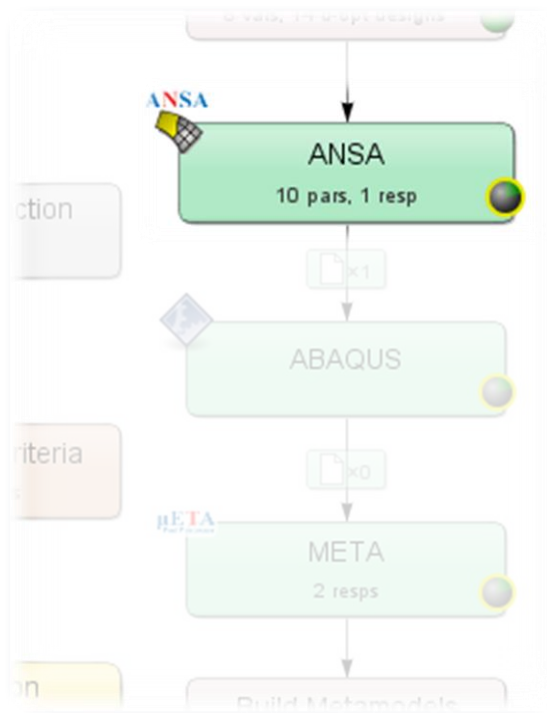
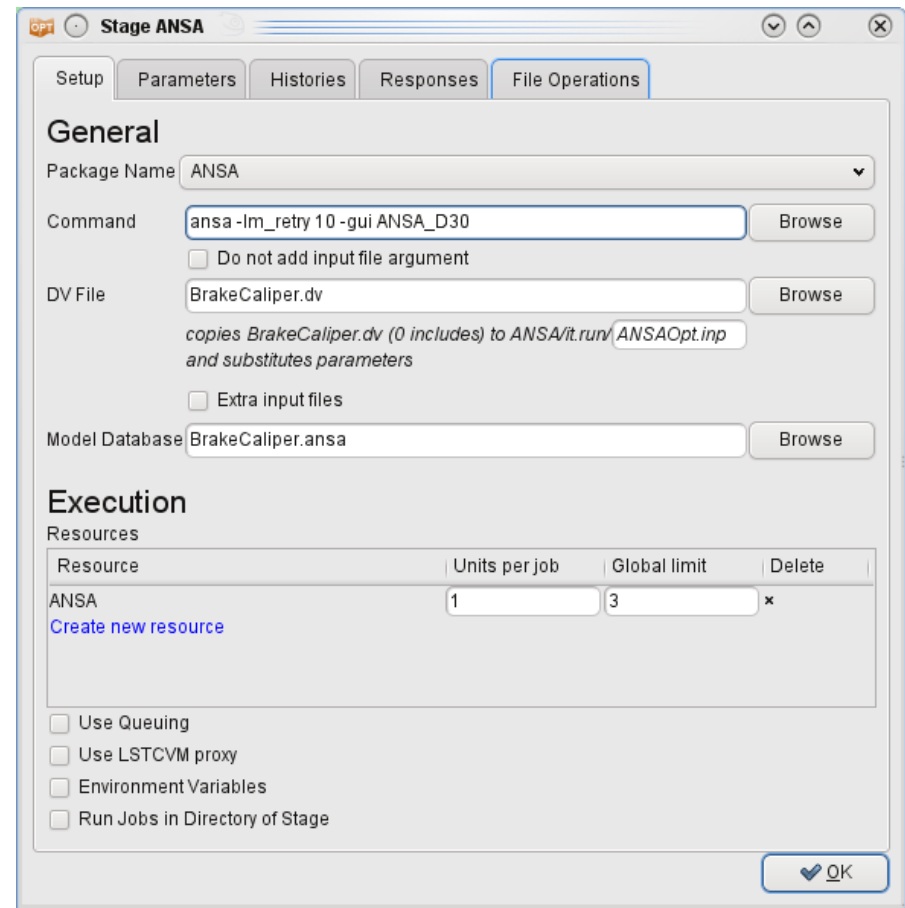
The screenshot shows the 'Stage ANSA' configuration window in LS-OPT. The window is divided into several tabs: Setup, Parameters, Histories, Responses, and File Operations. The 'General' section is currently active, showing the following configuration:

- Package Name: ANSA
- Command: `ansa -lm_retry 10 -gui ANSA_D30`
- Do not add input file argument:
- DV File: `BrakeCaliper.dv`
- copies `BrakeCaliper.dv` (0 includes) to `ANSA/it.run/ANSAOpt.inp` and substitutes parameters:
- Extra input files:
- Model Database: `BrakeCaliper.ansa`

The 'Execution' section shows the resource configuration:

Resource	Units per job	Global limit	Delete
ANSA	1	3	x

Below the table, there is a link to 'Create new resource'. At the bottom of the window, there are several checkboxes for execution options:

- Use Queuing
- Use LSTCVM proxy
- Environment Variables
- Run Jobs in Directory of Stage

The window concludes with an 'OK' button.

Connecting ANSA to LS-OPT

Stage for ANSA

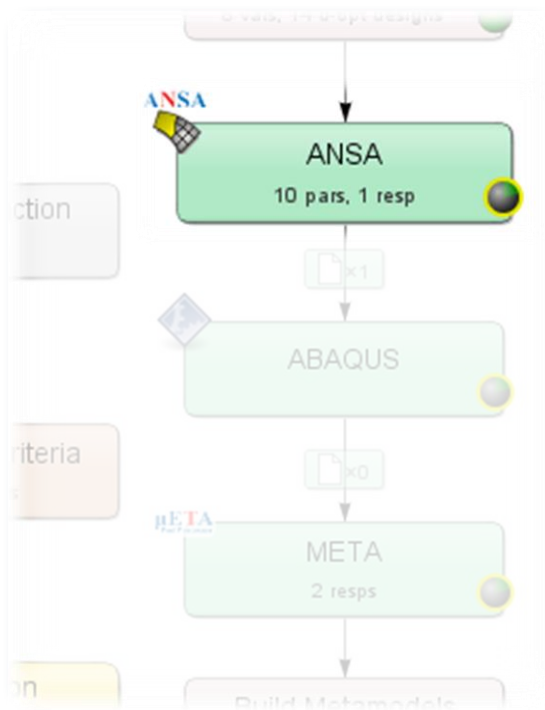

Stage ANSA

Setup Parameters Histories Responses File Operations

General

Package Name ANSA

Command `ansa -lm_retry 10 -gui ANSA_D30` Browse

Do not add input file argument

DV File `BrakeCaliper.dv` Browse

copies BrakeCaliper.dv (0 includes) to ANSA/it.ruv/ ANSAOpt.inp and substitutes parameters

Extra input files

Model Database `BrakeCaliper.ansa` Browse

Execution

Resources

Resource	Units per job	Global limit	Delete
ANSA	1	3	x

[Create new resource](#)

Use Queuing

Use LSTCVM proxy

Environment Variables

Run Jobs in Directory of Stage

OK

Connecting ANSA to LS-OPT

ANSA → DV file → Design Variables in LS-OPT

```
#
# ANSA_VERSION: 15.0.1
#
# file created by ANSA Fri Feb 14 15:49:00 2014
#
# Output from:
# ansaout.ansa
#
# DESIGN VARIABLES
#-----
# ID | DESIGN VARIABLE NAME | TYPE | RANGE | CURRENT VA
#-----
3, DV_Hoehe_Mittelsteg, REAL, BOUNDS, 0., -5.
2, DV_Breite_Seitensteg, REAL, BOUNDS, 0., -5.
1, DV_Breite_Flachsteg_oben, REAL, BOUNDS, 0., 15.
6, DV_Breite_Flachsteg_unten, REAL, BOUNDS, 0., 25.
9, DV_Hoehe_Nase, REAL, BOUNDS, 0., 0., 10.
4, DV_Breite_Mittelsteg_ob_au, REAL, BOUNDS, 0., 13.
7, DV_Breite_Mittelsteg_ob_in, REAL, BOUNDS, 10, -20, 13.
Continuous, DV_Breite_Mittelsteg_un_au, 0, 0, 10
Continuous, DV_Breite_Mittelsteg_un_in, 5, -13, 10
Continuous, DV_Breite_Nase, 0, 0, 20
Continuous, DV_Breite_Seitensteg, 0, -5, 10
Continuous, DV_Hoehe_Mittelsteg, 0, -5, 12
Continuous, DV_Hoehe_Nase, 0, 0, 10
#-----
```

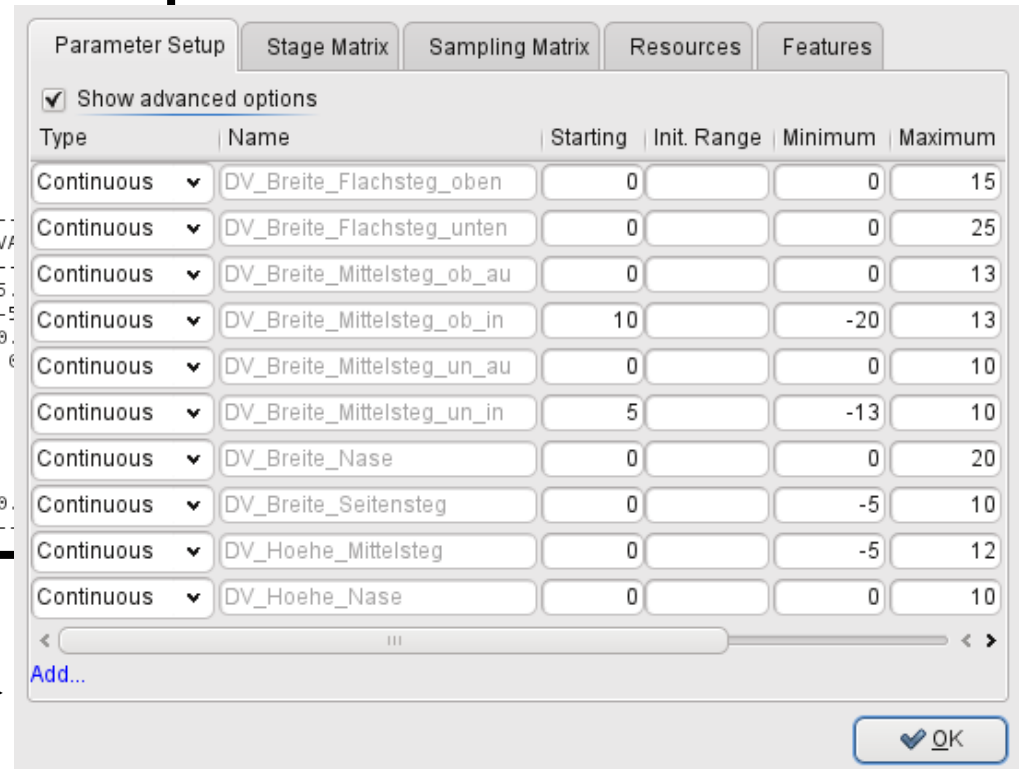

Type	Name	Starting	Init. Range	Minimum	Maximum
Continuous	DV_Breite_Flachsteg_oben	0		0	15
Continuous	DV_Breite_Flachsteg_unten	0		0	25
Continuous	DV_Breite_Mittelsteg_ob_au	0		0	13
Continuous	DV_Breite_Mittelsteg_ob_in	10		-20	13
Continuous	DV_Breite_Mittelsteg_un_au	0		0	10
Continuous	DV_Breite_Mittelsteg_un_in	5		-13	10
Continuous	DV_Breite_Nase	0		0	20
Continuous	DV_Breite_Seitensteg	0		-5	10
Continuous	DV_Hoehe_Mittelsteg	0		-5	12
Continuous	DV_Hoehe_Nase	0		0	10

Connecting ANSA to LS-OPT

Fine Tuning of Design Variables, e.g.

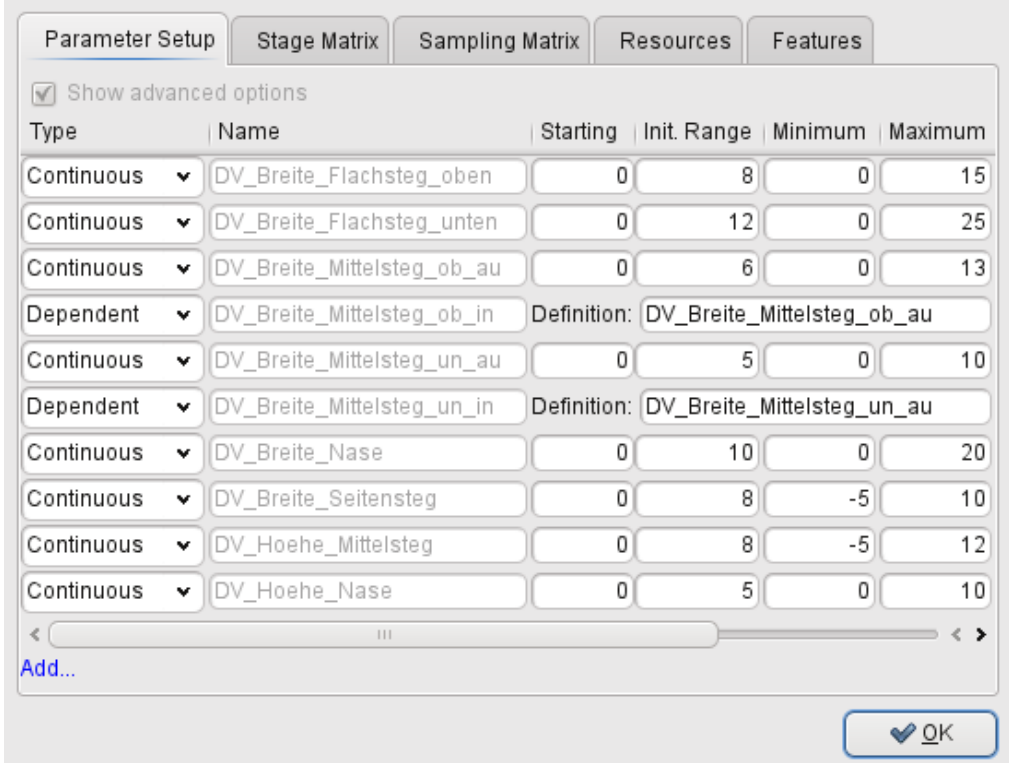

The screenshot shows the 'Parameter Setup' dialog box in LS-OPT. It has tabs for 'Parameter Setup', 'Stage Matrix', 'Sampling Matrix', 'Resources', and 'Features'. The 'Parameter Setup' tab is active, and the 'Show advanced options' checkbox is checked. Below this is a table of design variables with columns for Type, Name, Starting, Init. Range, Minimum, and Maximum. There are also 'Definition' fields for dependent variables. At the bottom, there is an 'Add...' button and an 'OK' button.

Type	Name	Starting	Init. Range	Minimum	Maximum
Continuous	DV_Breite_Flachsteg_oben	0	8	0	15
Continuous	DV_Breite_Flachsteg_unten	0	12	0	25
Continuous	DV_Breite_Mittelsteg_ob_au	0	6	0	13
Dependent	DV_Breite_Mittelsteg_ob_in	Definition: DV_Breite_Mittelsteg_ob_au			
Continuous	DV_Breite_Mittelsteg_un_au	0	5	0	10
Dependent	DV_Breite_Mittelsteg_un_in	Definition: DV_Breite_Mittelsteg_un_au			
Continuous	DV_Breite_Nase	0	10	0	20
Continuous	DV_Breite_Seitensteg	0	8	-5	10
Continuous	DV_Hoehe_Mittelsteg	0	8	-5	12
Continuous	DV_Hoehe_Nase	0	5	0	10

Connecting ANSA to LS-OPT

Fine Tuning of Design Variables, e.g.

- Ranges

The screenshot shows the 'Parameter Setup' dialog box in ANSA. The 'Show advanced options' checkbox is checked. The dialog displays a table of design variables with their types, names, starting values, initial ranges, and minimum/maximum values. Several initial range values are highlighted with red boxes.

Type	Name	Starting	Init. Range	Minimum	Maximum
Continuous	DV_Breite_Flachsteg_oben	0	8	0	15
Continuous	DV_Breite_Flachsteg_unten	0	12	0	25
Continuous	DV_Breite_Mittelsteg_ob_au	0	6	0	13
Dependent	DV_Breite_Mittelsteg_ob_in	Definition: DV_Breite_Mittelsteg_ob_au			
Continuous	DV_Breite_Mittelsteg_un_au	0	5	0	10
Dependent	DV_Breite_Mittelsteg_un_in	Definition: DV_Breite_Mittelsteg_un_au			
Continuous	DV_Breite_Nase	0	10	0	20
Continuous	DV_Breite_Seitensteg	0	8	-5	10
Continuous	DV_Hoehe_Mittelsteg	0	8	-5	12
Continuous	DV_Hoehe_Nase	0	5	0	10

Buttons: Add..., OK

Connecting ANSA to LS-OPT

Fine Tuning of Design Variables, e.g.

- Ranges
- Dependencies
- etc.

The screenshot shows the 'Parameter Setup' dialog box in ANSA. It has tabs for 'Parameter Setup', 'Stage Matrix', 'Sampling Matrix', 'Resources', and 'Features'. The 'Parameter Setup' tab is active, and 'Show advanced options' is checked. A table lists design variables with their types, names, starting values, initial ranges, and minimum/maximum values. Two rows are highlighted with red boxes: 'DV_Breite_Mittelsteg_ob_in' (Dependent, Definition: DV_Breite_Mittelsteg_ob_au) and 'DV_Breite_Mittelsteg_un_in' (Dependent, Definition: DV_Breite_Mittelsteg_un_au). The 'Add...' button is visible at the bottom left, and the 'OK' button is at the bottom right.

Type	Name	Starting	Init. Range	Minimum	Maximum
Continuous	DV_Breite_Flachsteg_oben	0	8	0	15
Continuous	DV_Breite_Flachsteg_unten	0	12	0	25
Continuous	DV_Breite_Mittelsteg_ob_au	0	6	0	13
Dependent	DV_Breite_Mittelsteg_ob_in	Definition: DV_Breite_Mittelsteg_ob_au			
Continuous	DV_Breite_Mittelsteg_un_au	0	5	0	10
Dependent	DV_Breite_Mittelsteg_un_in	Definition: DV_Breite_Mittelsteg_un_au			
Continuous	DV_Breite_Nase	0	10	0	20
Continuous	DV_Breite_Seitensteg	0	8	-5	10
Continuous	DV_Hoehe_Mittelsteg	0	8	-5	12
Continuous	DV_Hoehe_Nase	0	5	0	10

Connecting μ ETA to LS-OPT

Connecting μ ETA to LS-OPT

Stage for μ ETA

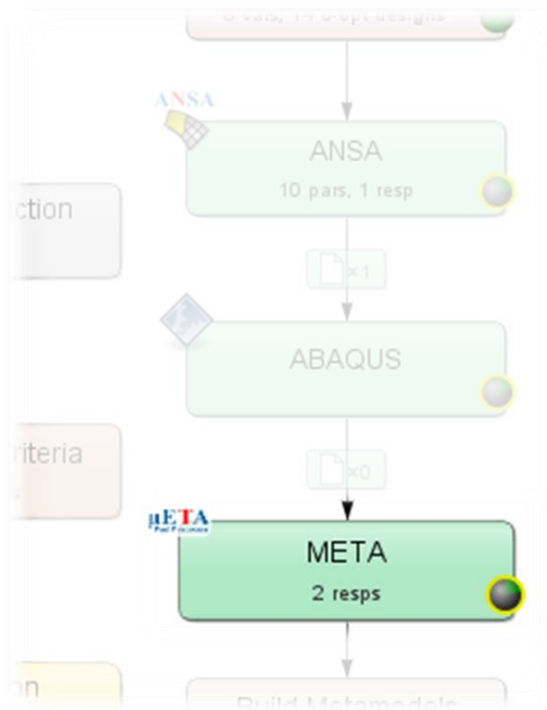

Connecting μ ETA to LS-OPT

Stage for μ ETA

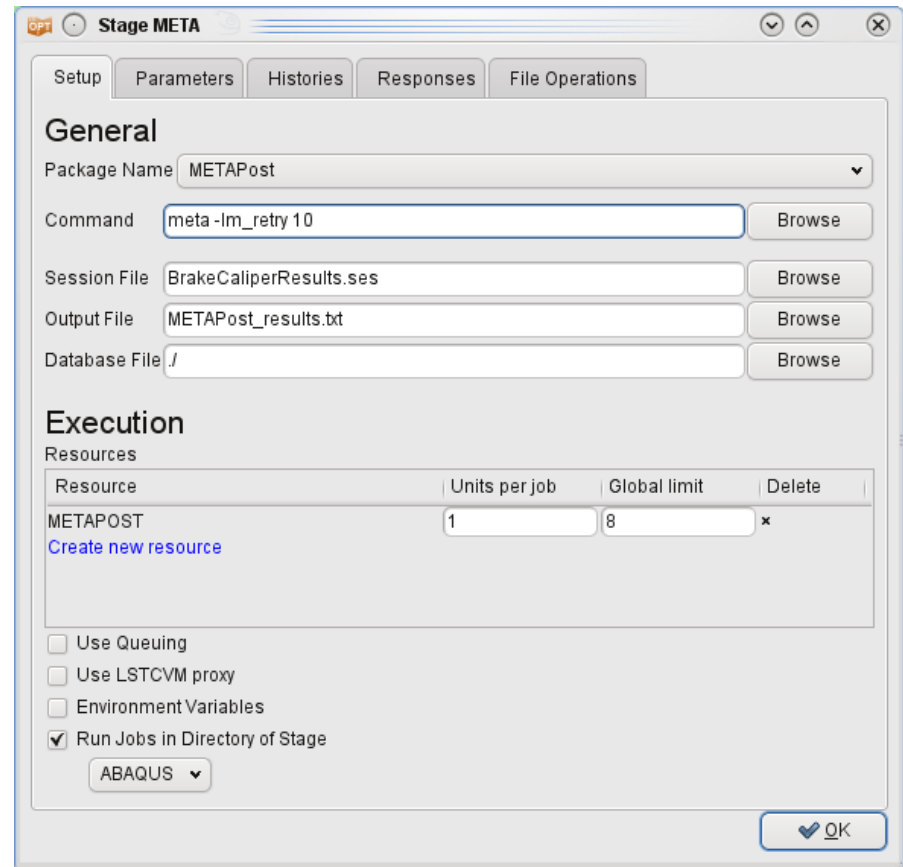
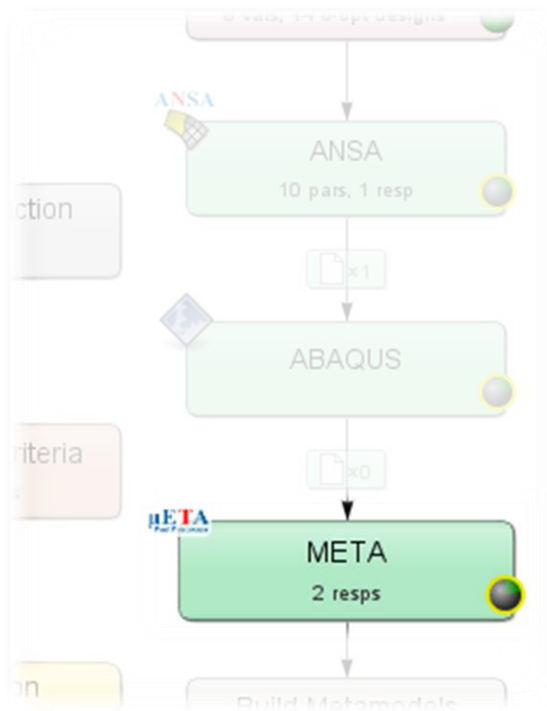

Connecting μ ETA to LS-OPT

Stage for μ ETA

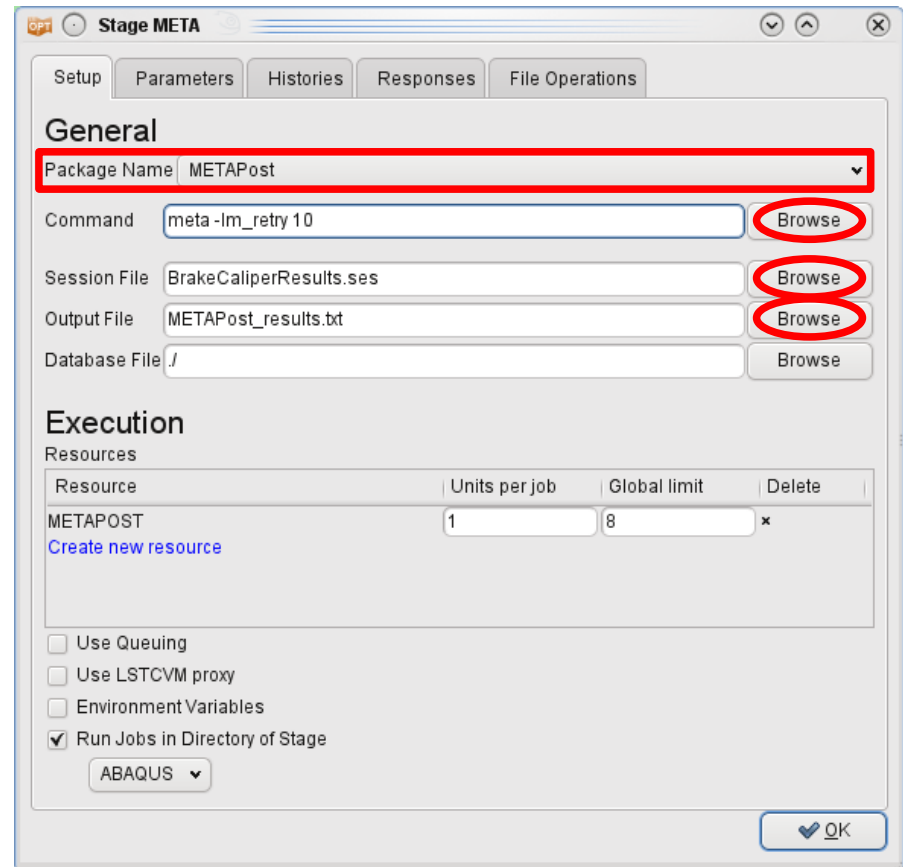
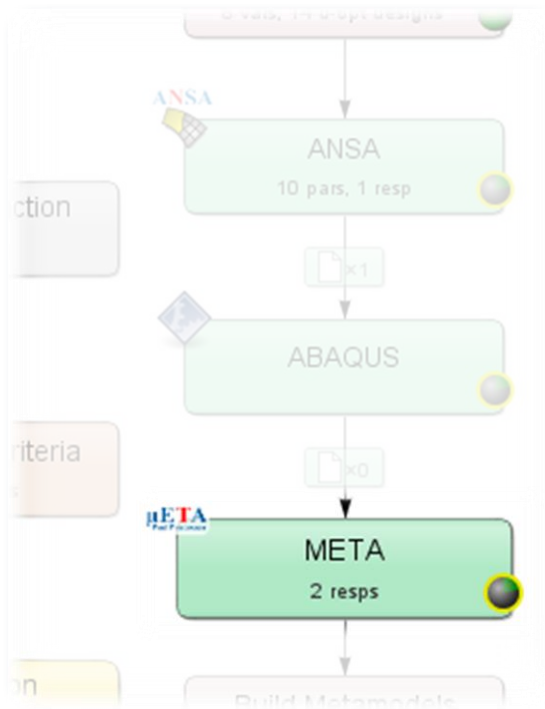

Connecting μ ETA to LS-OPT

μ ETA → Output file → Responses and Histories in LS-OPT

```
#OptimizerSetup Response & history File created by META post  
RESPONSES  
1,nodes_rel_disp,0.174171448  
2,max_stress,169.780731  
END
```

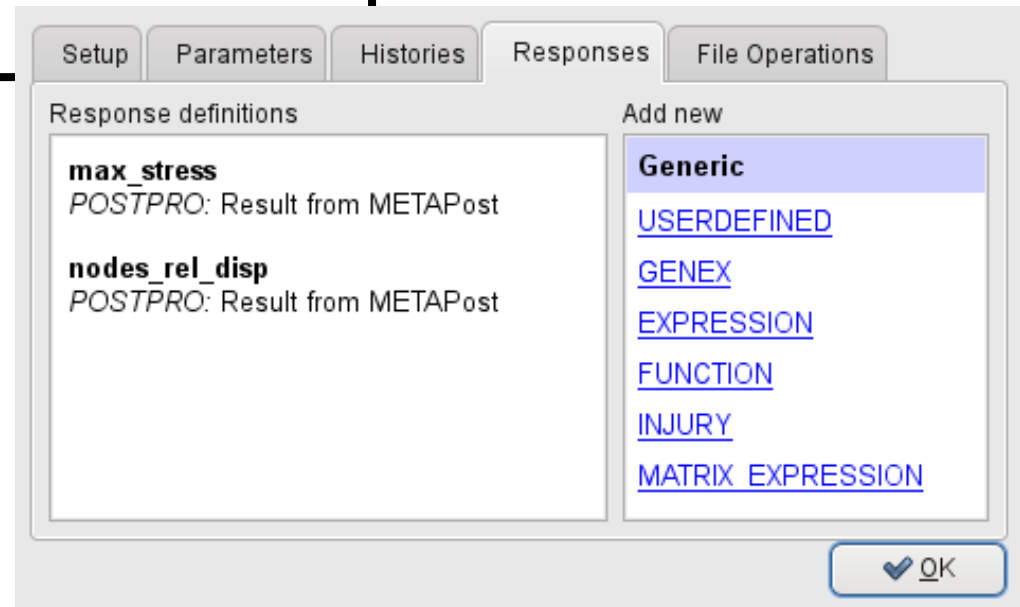

Optimization Run

LS-OPT → ANSA → Solver → META → LS-OPT

LS-OPT determines set of DV and outputs DV file

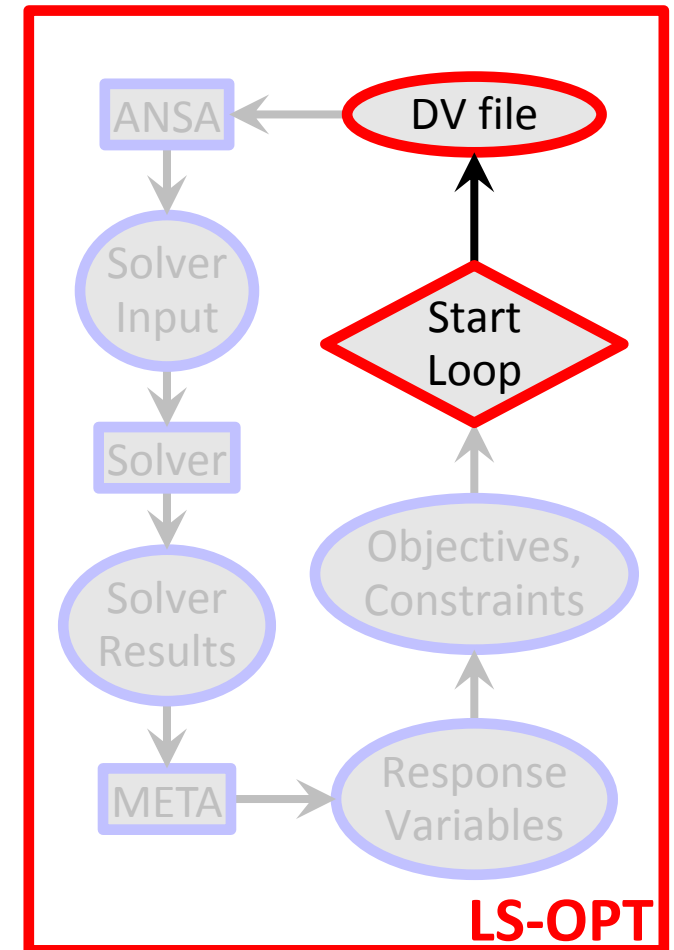

Optimization Run

LS-OPT → ANSA → Solver → META → LS-OPT

LS-OPT determines set of DV and outputs DV file

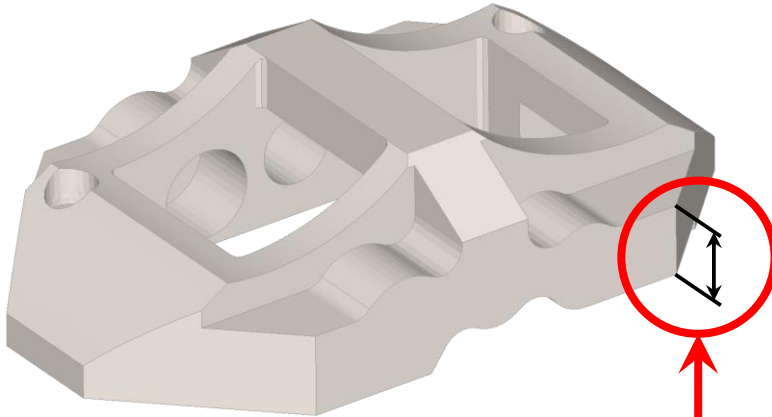

#	ID	DESIGN VARIABLE NAME	TYPE	RANGE	CURRENT VALUE	MIN VALUE
3,	DV_Hoehne_Mittelsteg,	REAL,	BOUNDS,	0., -5., 12.		
2,	DV_Breite_Seitensteg,	REAL,	BOUNDS,	0., -5., 10.		
1,	DV_Breite_Flachsteg_oben,	REAL,	BOUNDS,	0., 0., 20.		
6,	DV_Breite_Flachsteg_unten,	REAL,	BOUNDS,	0., 0., 25.		
9,	DV_Hoehne_Nase,	REAL,	BOUNDS,	0., 0., 10.		
4,	DV_Breite_Mittelsteg_ob_au,	REAL,	BOUNDS,	0., -20., 13.		
7,	DV_Breite_Mittelsteg_ob_in,	REAL,	BOUNDS,	0., -20., 13.		
5,	DV_Breite_Mittelsteg_un_au,	REAL,	BOUNDS,	0., -13., 10.		
8,	DV_Breite_Mittelsteg_un_in,	REAL,	BOUNDS,	0., -13., 10.		
10,	DV_Breite_Nase,	REAL,	BOUNDS,	0., 0., 20.		

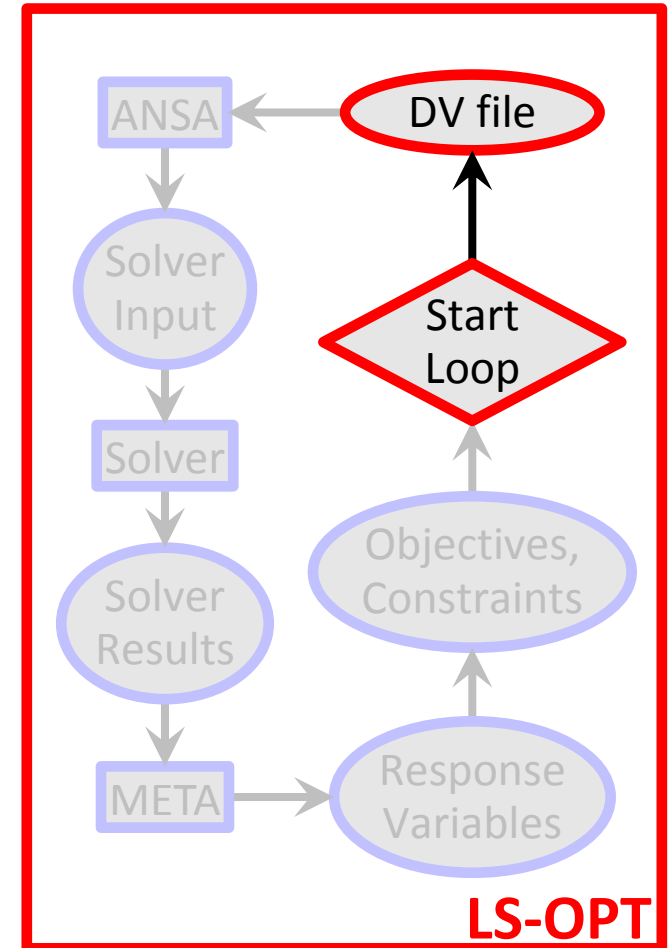

Optimization Run

LS-OPT → ANSA → Solver → META → LS-OPT

- ANSA reads DV from DV file,

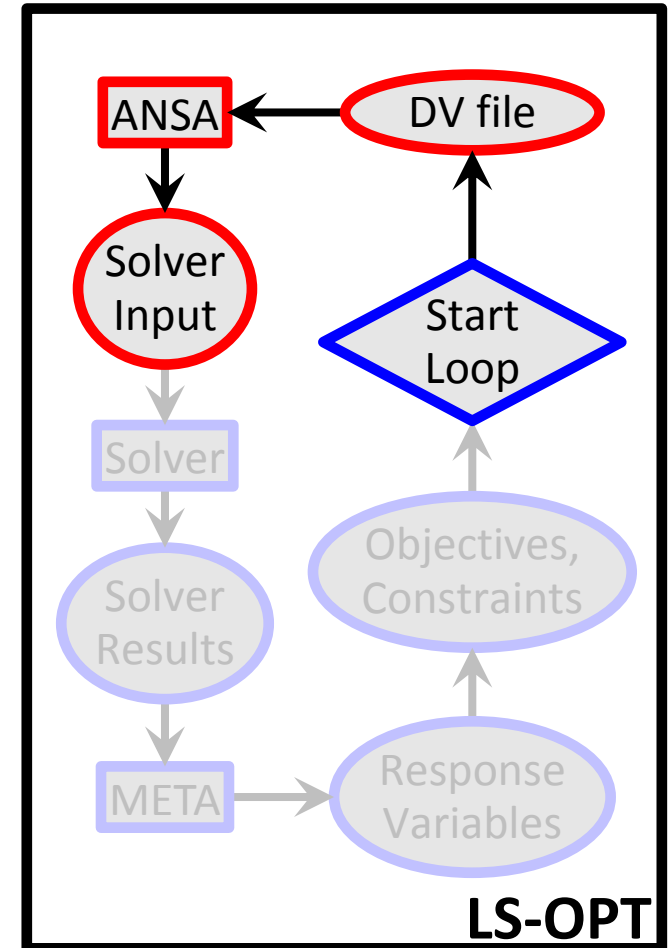

Optimization Run

LS-OPT → **ANSA** → Solver → META → LS-OPT

- ANSA reads DV from DV file,
- executes Optimization Task sequence

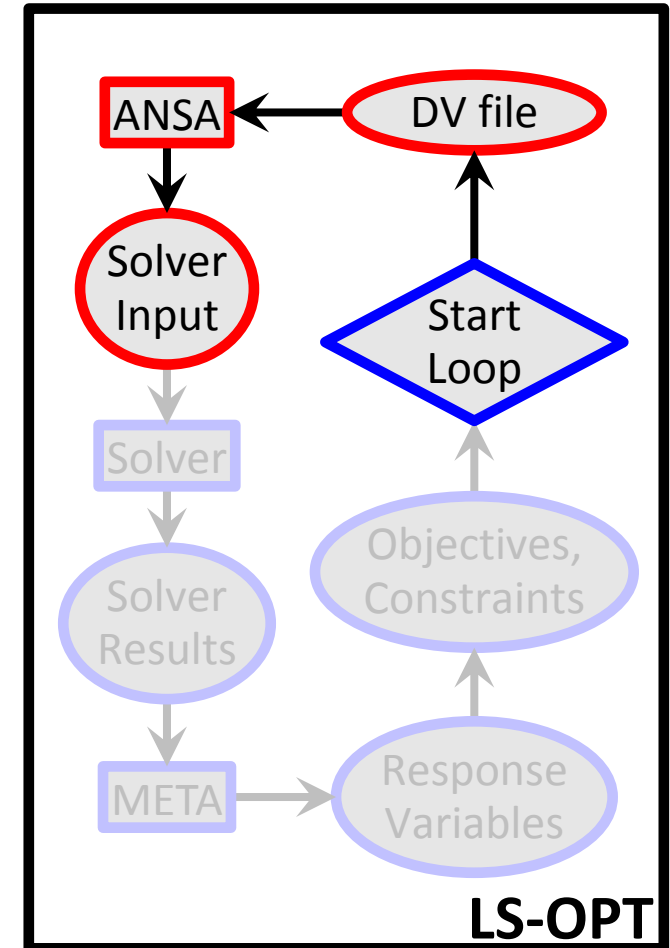
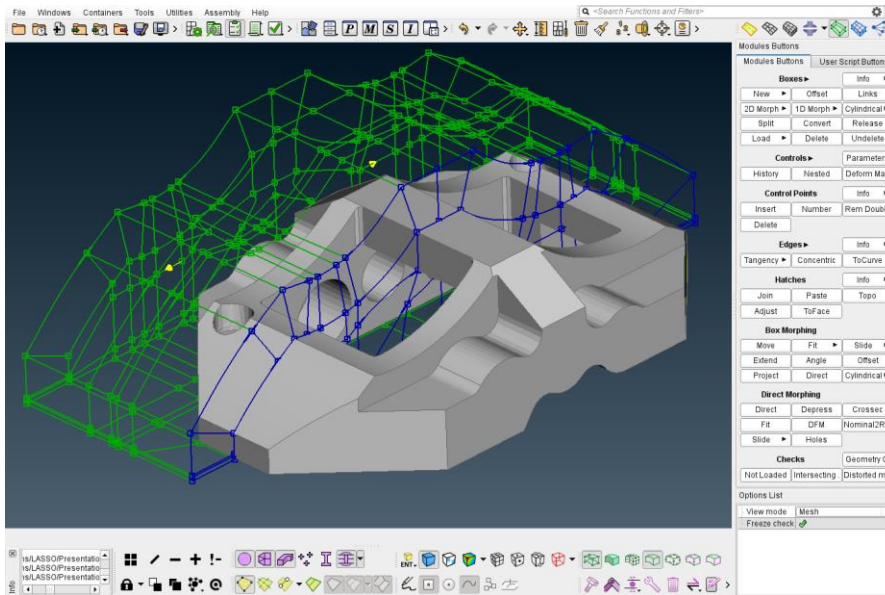

Optimization Run

LS-OPT → **ANSA** → Solver → META → LS-OPT

- ANSA reads DV from DV file,
- executes Optimization Task sequence

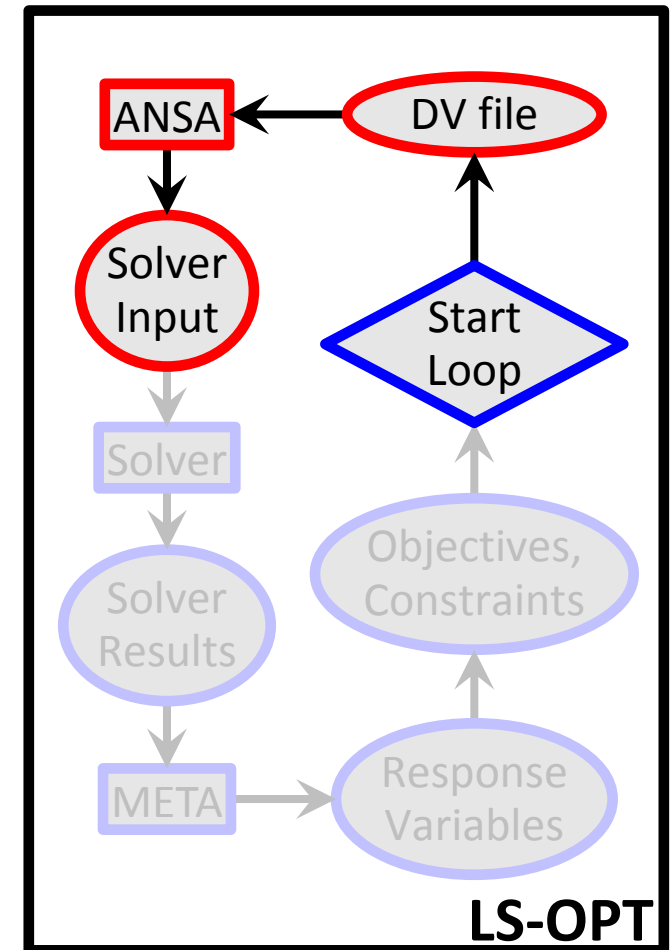
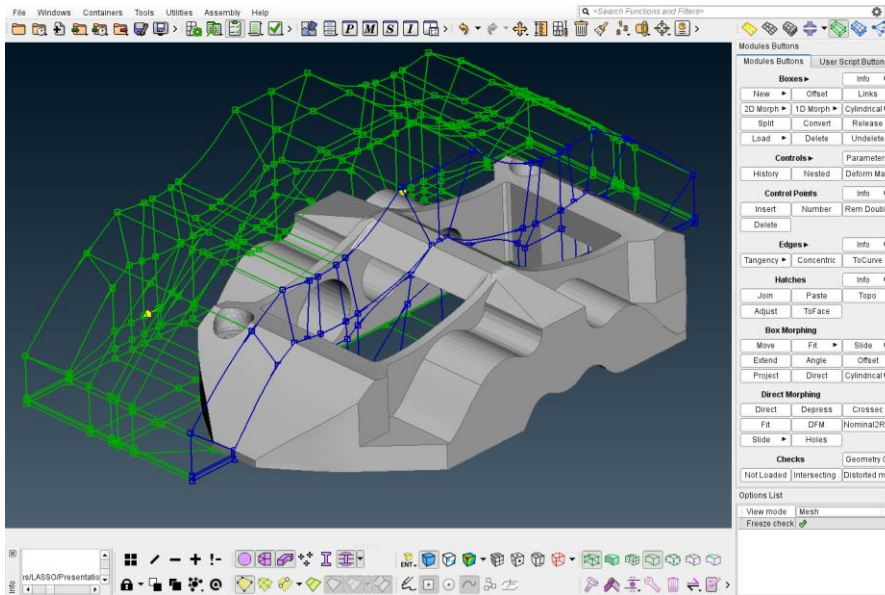

Optimization Run

LS-OPT → **ANSA** → Solver → META → LS-OPT

- ANSA reads DV from DV file,
- executes Optimization Task sequence
- and outputs solver input deck

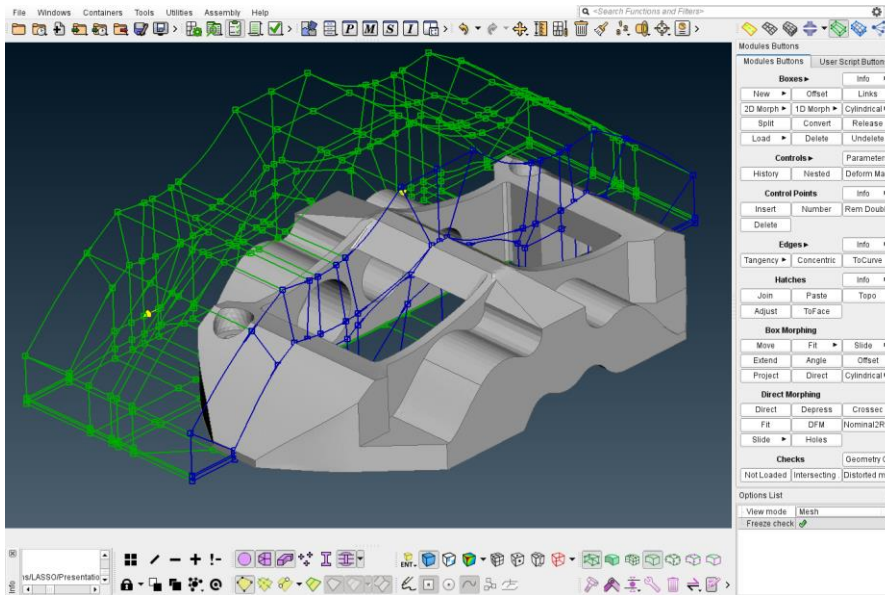

*.key / *.nas / *.inp

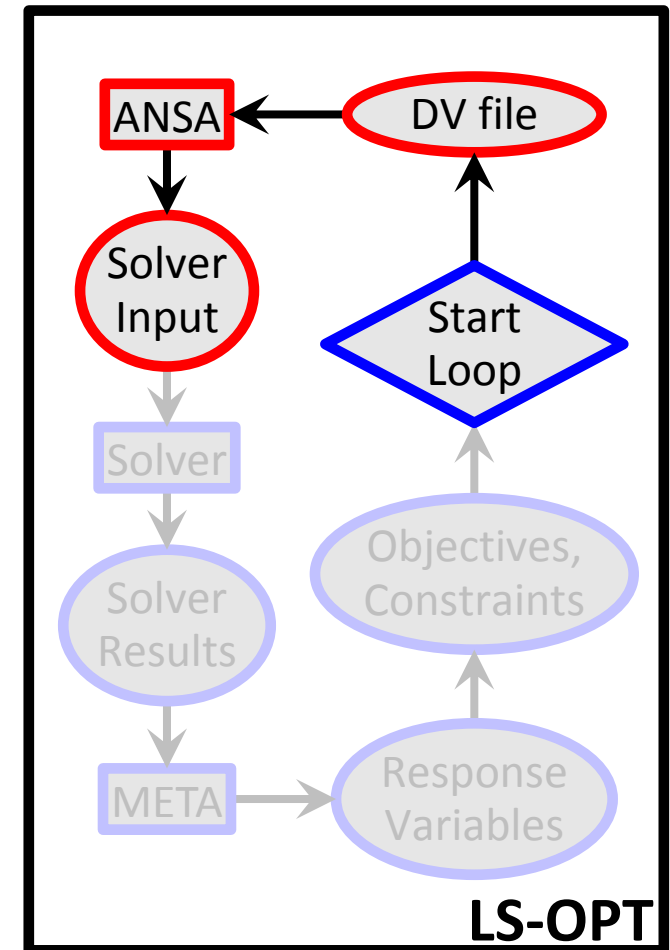

Optimization Run

LS-OPT → ANSA → **Solver** → META → LS-OPT

- LS-OPT invokes solver runs

*.key / *.nas / *.inp

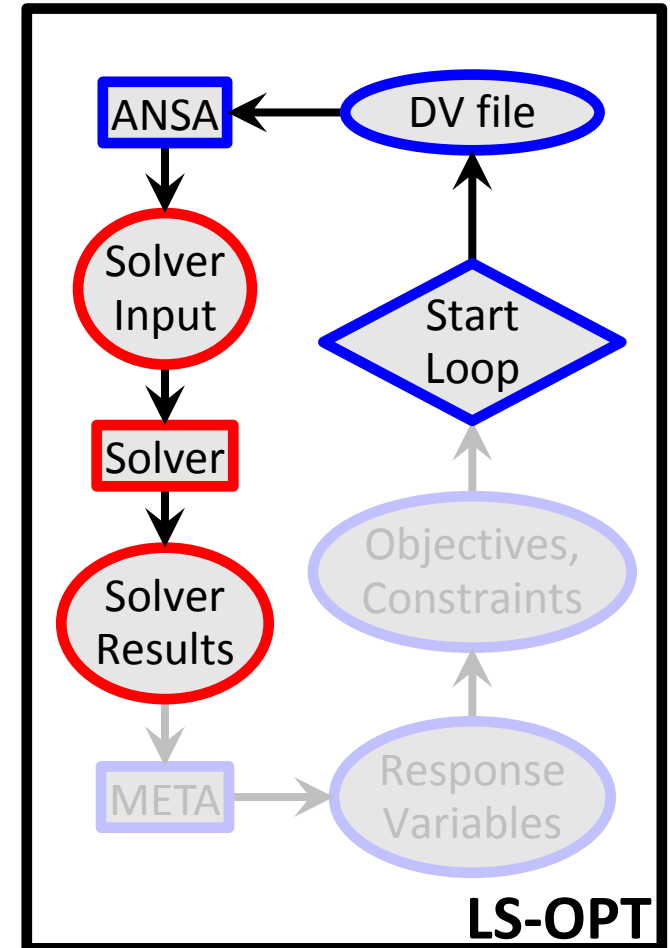
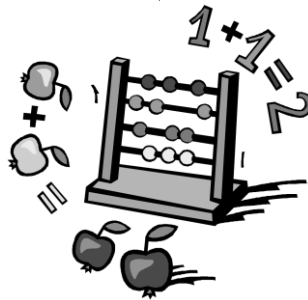

Optimization Run

LS-OPT → ANSA → **Solver** → META → LS-OPT

- LS-OPT invokes solver runs
- Solver produces result files

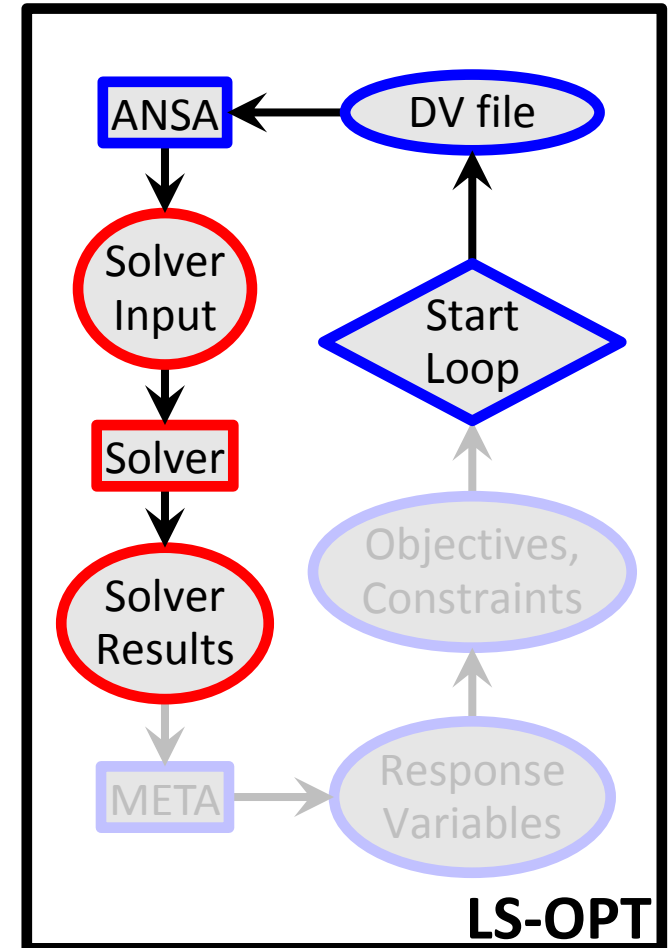
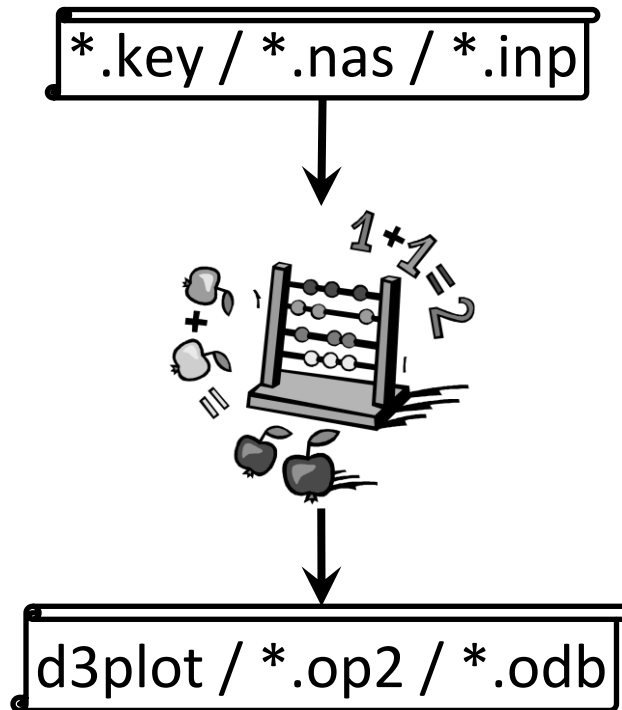

Optimization Run

LS-OPT → ANSA → Solver → **META** → LS-OPT

META extracts responses from solver result files

d3plot / *.op2 / *.odb

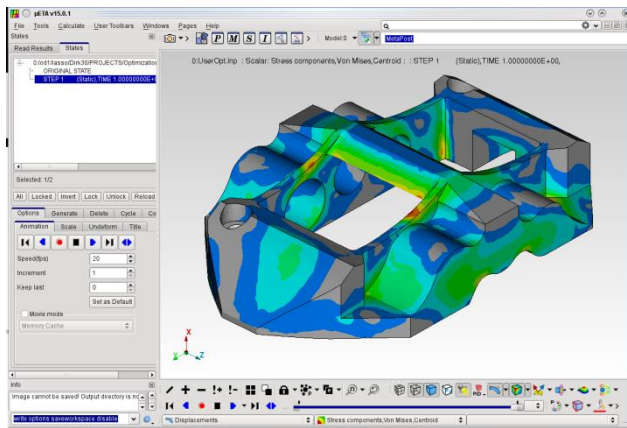

```
#OptimizerSetup Response & history File
RESPONSES
  1,nodes_rel_disp,0.174171448
  2,max_stress,169.780731
END
```

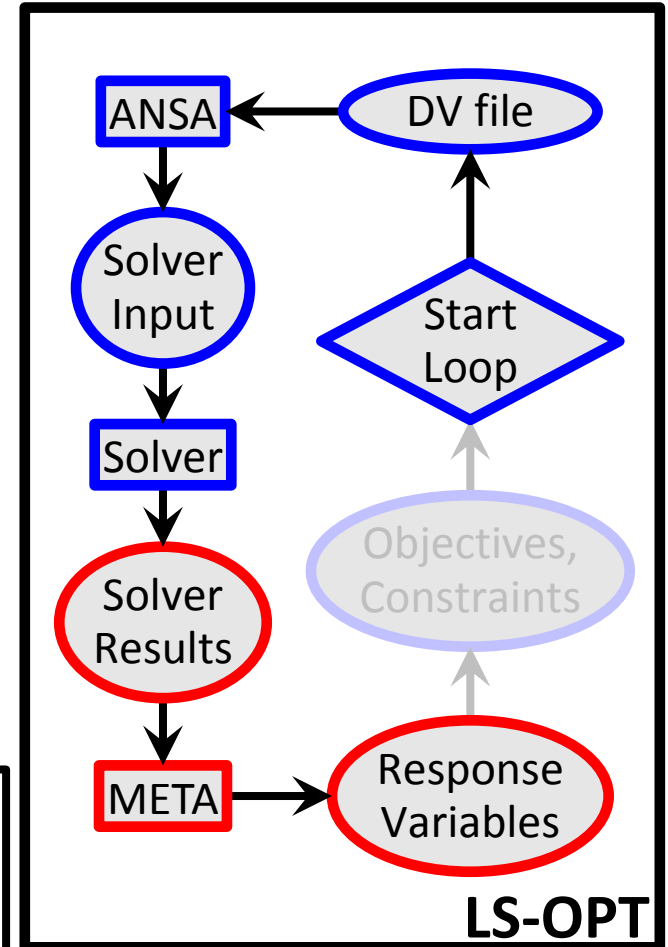

Optimization Run

LS-OPT → ANSA → Solver → META → **LS-OPT**

LS-OPT reads responses and evaluates objectives/constraints

```
#OptimizerSetup Response & history File
RESPONSES
1,nodes_rel_disp,0.174171448
2,max_stress,169.780731
END
```

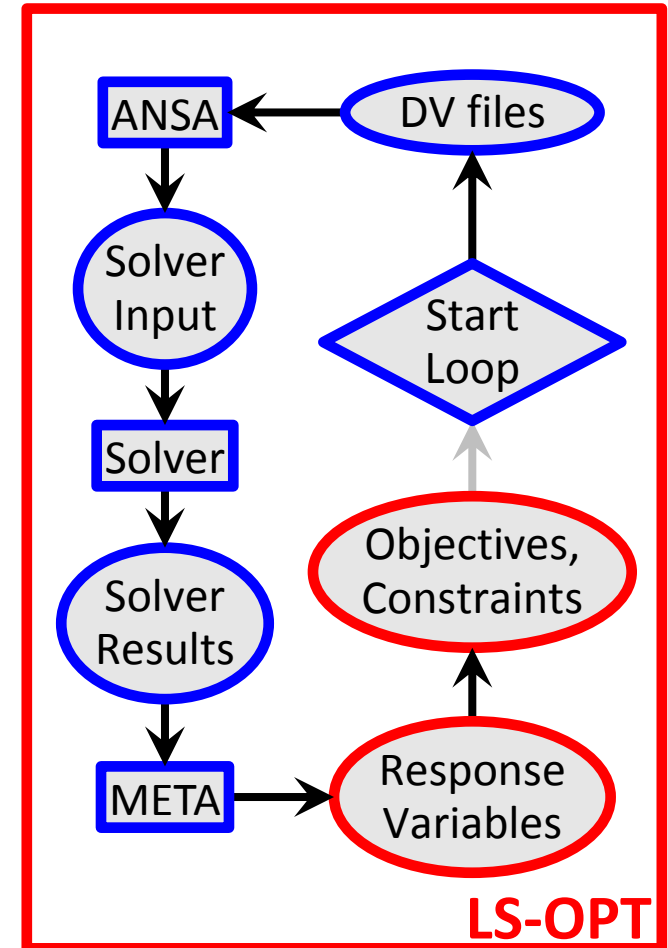
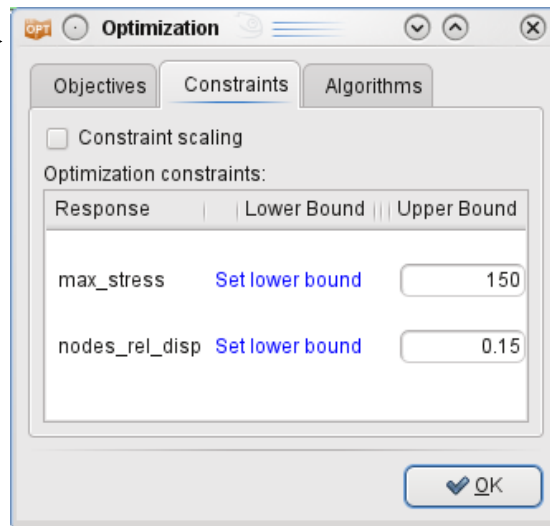

Optimization Run

LS-OPT → ANSA → Solver → META → **LS-OPT**

- LS-OPT calculates new values for DVs

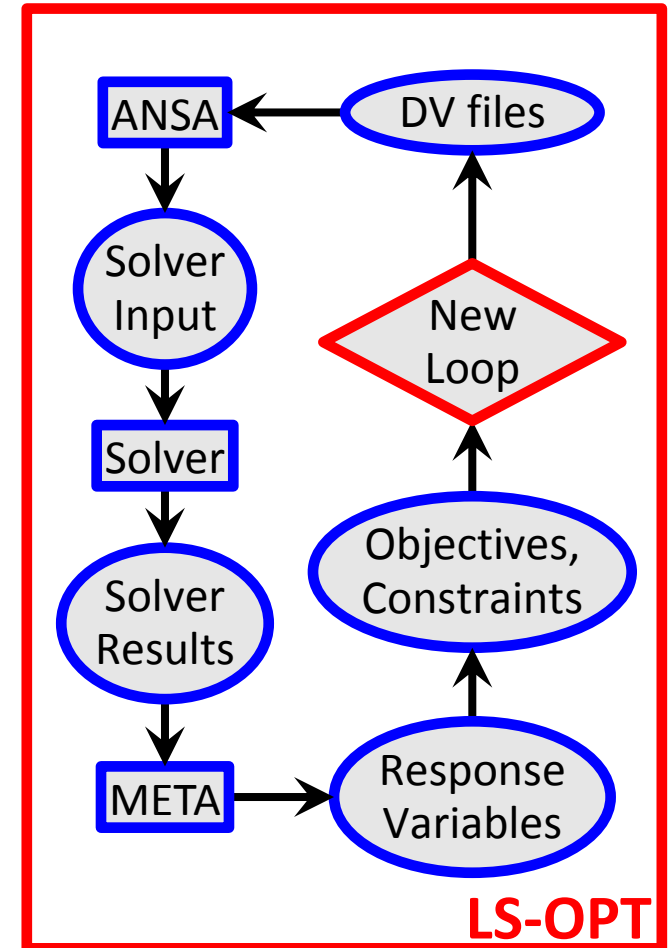

Optimization Run

LS-OPT → ANSA → Solver → META → **LS-OPT**

- LS-OPT calculates new values for DVs
- Whole process repeated until optimal solution

Initial

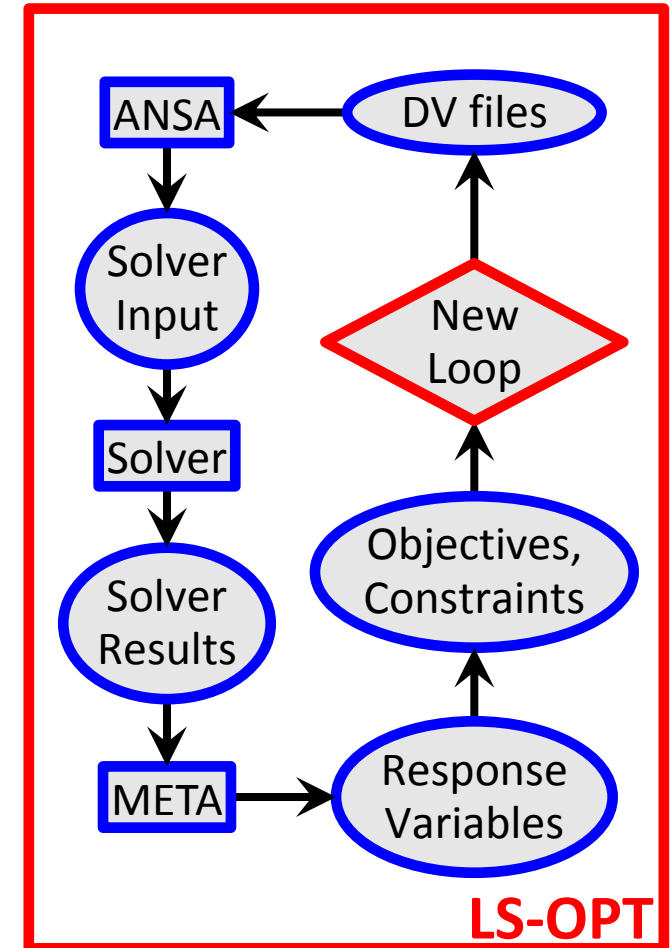
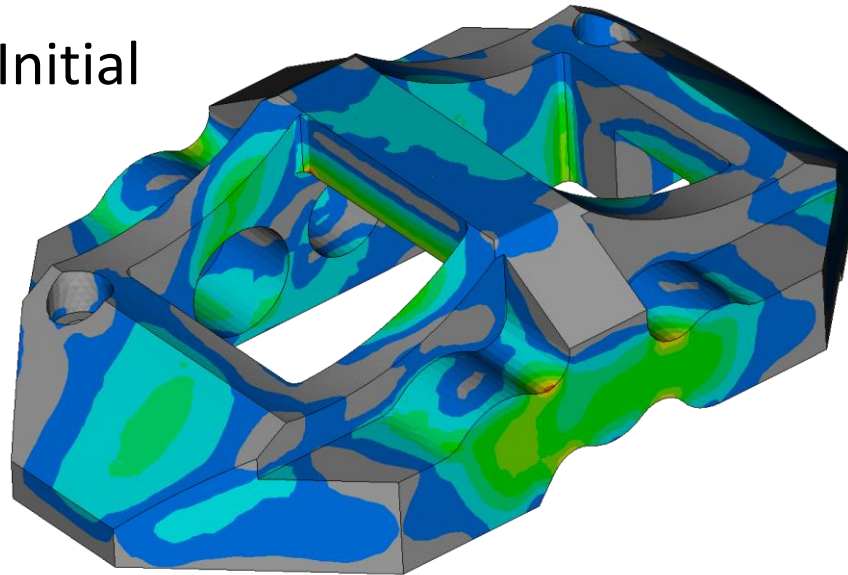

Optimization Run

LS-OPT → ANSA → Solver → META → **LS-OPT**

- LS-OPT calculates new values for DVs
- Whole process repeated until optimal solution

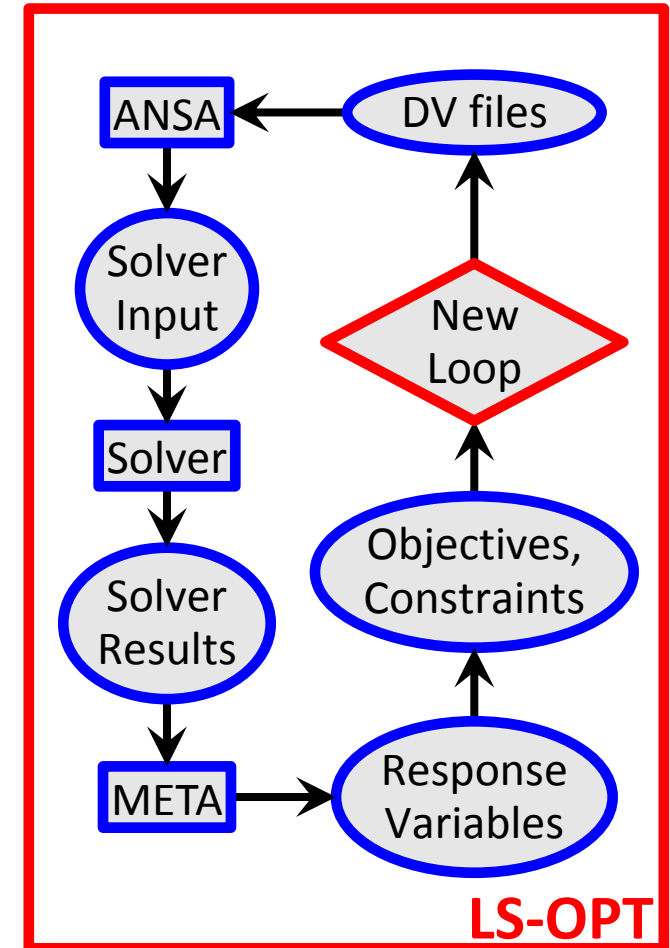
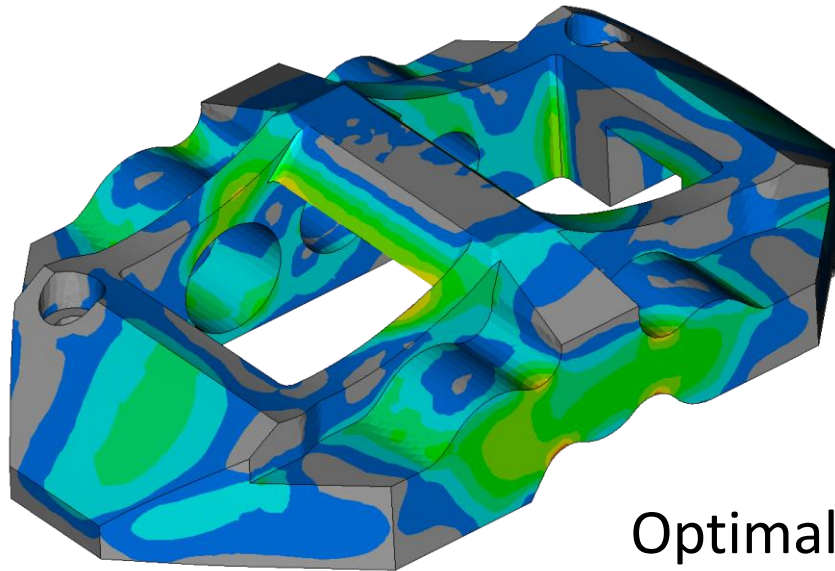

Ευχαριστώ πολύ

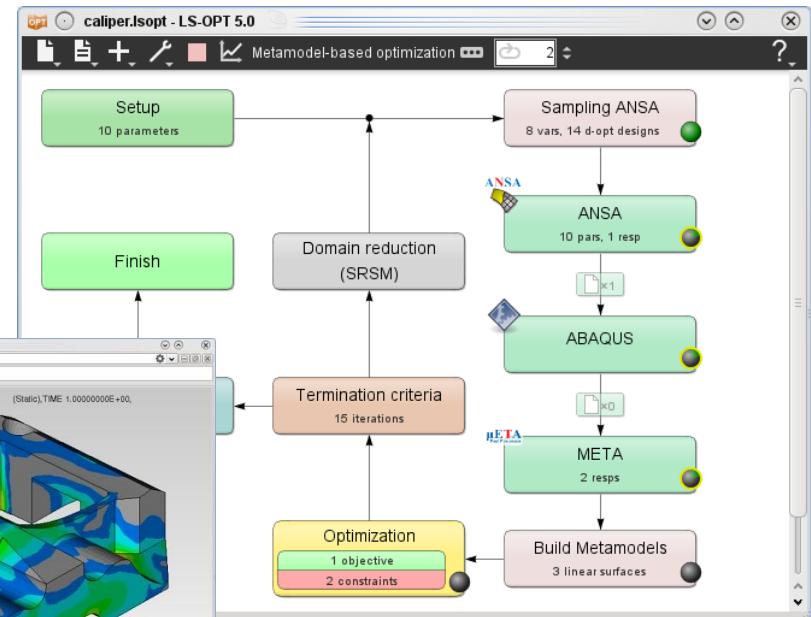
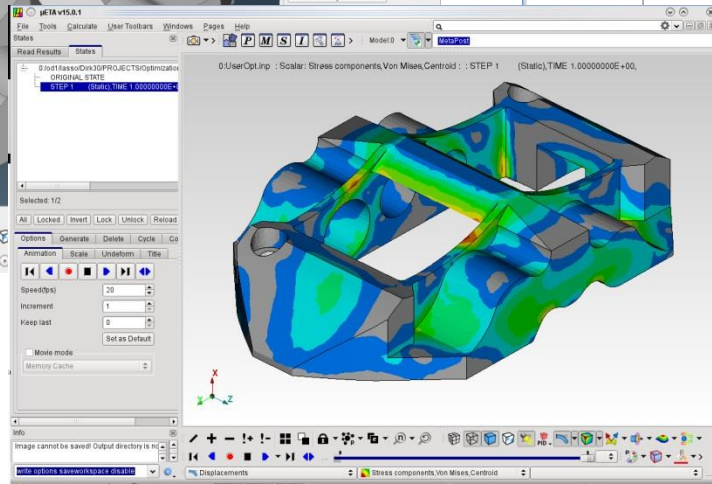
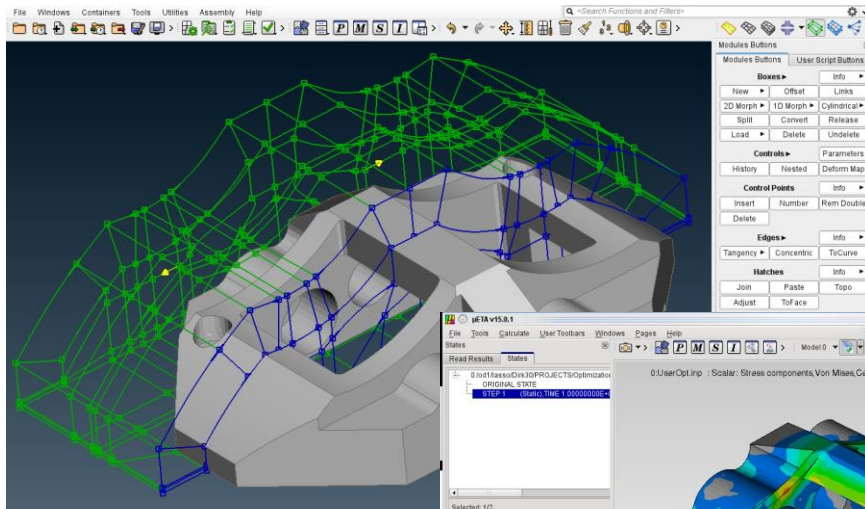

Ευχαριστώ πολύ

More information and examples on
www.lsoptsupport.com

Mail: ansa@lasso.de

