

Information day on Automotive and Aerospace Applications

Multiphysics Modeling of Li-Ion Batteries with LS-DYNA

Nils Karajan (DYNAmore)
Skylar Sible (DYNAmore Corp.)

Inaki Caldichoury, Pierre L'Eplattenier (ANSYS / LST)

1 December 2022, Berlin, Germany

Overview

- Motivation
- Modular Single Cell Model
 - Thermal Module
 - Electro-Magnetics (EM) Module
 - Exothermic Reaction Module
 - Extension to several cells with thermal contact
- Structural Module
 - Models on the microscale
 - Models on the mesoscale
 - Models on the macroscale
- Bringing it all together
 - Time separation strategies
- Conclusion & Future Work

Motivation

■ Greatest concern is the cascading cell failure in battery modules and packs

■ Goal is to understand

- Mechanisms that trigger separator failure
- If internal short circuit triggers a cell into a thermal runaway
- How does thermal runaway of a cell propagate through the module/pack
- How gas release causes structural damage or leaks in passenger cell

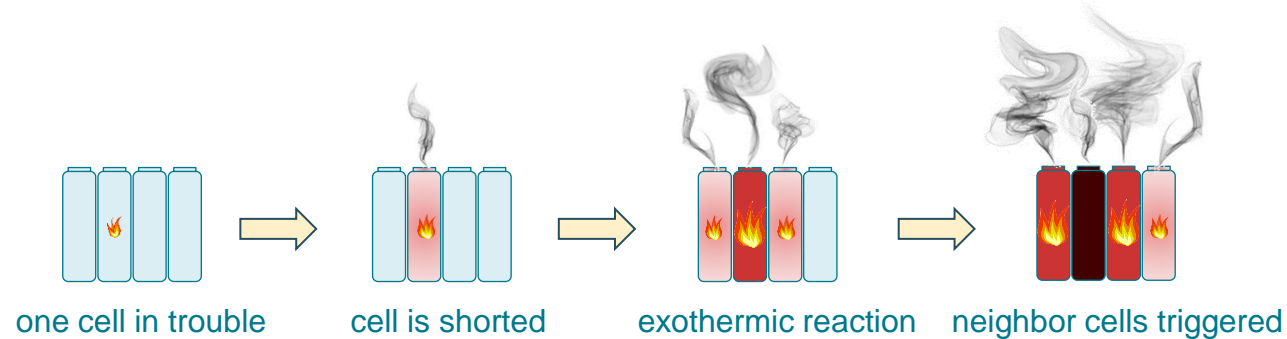

■ Build modular multi-physics model

- Thermal module to characterize heat flow
- Electro-magnetic (EM) module to characterize use and abuse
- Structural module to capture deformation and separator failure

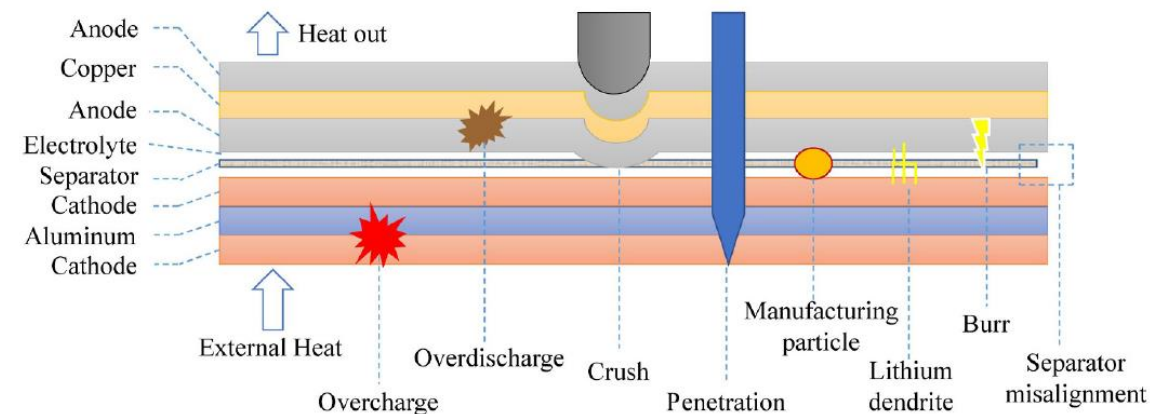

[Zhang, G., Wei, X., Tang, X., Zhu, J., Chen, S., & Dai, H. (2021)]

Modular Single Cell Model

Thermal Module

Thermal material model

- Orthotropic thermal conductivity of cell
 - In plane of the jelly roll layers (k_1 & k_2) is larger
 - Perpendicular (radial) to layers (k_3) is smaller
- Heat capacity C_p
- Density ρ
- Each cell needs own material due to different axis of symmetry

*MAT_THERMAL_ORTHOTROPIC							
\$#	tmid	tro	tgrlc	tgmult	aopt	tlat	hlat
	1002	2670.3			4		
\$#	hc	k1	k2	k3	a2	a3	
	928.0	25.8	25.8	0.998			
\$#	xp	yp	zp	a1			
	0.0	0.0	0.0				
\$#	d1	d2	d3				
	1.0	0.0	0.0				

locally orthotropic in cylindrical coordinate system with material axis of symmetry

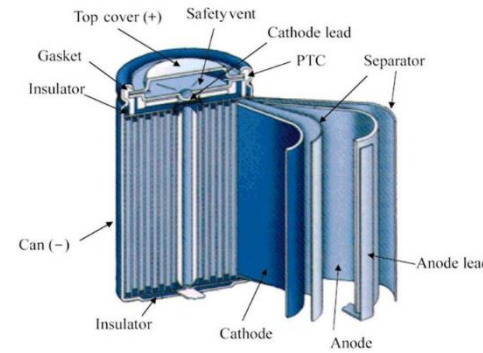

[Bankole et al. 2013]

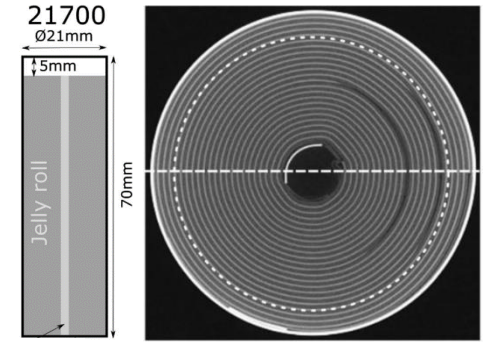

[Quinn et al. 2018]

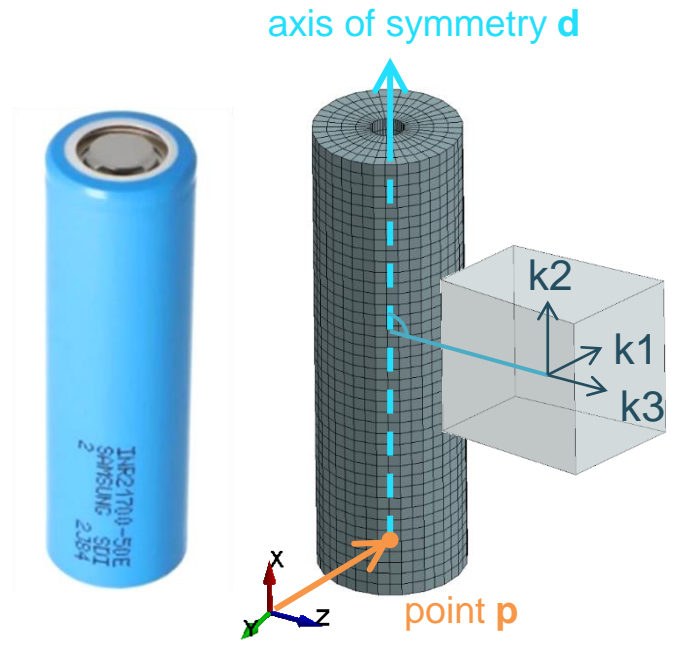

Heat transfer boundary conditions

Flux boundary condition for heating patch

- Application on segment set via
***BOUNDARY_FLUX_SET**

$$\dot{q} = \frac{P}{A} \quad \left\{ \begin{array}{l} P = \text{power in Watt} \\ A = \text{segment set area in m}^2 \end{array} \right.$$

- Surface temperature depends on heating power
- Temperature at 1000 seconds

Power	Simulation	Experiment
10 W	89.0 °C	90.0 °C
20 W	152.0 °C	150.0 °C
30 W	216.0 °C	220.0 °C
40 W	278.0 °C	280.0 °C

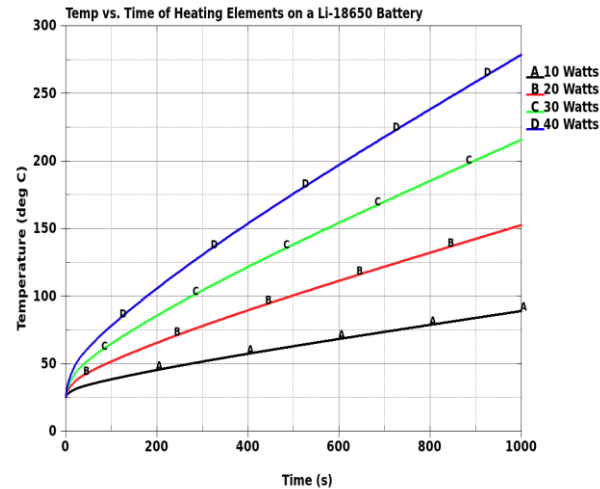
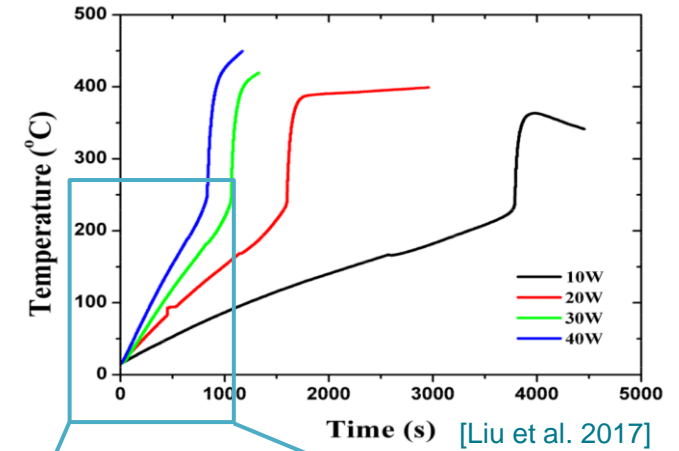
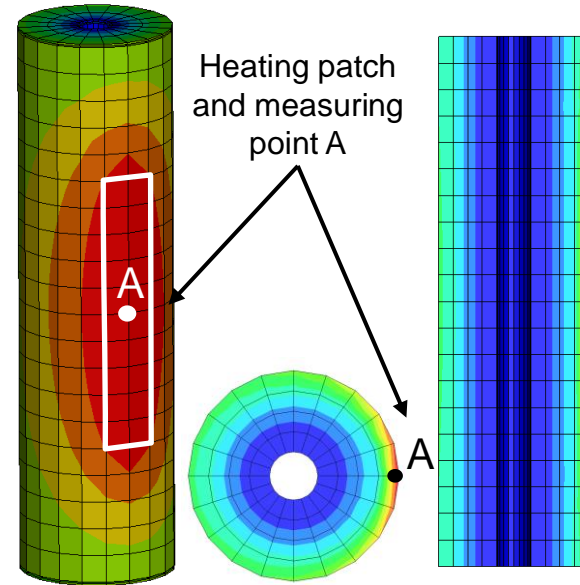

simulation

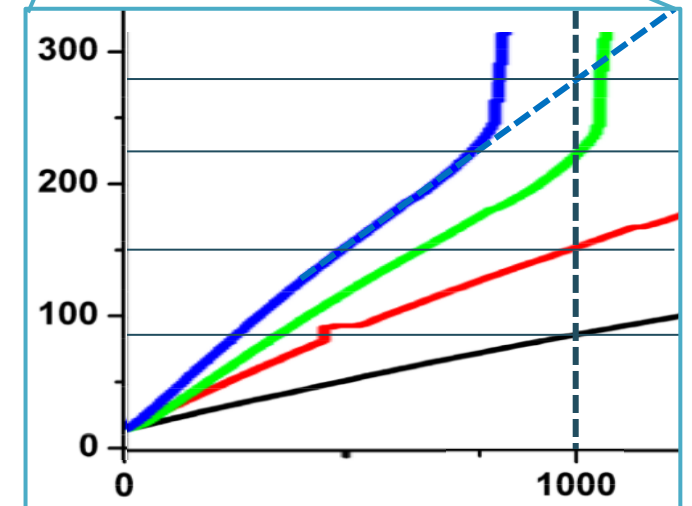

experiment

■ Heat transfer boundary conditions

■ Convection model on segment set

```

*BOUNDARY_CONVECTION_SET
$#  ssid      pserod
    10021
$#  hlcid      hmult      tlcid      tmult      loc
    -10020      1.0      10022      1.0
    
```

h vs temp curve ID
and h multiplier

T_∞ vs time curve ID
and T_∞ multiplier

$$\dot{q} = hA(T - T_\infty)$$

■ Typical heat transfer coefficients

- Free convection: $3 \frac{W}{m^2K} < h < 9 \frac{W}{m^2K}$
- Forced convection: $h \gg 10 \frac{W}{m^2K}$
- Exact values need to be obtained by CFD simulations → Fluent

■ Surface radiation to open space (environment)

```

*BOUNDARY_RADIATION_SET
$#  ssid      TYPE
    10021      1
$#  flcid      fmult      tlcid      tmult      loc
    -10021      1.0      10022      1.0
    
```

f vs temp curve ID
and f multiplier

T_∞ vs time curve ID
and T_∞ multiplier

$$\dot{q} = \overbrace{\varepsilon \sigma F}^f A (T^4 - T_\infty^4)$$

Surface view factor (here 1.0)
Stefan Boltzmann constant
Emissivity (here 1.0)

- Typically, f equals the Stefan Boltzmann constant
- Temperature needs to be in Kelvin!
- Exact radiation model uses view factors (expensive)

Electro-Magnetics (EM) Module

- Battery modeling requires the simplified resistive heating solver and not all Maxwell equations
- The unit cell is the basic electrochemical unit comprised of an
 - Anode, cathode, separator, electrolyte in between two current collectors (positive and negative)
 - Anode and cathode store the Lithium
 - Electrolyte carries positively charged Lithium ions
 - The separator is a selectively permeable membrane that can be passed only by Lithium ions
 - Ions move from cathode to anode during charging, vice versa during discharging
 - The movement of the lithium ions creates free electrons in the anode which creates a charge at the positive current collector through a device being powered to the negative current collector

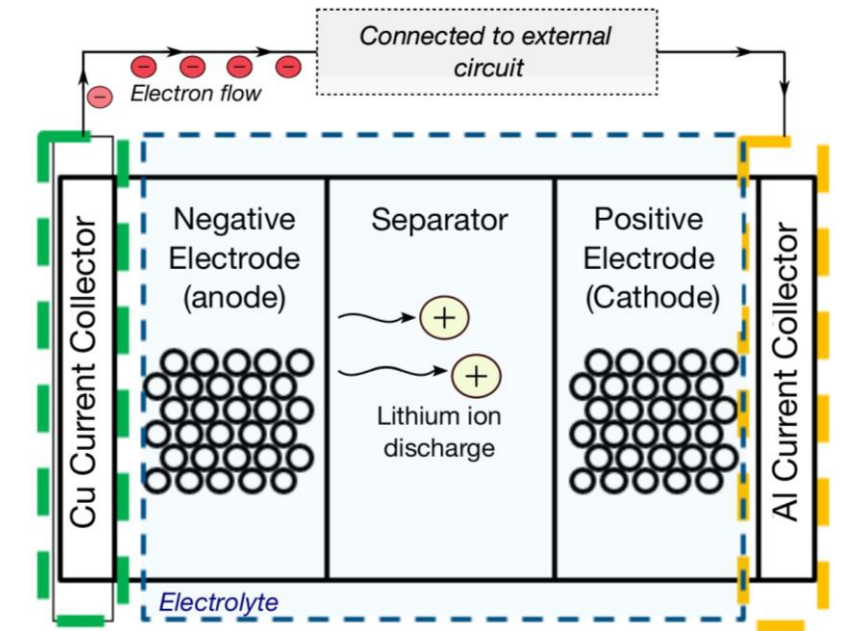

■ Equivalent lumped electric circuit model

■ Computing the ion movement is possible but computationally intense

■ Solving the electrolyte in a porous chemically active anode & cathode is only useful in battery design

■ Idea: Define a set of equations that easily capture the gross behavior of the battery

□ Randles circuit is one of many approaches to this idea

- $\phi_{N/P}$ potential at anode & cathode
- *OCV*: open circuit voltage as ideal voltage source
- R_0 : solution resistance
- R_{10} : charge-transfer resistance
- C_{10} : double-layer capacitance

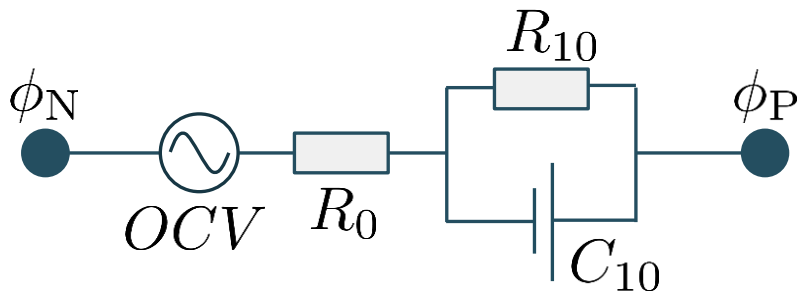

lumped electric circuit model

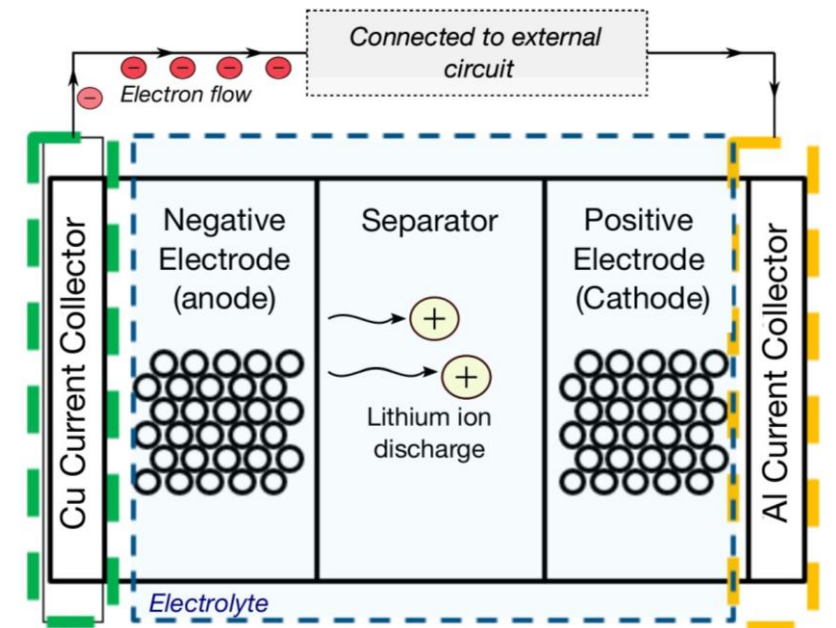

- The distributed Randles model
- Idea: Use several Randles circuits in parallel to account for 3d distribution in the battery
 - Circuits are placed between corresponding nodes on the two current collectors
 - Circuit elements depend on current direction and can be functions of state of charge (SOC) and temperature
 - This allows to capture localized discharge during internal short

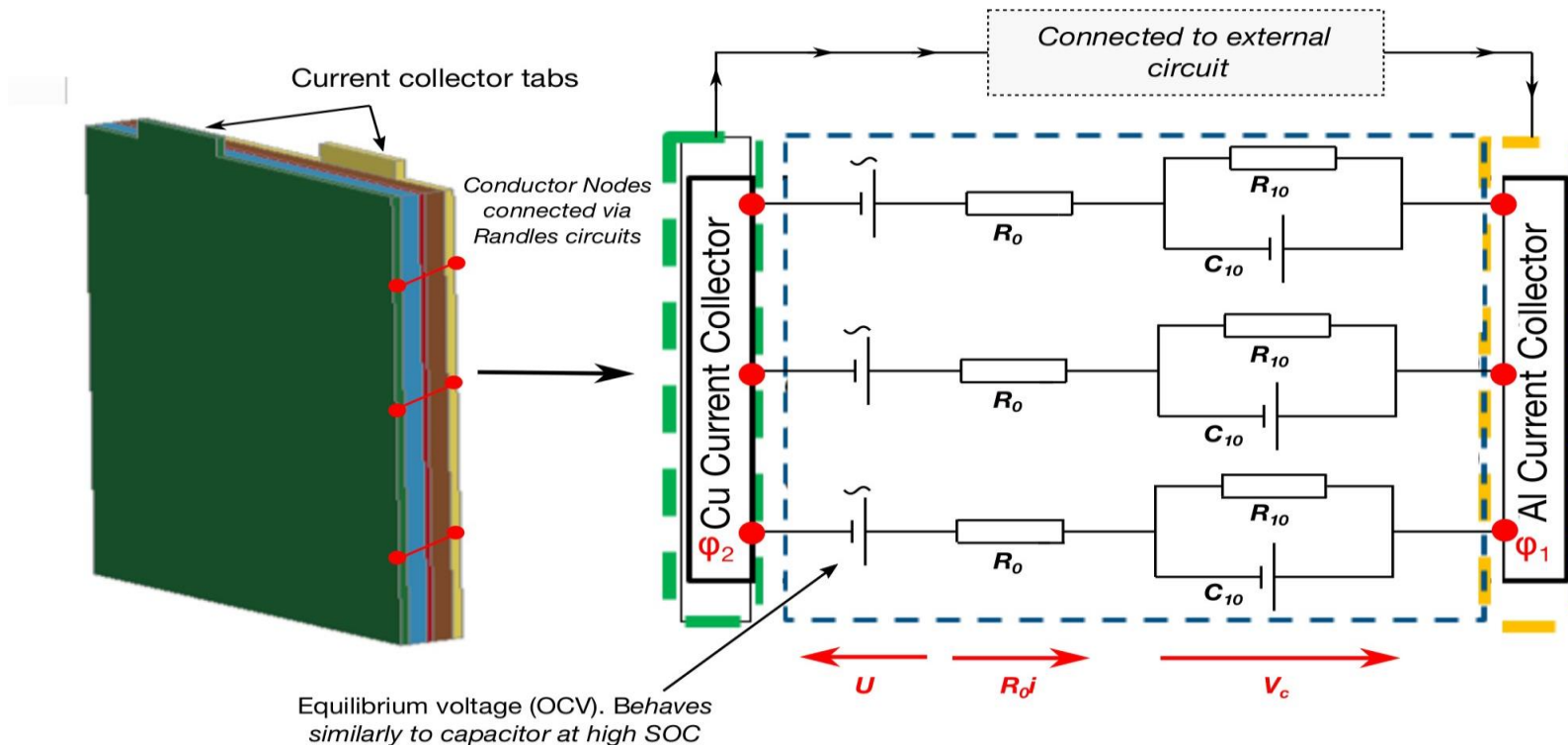

■ Available Randle circuit models depending on scale & level of detail

- Micro scale on cell level: Solid elements for each layer
 - All the layers of the jelly roll are meshed using solid elements
 - Same mesh used for mechanics, thermal and EM
 - Drawback: many elements with large aspect ratio & small mech. time step
- Meso scale on cell/module level: TSHELLS with *PART_COMPOSITE
 - Mechanics part modeled using composite thick shells
 - EM and thermal use automatically generated solid mesh
 - Faster runs (mechanics solver has less elements with larger time step)
- Macro scale for cell/module/pack level: Solid elements for everything
 - One (or a few) solid elements through thickness for mechanics, EM and thermal
 - 2 fields at each node (positive and negative current collectors)
 - Computationally cheap which allows for pack level simulations
- Meshless model: module/pack level: External circuit only
 - One single equivalent circuit for the whole cell (lumped model)

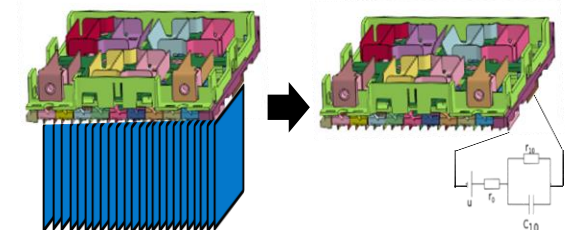
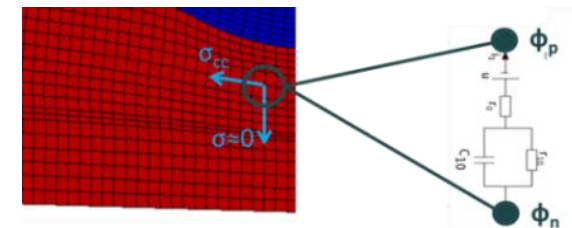
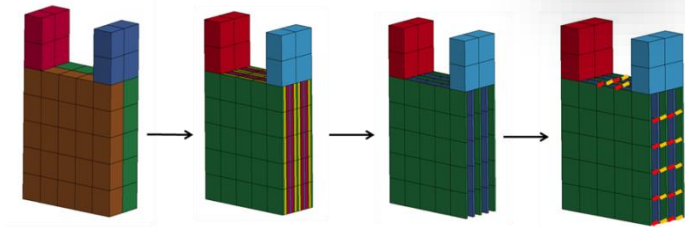
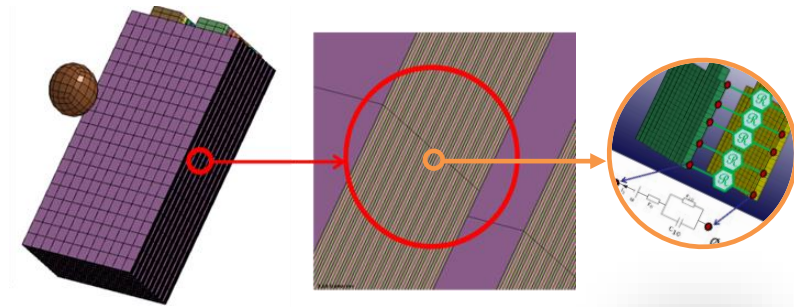

[L'Eplattenier & Çaldichoury 2019]

Material cards for the BatMac model

- Isotropic electrical conductivity of aluminum collector tabs σ_{tab}^+ , σ_{tab}^-

```
*EM_MAT_001
$# mid mtype sigma eosid
    1002 2 36.9e6
```

- Anisotropic electrical conductivity of anode and cathode σ_p , σ_n

- Local orthotropy define like in the thermal material card

```
*EM_MAT_005
$# mid mtype sigXXp sigYYp sigZZp
    1002 5 669.5 669.5 2.0
$# sigXYp sigXZp sigYXp sigYZp sigZXp sigZYp
$# sigXXn sigYYn sigZZn
    1760.0 1760.0 2.0
$# sigXYn sigXZn sigYXn sigYZn sigZXn sigZYn
$# aopt xp yp zp a1 a2 a3
    4 0.0 0.0 0.0
$# v1 v2 v3 d1 d2 d3
    1.0 0.0 0.0
```

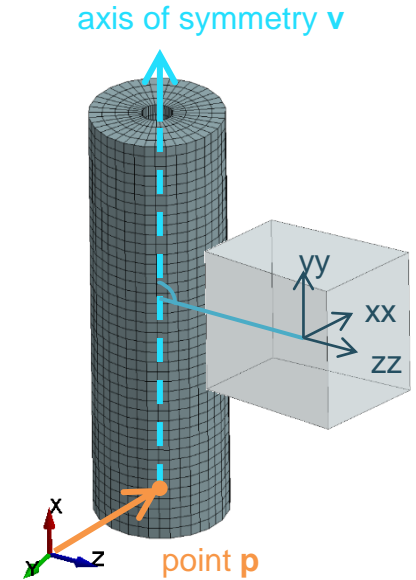
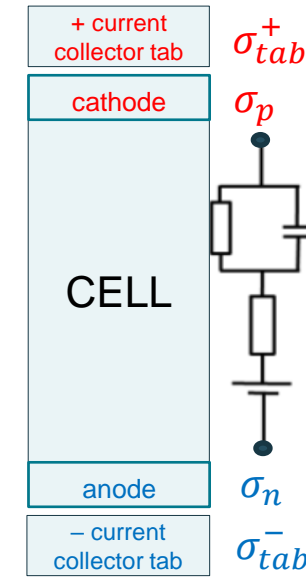

- | | |
|---|-----------------------------------|
| 1 Positive pole | 5 Insulator |
| 2 Positive Temperature Coefficient Device (PTC) | 6 Cathode |
| 3 Gasket | 7 Anode |
| 4 Collector | 8 Negative pole (cell can) |
| | 9 Separator |
| | 10 Current Interrupt Device (CID) |
| | 11 Exhaust gas hole |

■ Internal short circuit model during abuse

■ Short can be triggered based on combinations

- Stress, strain, displacement, current, temperature, etc.
- In case of an internal short, the respective Randle circuit is replaced by a resistance
- Battery will then discharge through the shorted area which triggers resistive heating
 - SOC will go to zero after discharge
- Here: Trigger temperature of the short is 180 °C (453 K)

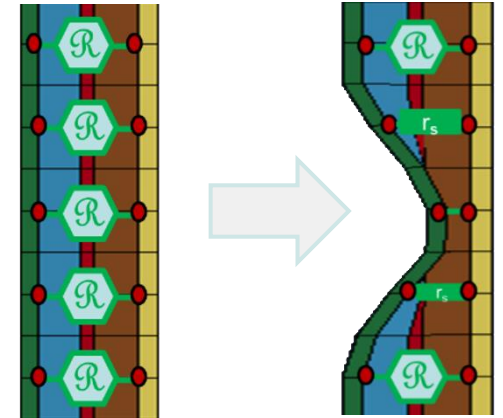

```
*EM_RANDLES_SHORT
$#areaType  functId
      3      501

*DEFINE_FUNCTION
$#      fid      heading
      501

float resistance_short_randle(float time,
                             float temp) {
  if (temp >= 273.0 + 180.0) {
    return 0.1;
  }else {
    return -0.1;
  }
}
```

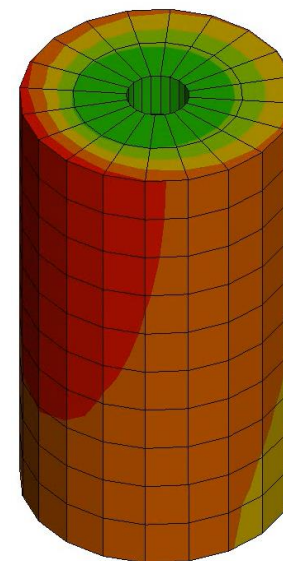

Temperature

1.800e+02
1.645e+02
1.490e+02
1.335e+02
1.180e+02
1.025e+02
8.700e+01
7.150e+01
5.600e+01
4.050e+01
2.500e+01

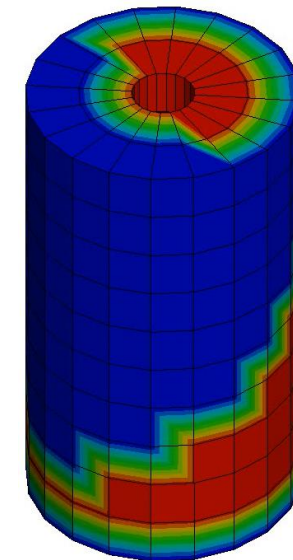

randle soc

1.000e+02
9.000e+01
8.000e+01
7.000e+01
6.000e+01
5.000e+01
4.000e+01
3.000e+01
2.000e+01
1.000e+01
0.000e+00

Exothermic Reaction Models

- Decomposition reaction models are used to capture chemical reaction kinetics
- Approaches with analytical equations for the heat generation S

- ***LOAD_HEAT_EXOTHERMIC_REACTION**

- One-equation model (MacNeil et al. 2001)

- Heat generation S by one exothermic reaction depending on temperature and constant input parameters

$$R(T, \alpha) = A_{sei} \times \alpha^{m_{sei}} \times (1 - \alpha)^n \times (-\ln(1 - \alpha))^p \times \exp\left(-\frac{E_{a,sei}}{R_u T}\right)$$

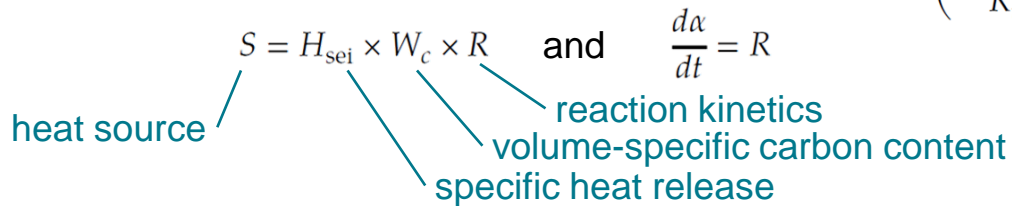

- NREL's four equation model (Kim et al. 2007)

- Separate heat generation from the decomposition reaction of the four components, i.e. solid electrolyte interface (sei), negative (ne) & positive (pe) electrode, electrolyte (ele)

$$S_{abuse_chem} = S_{sei} + S_{ne} + S_{pe} + S_{ele}$$

Many parameters to determine!

$$R_{sei}(T, c_{sei}) = A_{sei} \times \exp\left(-\frac{E_{a,sei}}{R_u T}\right) \times c_{sei}^{m_{sei}}$$

$$S_{sei} = H_{sei} \times W_c \times R_{sei}$$

$$\frac{dc_{sei}}{dt} = -R_{sei}$$

$$R_{pe}(t, \alpha) = A_{pe} \times \alpha^{m_{pe,p1}} \times (1 - \alpha)^{m_{pe,p2}} \times \exp\left(-\frac{E_{a,pe}}{R_u T}\right)$$

$$S_{pe} = H_{pe} \times W_p \times R_{pe}$$

$$\frac{d\alpha}{dt} = R_{pe}$$

$$R_{ne}(T, c_{neg}, t_{sei}) = A_{ne} \times \exp\left(-\frac{t_{sei}}{t_{sei,ref}}\right) \times c_{neg}^{m_{ne,n}} \times \exp\left(-\frac{E_{a,ne}}{R_u T}\right)$$

$$S_{ne} = H_{ne} \times W_{cne} \times R_{ne}$$

$$\frac{dc_{neg}}{dt} = -R_{ne}$$

$$\frac{dt_{sei}}{dt} = R_{ne}$$

$$R_e(T, c_e) = A_e \times \exp\left(-\frac{E_{a,e}}{R_u T}\right) \times c_e^{m_e}$$

$$S_{ele} = H_e \times W_e \times R_e$$

$$\frac{dc_e}{dt} = -R_e$$

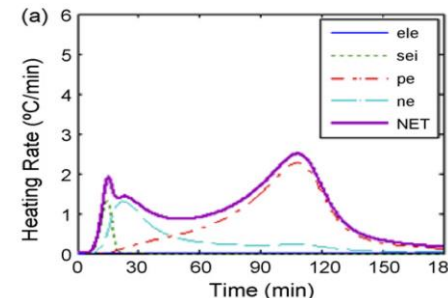

[Kim et al. 2007]

- Engineering approach via curve definition for the exothermic energy release rate vs. temperature
 - Start with normalized energy release rate curve and scale with $\&hexo$ to fit sparse experimental data

```

*EM_RANDLES_EXOTHERMIC_REACTION
$#areaType  functId
           2      511

*DEFINE_FUNCTION
$#      fid      heading
           511

float exothermic_reaction_randle(float time,
                                float temp,
                                float H_ex) {

float t_burn = 273.0 + 247.0;
float H_max = 2.4;
if (temp > t_burn && H_ex < H_max) {
  return  $\&hexo$ *H_releaseVsT(temp-t_burn+offset);
} else {
  return 0.0;
}}

*DEFINE_FUNCTION_TABULATED
$#      fid
           512

$# title
H_releaseVsT
$#      Temperature      H_release
           0.000          0.0010
           7.198          0.0057
           14.89          0.0194
           ...            ...

```

definition of exothermic release rate

ignition temperature

max. accumulated energy

burn only if ignition temp. t_{burn} is reached and not fully decomposed yet

activation offset

tune T_{burn} , H_{max} , $\&hexo$, offset to match experimental results

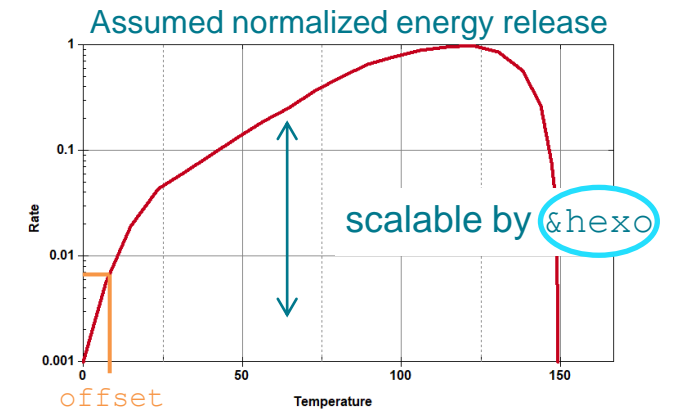
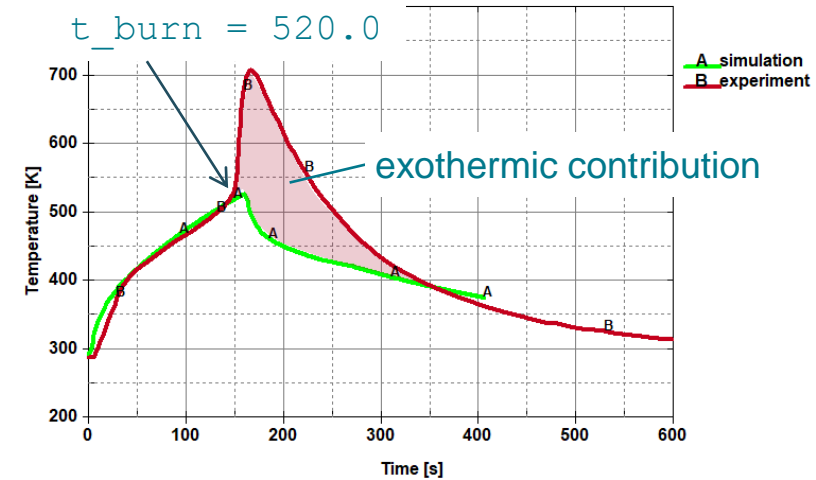

Proof of concept

■ Simulation results

- Good agreement of the voltage drop
- Good agreement of the temperature increase but room for improvement during cool down
 - Simulation results show temperature average of all surface nodes in the middle while experiment is at single point
 - Depends strongly on thermal boundary conditions but simplified convection models are always fuzzy without CFD
- Batteries in a module/pack are usually connected by thermal paste such that there is no void space
 - Thermal propagation through contact plays probably bigger role than convection/radiation into free air

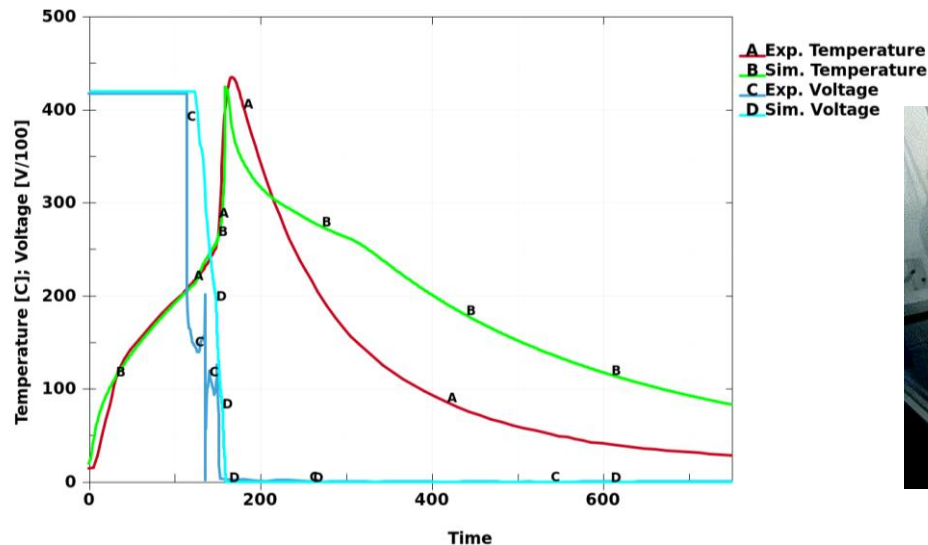

[Golubkov et al. 2018]

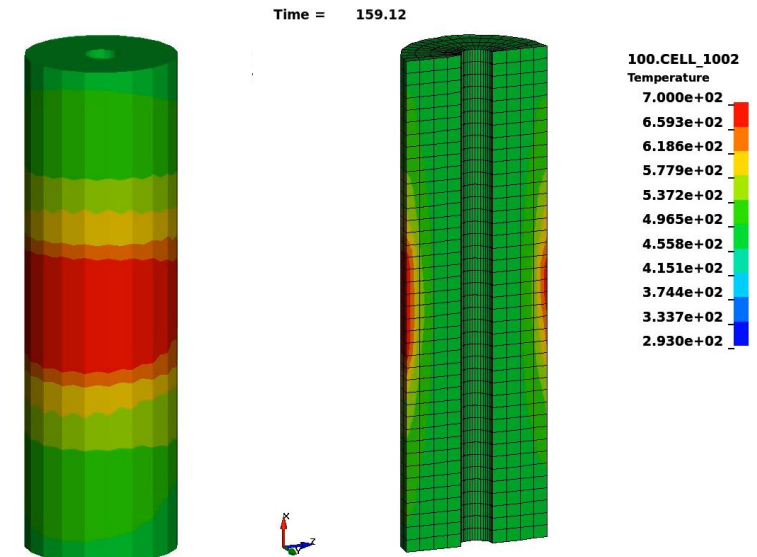

Extension to several cells

- Additional THERMAL option for the contact definition
 - Simple heat transfer model by contact, conduction through air and radiation
 - No view factor computation involved to solve boundary radiation problem
 - K: thermal conductivity of fluid between contact surfaces
 - FRAD: radiation factor between the contact surfaces
 - H0: heat transfer conductance for closed gaps
 - LMIN / LMAX: minimum / maximum gap size

Thermal Card 1.

THRM 1	1	2	3	4	5	6	7	8
Variable	K	FRAD	H0	LMIN	LMAX	FTOSLV	BC_FLG	ALGO
Type	F	F	F	F	F	F	I	I
Default	none	none	none	none	none	0.5	0	0

$$h_{\text{cond}} = \frac{K}{l_{\text{gap}}}$$

$$f_{\text{rad}} = \frac{\sigma}{\frac{1}{\varepsilon_1} + \frac{1}{\varepsilon_2} - 1}$$

σ = Stefan-Boltzman constant
 ε_1 = emissivity of master surface
 ε_2 = emissivity of slave surface

$$h = \begin{cases} h_0 & 0 \leq l_{\text{gap}} \leq l_{\text{min}} \\ h_{\text{cond}} + h_{\text{rad}} & l_{\text{min}} < l_{\text{gap}} \leq l_{\text{max}} \\ 0 & l_{\text{gap}} > l_{\text{max}} \end{cases}$$

Asymmetric heating ←

influence radius
 $(l_{\text{min}} < l_{\text{gap}} < l_{\text{max}})$

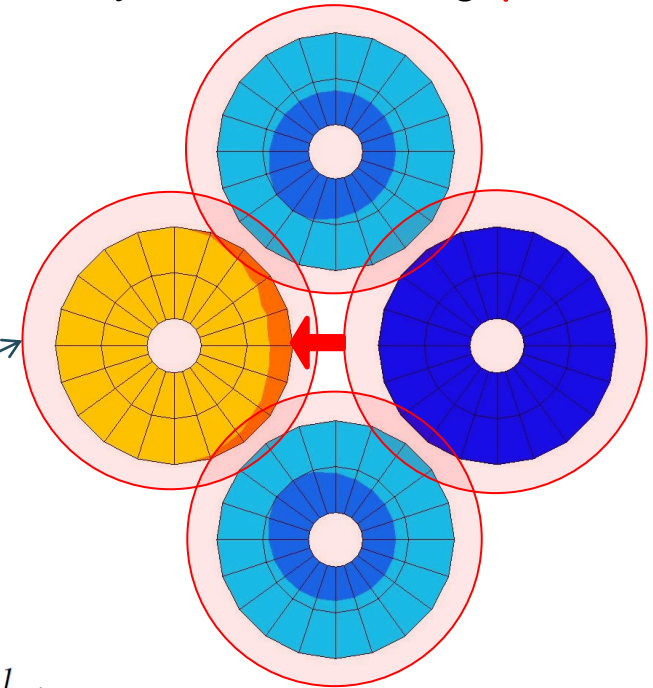

■ Cascading cell failure with different heating patch application

■ Relationship Between Voltage Drop and Temperature Jump

■ Circuit shorts when temperature at the node reached 180 deg. C

□ Here: Thermal convection and radiation boundary not included; different exothermic energy release

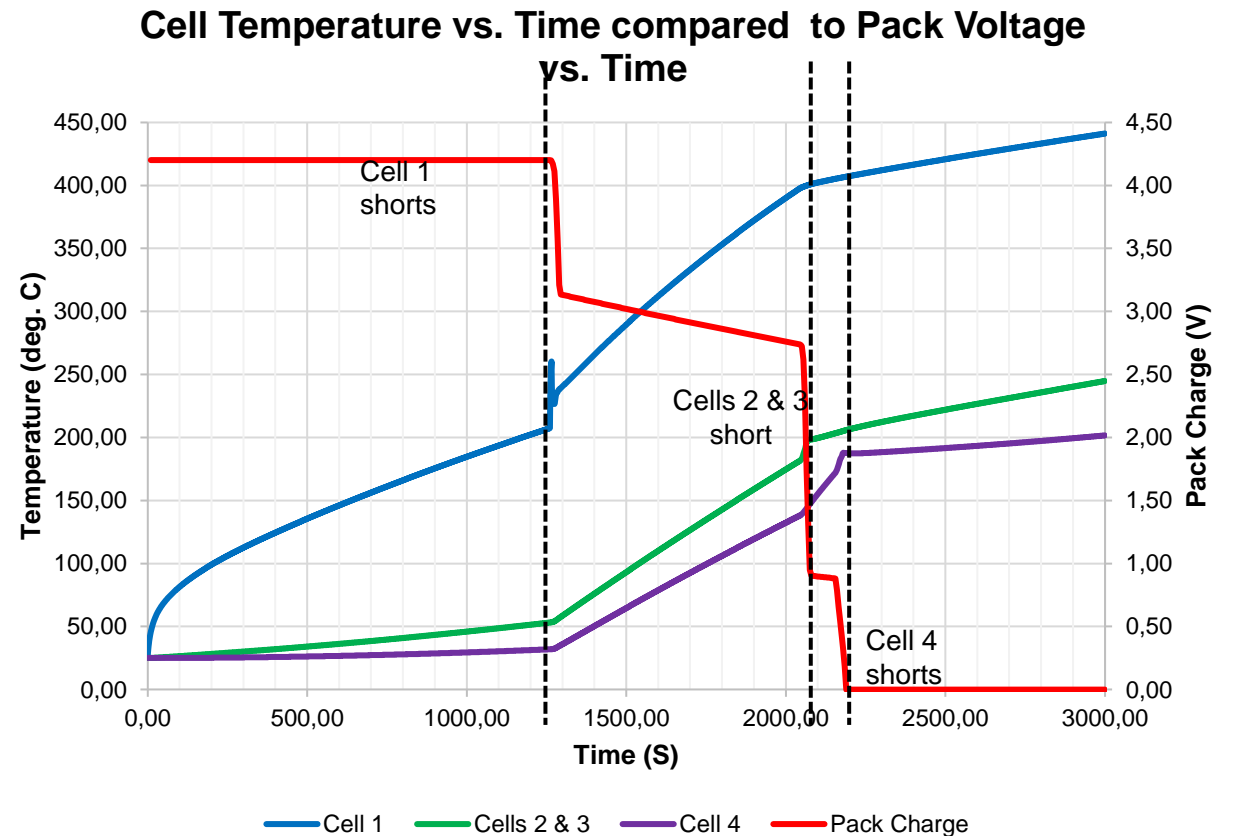
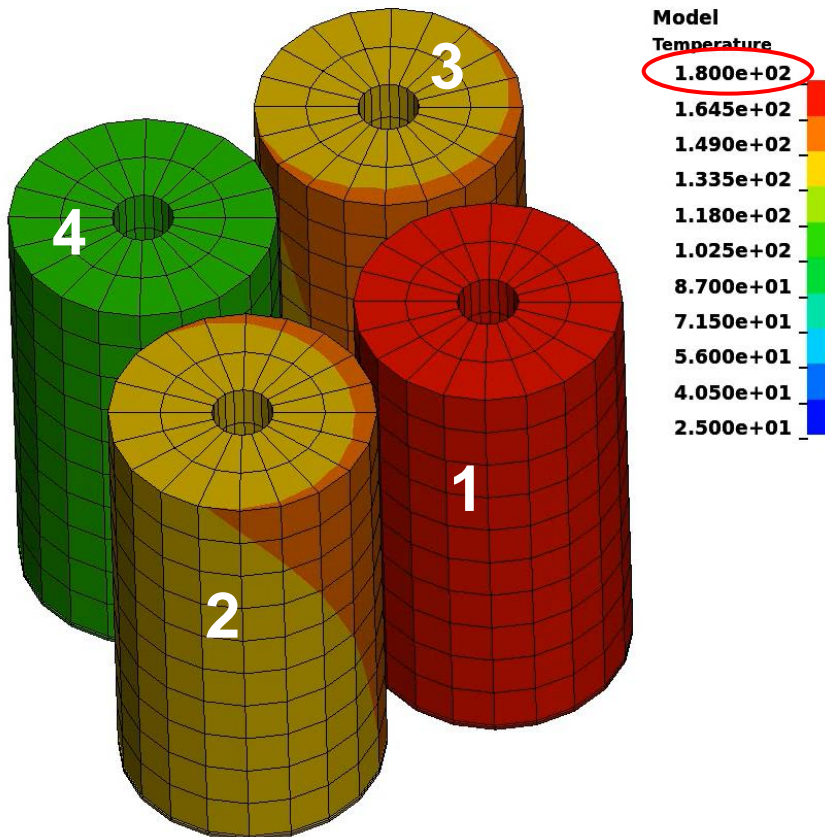

Structural Modul

Models on the microscale

■ Idea: Model all components of the microstructure as they appear

■ Benefits

- Each component can be modeled separately
 - Relatively simple material laws can be applied
 - Failure of each component can be included
- Combination of shells, thick shells and solids possible
- Structural effects from buckling laminate is automatically included

■ Drawbacks

- Element count quickly explodes to unreasonable model sizes
 - Modul or pack simulations are close to impossible
- If layers are allowed to slide, expensive contact modeling needed
- Independent testing of the components needed (tedious)
- Although layers are thin, some solids needed to capture compressibility

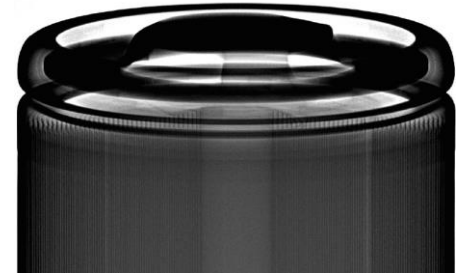

- Separator (shells)
- Negative electrode (solids)
- Positive electrode (solids)
- Neg. current collector (constrained shell in solid)
- Pos. current collector (constrained shell in solid)

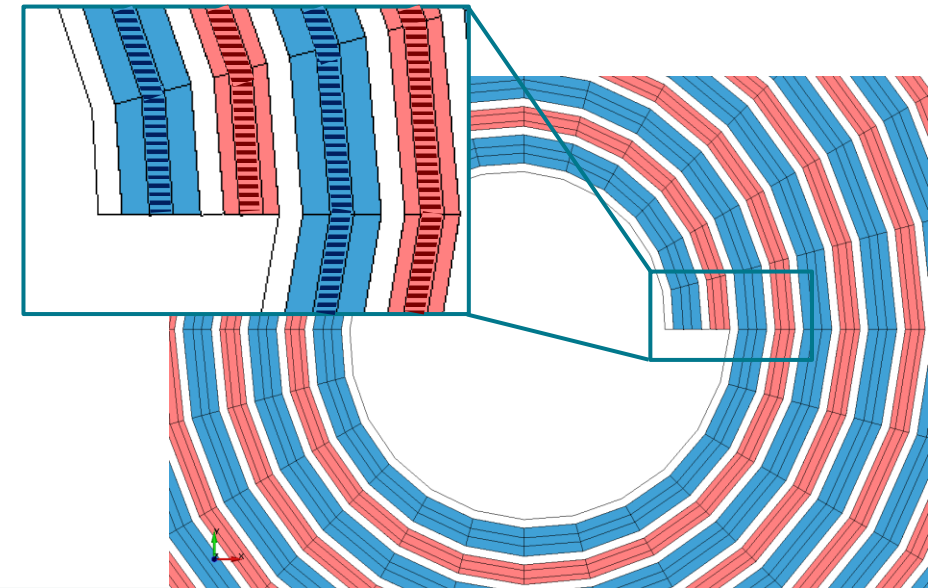

Models on the microscale

■ Simulation results for cylindrical impactor test

- Model size roughly 1.0 mio. elements
 - Elements must be small enough to be able to slide without locking
- Here: All materials are `*MAT_PIECEWISE_LINEAR_PLASTICITY`
 - Currently still based on literature values.
- Goal: Testing and calibration with failure models
 - Isotropic anode and cathode
 - `*MAT_PIECEWISE_LINEAR_PLASTICITY`
 - `*MAT_ADD_EROSION`
 - Anisotropic separator
 - `*MAT_EXTENDED_3-PARAMETER_BARLAT`
 - `*MAT_ADD_GENERALIZED_DAMAGE` (anisotropic failure behavior)

Failure separator → short-circuit

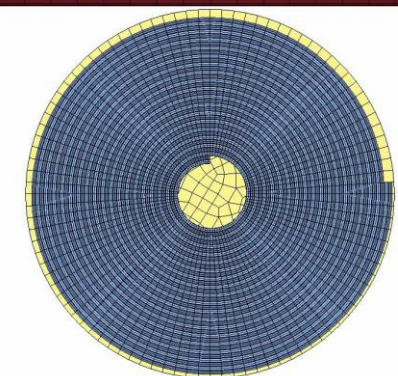
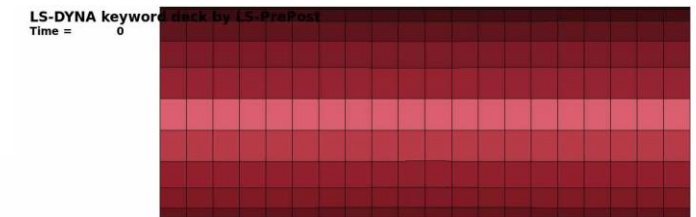
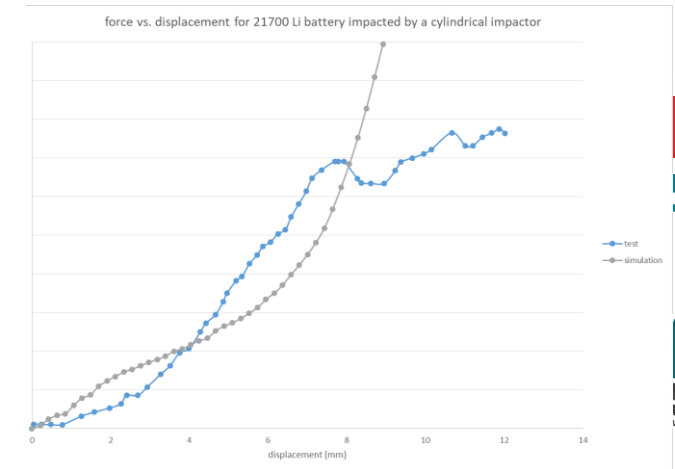
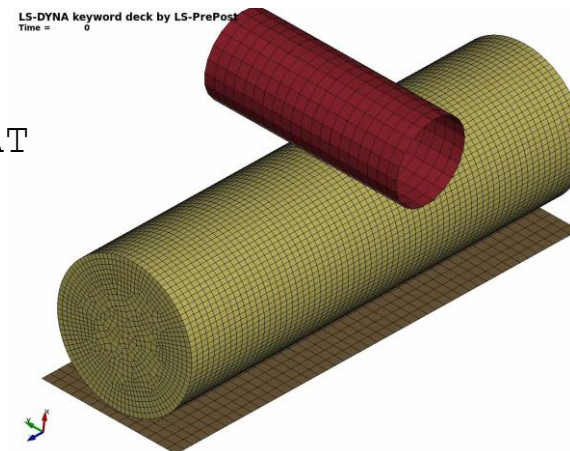

Models on the microscale

■ Simulation results for plate impactor test

- Model size roughly 1 mio. elements
 - Elements must be small enough to be able to slide without locking
- Here: All materials are `*MAT_PIECEWISE_LINEAR_PLASTICITY`
 - Currently still based on literature values.
- Goal: Testing and calibration with failure models
 - Isotropic anode and cathode
 - `*MAT_PIECEWISE_LINEAR_PLASTICITY`
 - `*MAT_ADD_EROSION`
 - Anisotropic separator
 - `*MAT_EXTENDED_3-PARAMETER_BARLAT`
 - `*MAT_ADD_GENERALIZED_DAMAGE`
(anisotropic failure behavior)

Failure separator → short-circuit

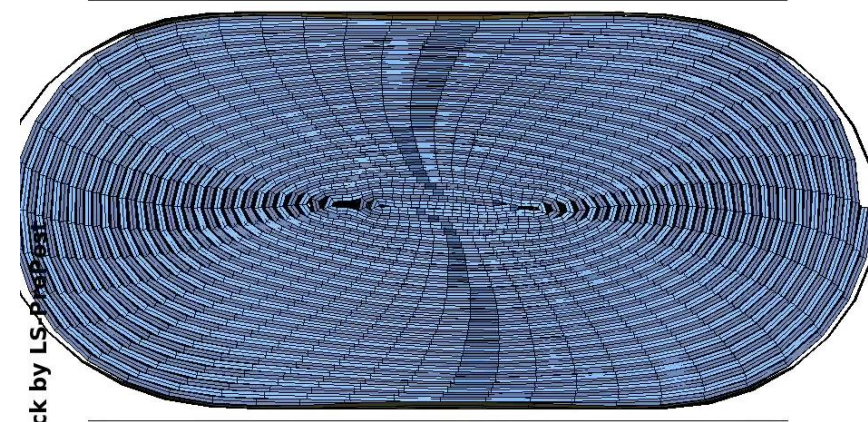
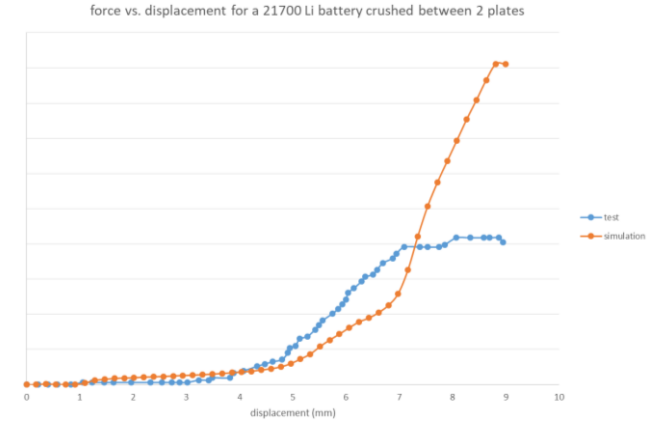

Models on the mesoscale

- Idea: Resolve some of the microstructure but keep element count lower
 - Homogenization of several patterns of layers into one pattern
 - PART_COMPOSITE could be used to represent layers in one homogenized layer
 - How coarse can it get without losing the structural effect or introducing big gaps?

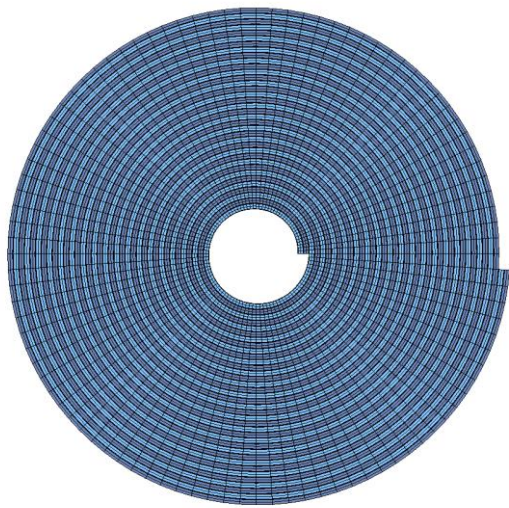

original

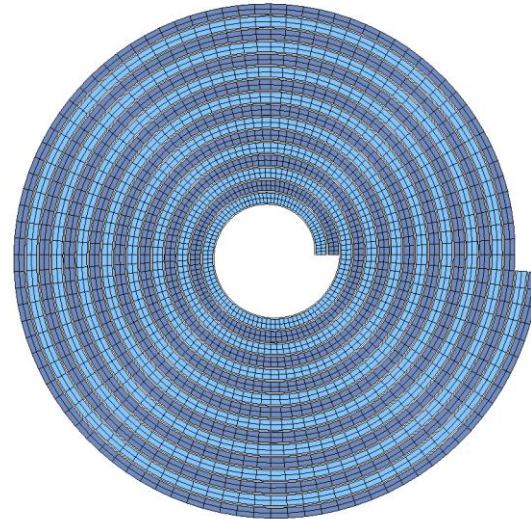

coarse 1

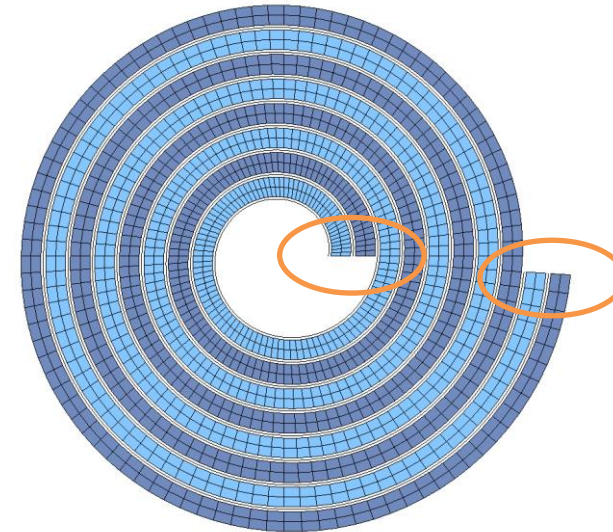

coarse 2a

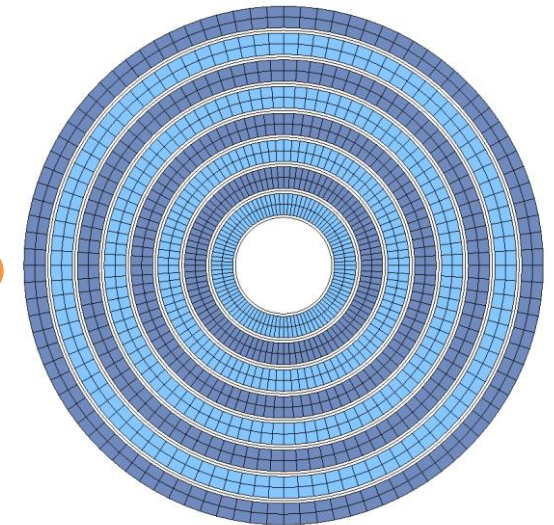

coarse 2b

- Note: Thicker layers introduce higher bending stiffness to the homogenized layer
 - In case of shell elements, this can be compensated by squeezing the z-coordinate of the integration points

Models on the mesoscale

- Extreme case of only one layer in a thin pouch cell
 - Shell elements + discrete beams + airbag model (~1.800 elements)
 - Good representation of the deformation
 - Difficult to predict separator failure

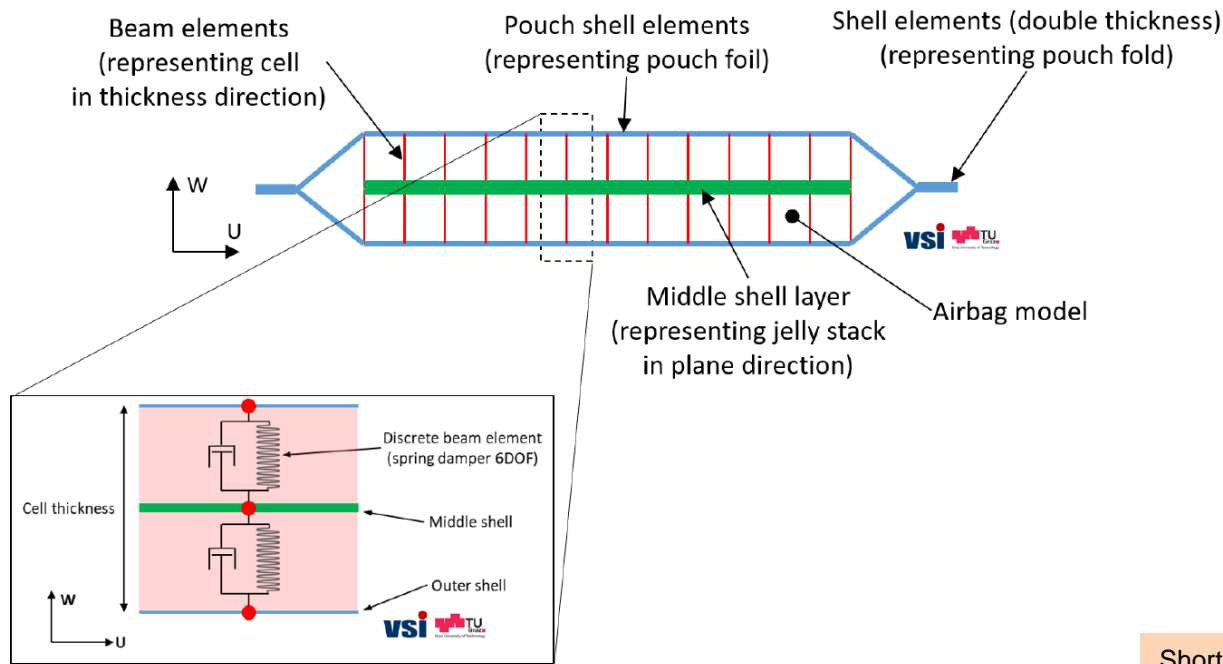

No separator to predict short-circuit

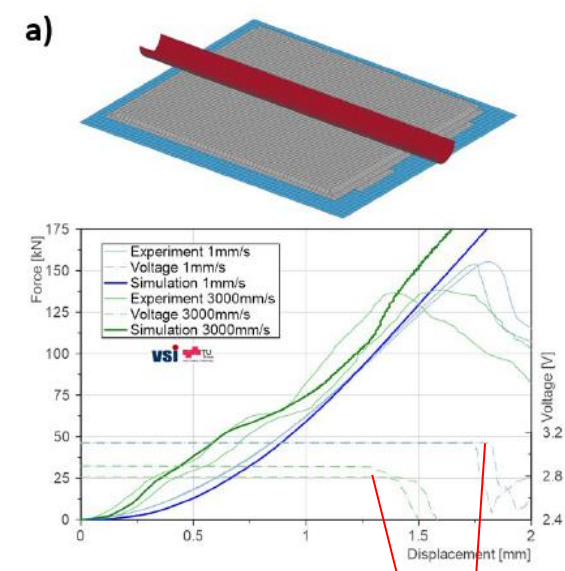

Short-circuit at displacements around 1.3-1.7mm

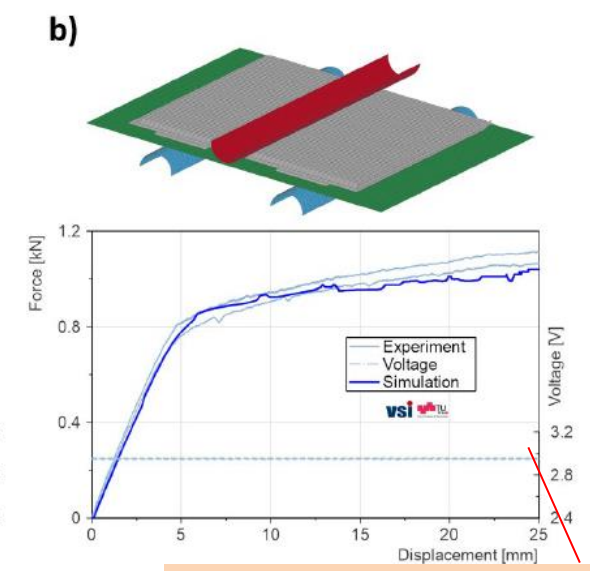

25mm displacements no short-circuit

[Schmid / Uni Graz 2021]

Macro scale models

- Idea: Homogenization over all layers to be able to use much coarser solid elements
 - Typically, all structural effects are ruled out from the model
 - Material models need to include these through the back door
 - Example: `*MAT_MODIFIED_HONEYCOMB`
 - Anisotropic material that allows to decouple normal from shear stresses
 - Three yield surfaces are available
 - The first yield surface defines the nonlinear elastoplastic material behavior separately for normal and shear stresses
 - The second yield surface considers the effects of off-axis loading (transversely isotropic)
 - Because of the definition of the second yield surface, the material can collapse in a shear mode due to low shear resistance
 - There was no obvious way of increasing the shear resistance without changing the behavior in purely uniaxial compression
 - The third yield surface allows to prescribe the shear and hydrostatic resistance without affecting the uniaxial behavior
 - Summary
 - Rather complicated to calibrate
 - Allows to mimic to some degree the sliding of the layers on a solid mesh without internal contact



Macro scale models

- Examples of homogenized models
 - With coupled and decoupled material cards

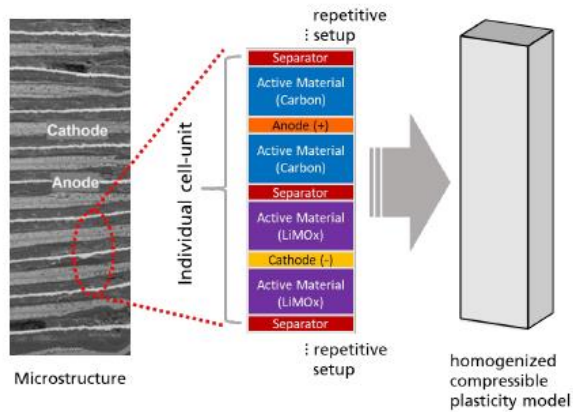

[Trondl / Fraunhofer 2021]

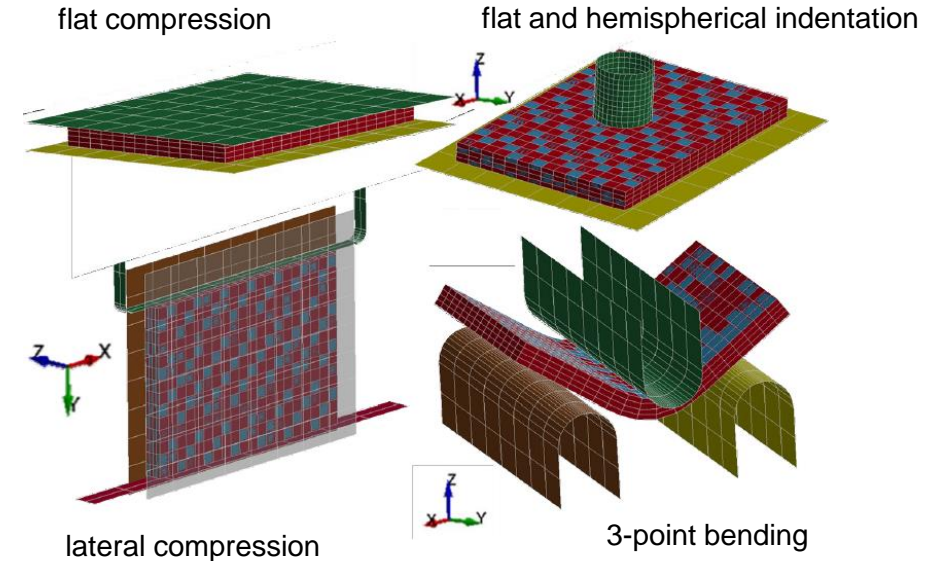

Short circuit areas from experiments
→ relative volume vs. intrusion

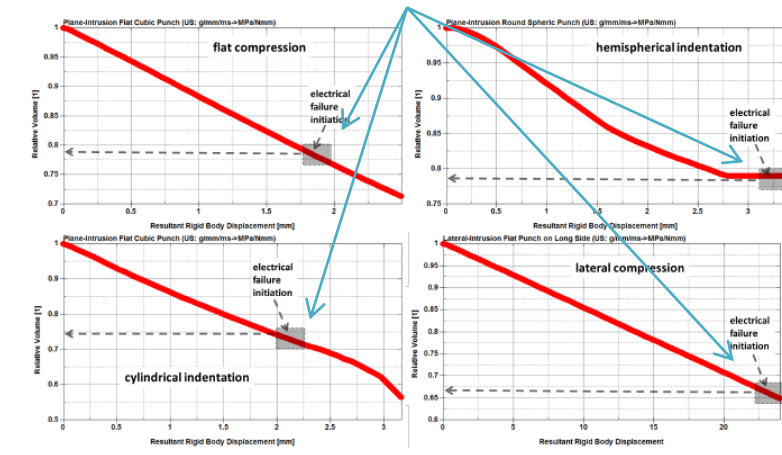
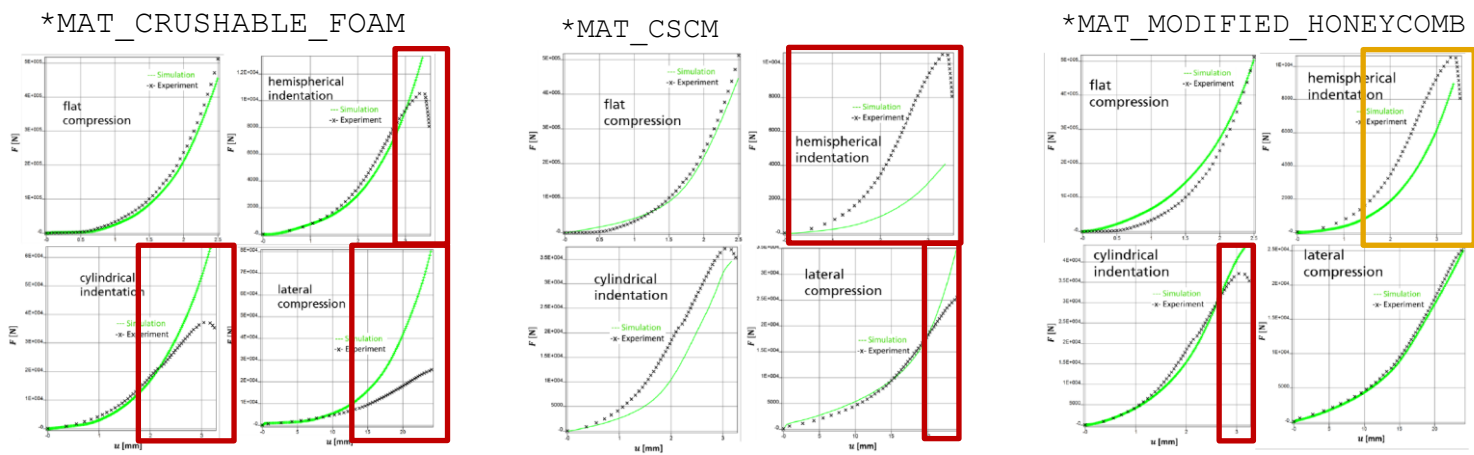

Bringing it all together

Misc. Examples

Download examples from www.dynaexamples.com

Fully coupled simulations

- External short: Solid
 - Conducting rod shorts the tabs of a cell (temperature)

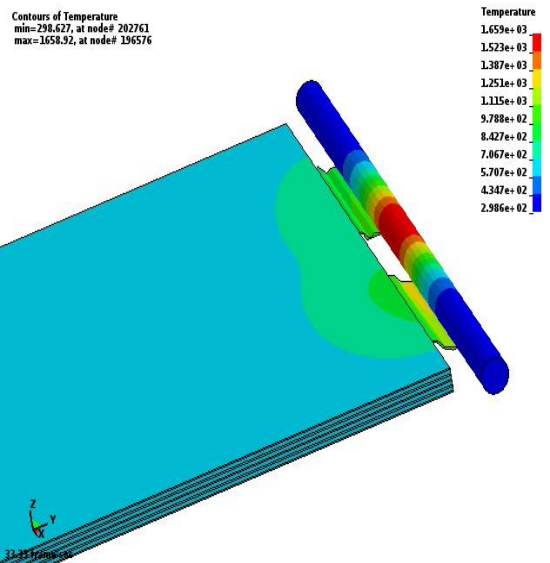

- Internal short: Tshell
 - Sphere impacting a 10-cells module (current density)

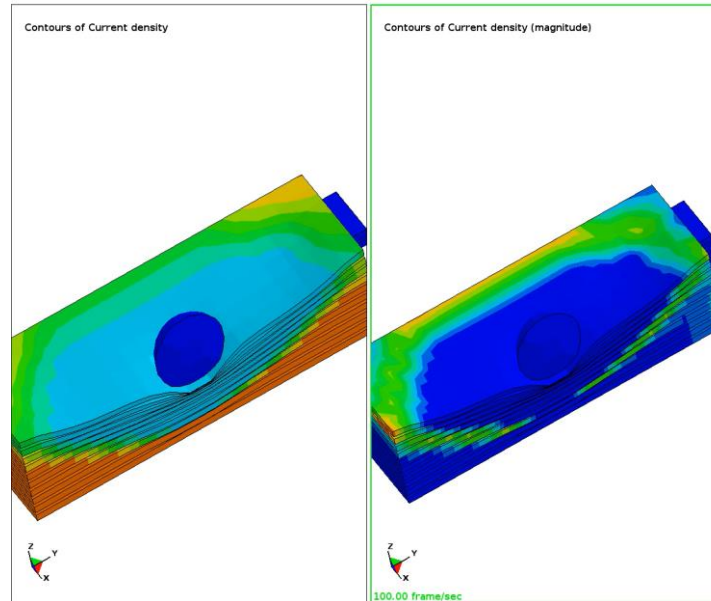

- Internal short: batmac
 - Wall and object impact
 - (Current density + temperature)

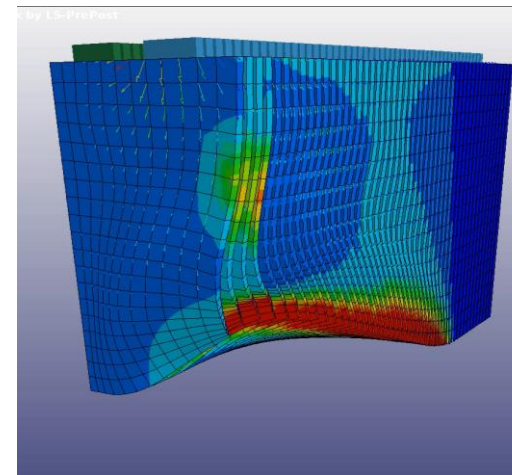

99

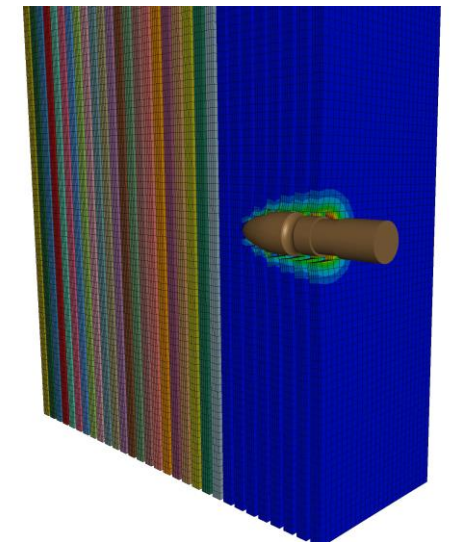

[L'Eplattenier & Çaldichoury 2019]

Time separation strategies

■ Two-step approach

- Crash or impact events usually last less than 100 ms
- From short circuit due to separator failure to thermal runaway can be hours
- Idea: decouple structural simulation from EM-thermo coupled simulation
 1. Do structural only simulation to predict deformation and internal short due to separator failure
 2. Do EM-thermal simulation to predict how battery discharges and if it remains stable

■ Example of a drop test

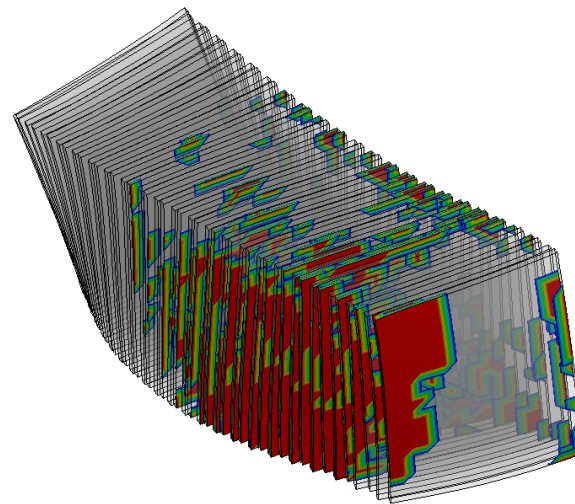
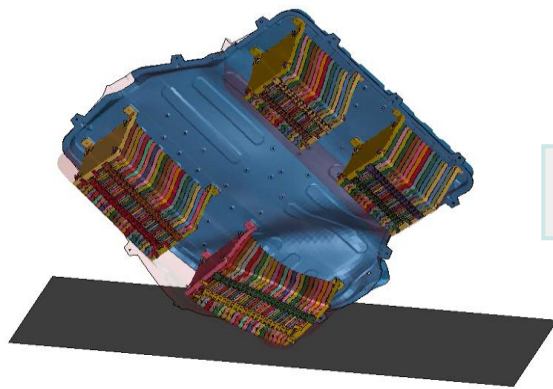

local internal shorts

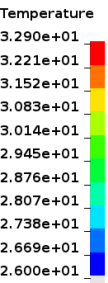
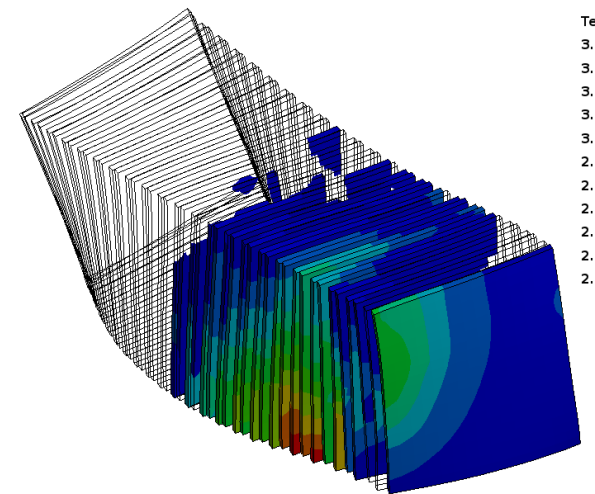
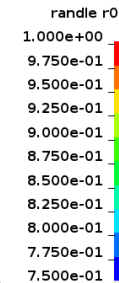

Temperature rise due to resistive heating

[Atri, Nair and Pathy (ANSYS)]

Time separation strategies

■ Extended two-step approach

1. Perform full vehicle crash with macro scale battery models
 2. Replace most critical cell with micro model and redo simulation on sub system
 3. Apply short circuit at location of separator failure and do EM-thermal simulation on frozen geometry
- Requires matching battery models on micro and macro scale

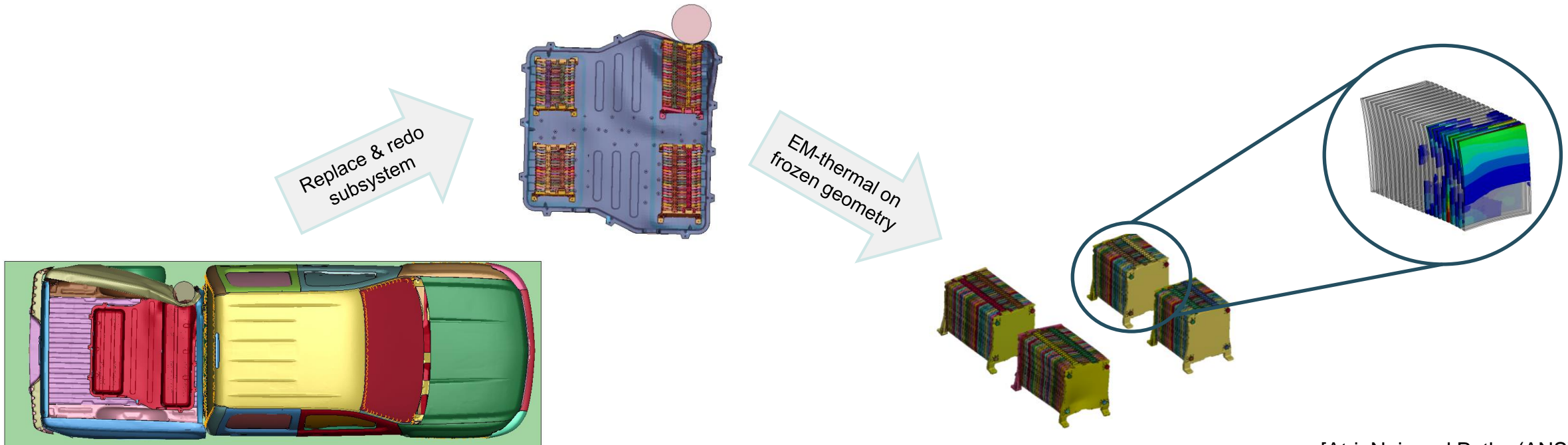

[Atri, Nair and Pathy (ANSYS)]

Conclusion & Future Work

- Successful coupling of the structural and thermal solver with the EM solver
 - Capability to capture the main chain of events
 - Heating triggers internal short, discharge at the shorted area increases temperature, which triggers thermal runaway
 - Heat transfer via contact to neighboring cells included to assess cascading failure in battery packs
 - Different structural models available to predict deformation and on the micro scale even separator failure
 - Coupling to structural solver is possible to capture thermal runaway triggered by shorts due to deformation
- Open questions
 - Thermal boundary conditions
 - Influence of hot vent gases on neighboring cells for the stability of the pack? → CFD simulations needed (e.g., Fluent)
 - Exothermic energy release
 - Is the simple engineering approach enough to capture the complex chemical decomposition?
 - Does it need an extension of the exothermal module to include dependencies on temperature rates and SOC?
 - Mechanical deformation models
 - Best way to predict separator failure in structural simulations

Thank you for your attention!

Questions: nils.karajan@dynamore.com

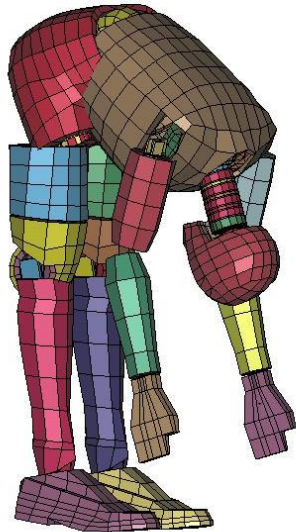

DYNA
MORE

Your LS-DYNA distributor and more



Ansys

Multipurpose simulation tools

Coupled solvers in LS-DYNA

■ Coupled solvers in LS-DYNA

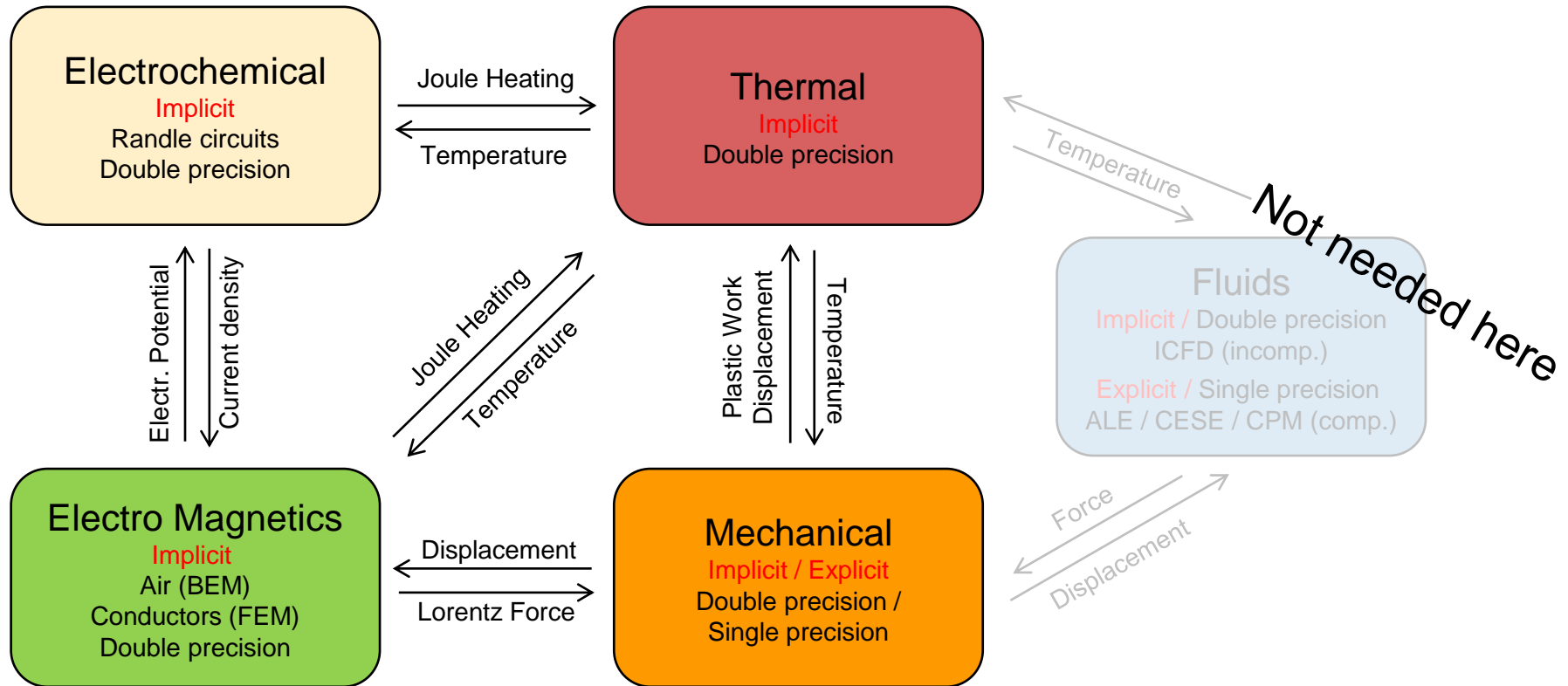

Proof of Concept

■ Cascading cell failure with different heating patch application

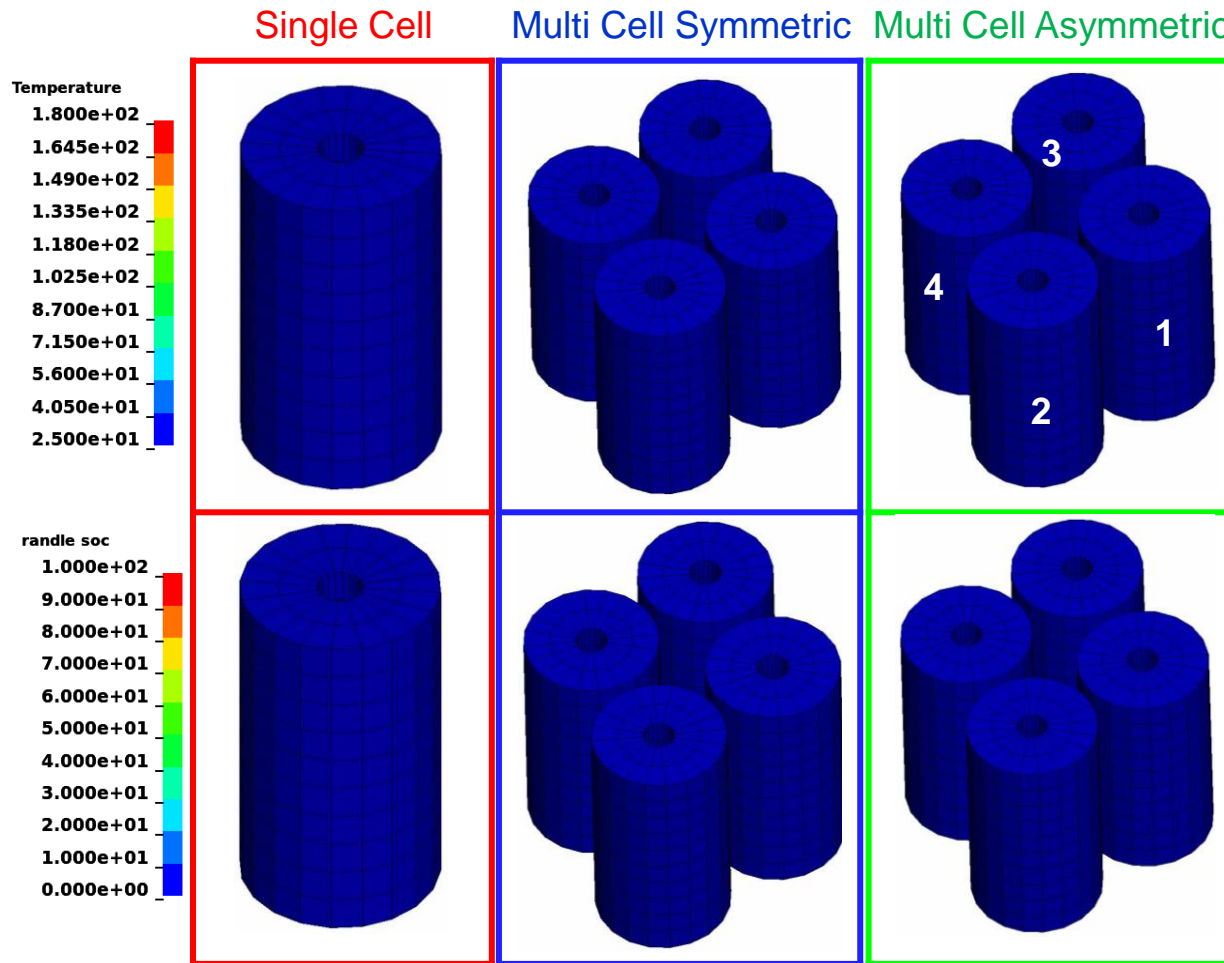

There is a circuit at each node, when the temperature reaches 180 deg. C

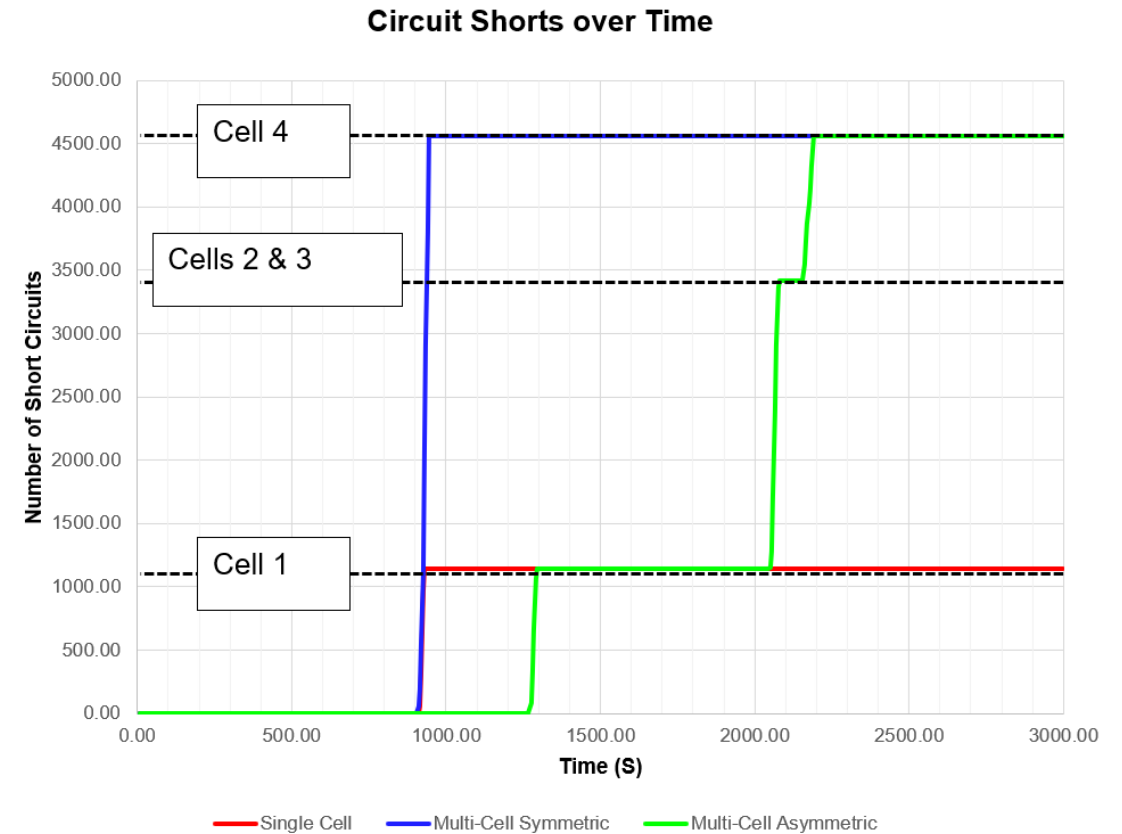

■ Cascading cell failure with different heating patch application

■ Relationship Between Voltage Drop and Temperature Jump

■ Circuit shorts when temperature at the node reached 180 deg. C

□ Here: Thermal convection and radiation boundary not included; different exothermic energy release

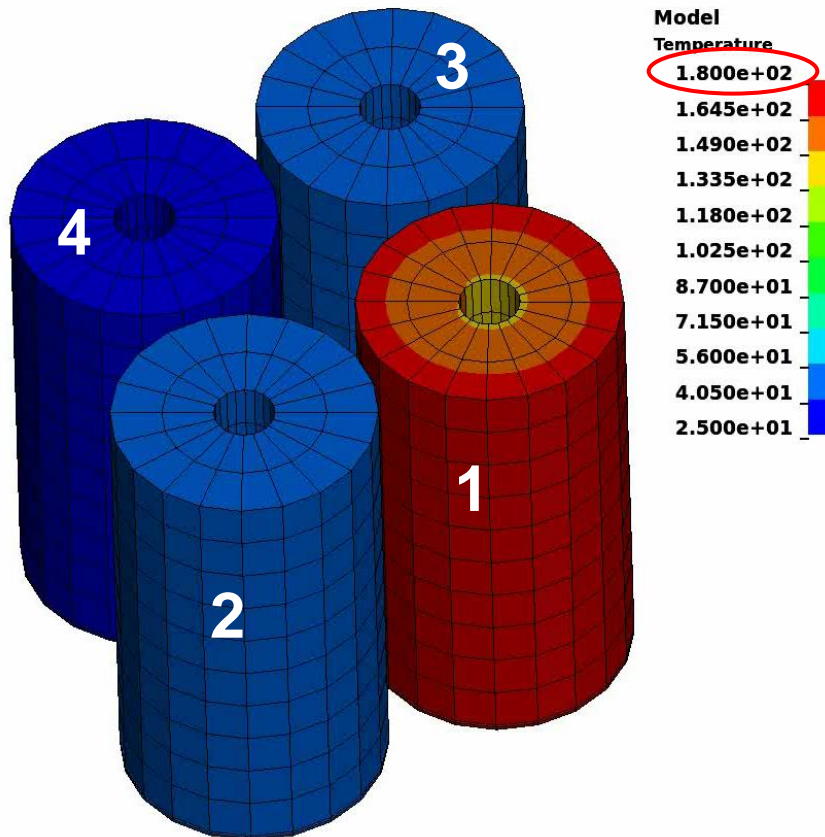

Cell Temperature vs. Time compared to Pack Voltage

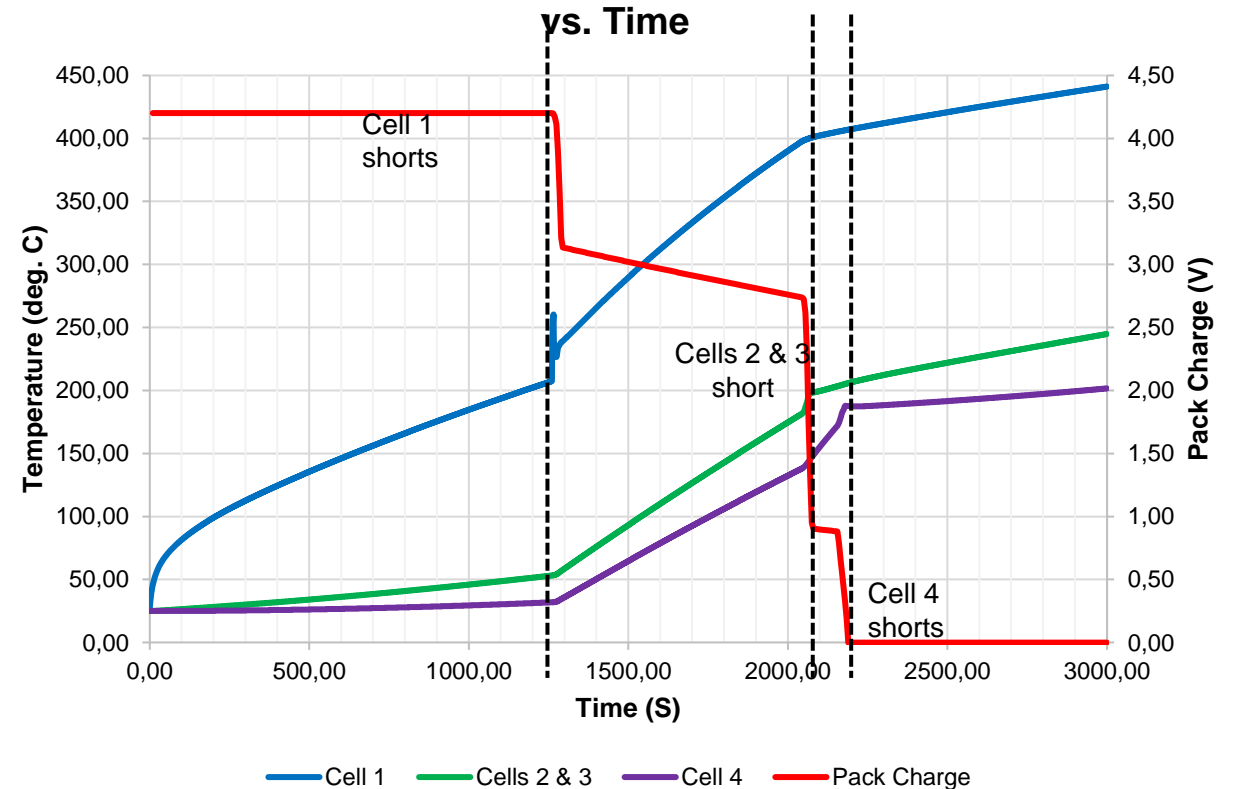

Models on the microscale

- Models can still get refined
 - Model size at around 6 mio. elements
 - Mostly thick shells with more sophisticated material models

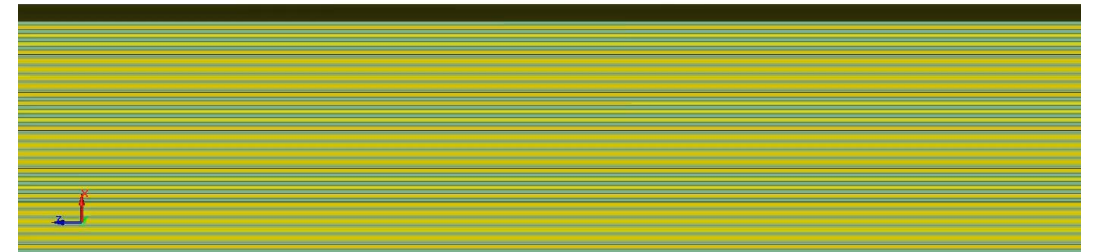
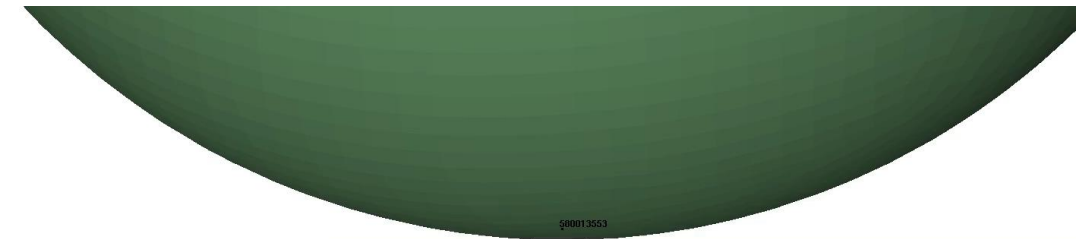
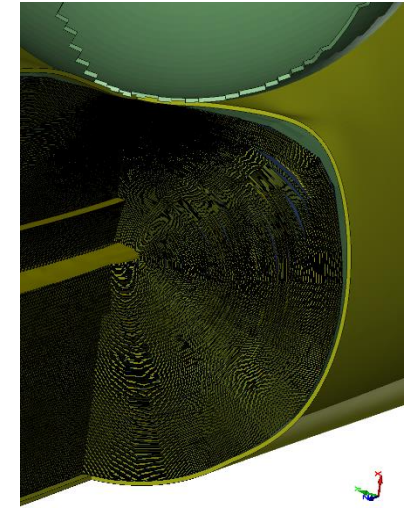
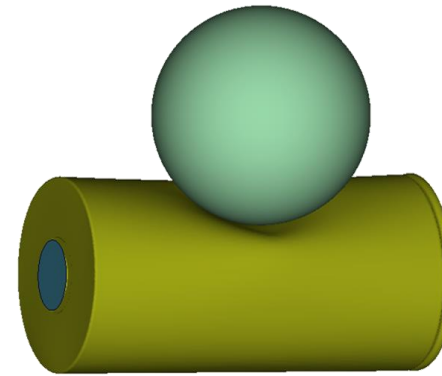
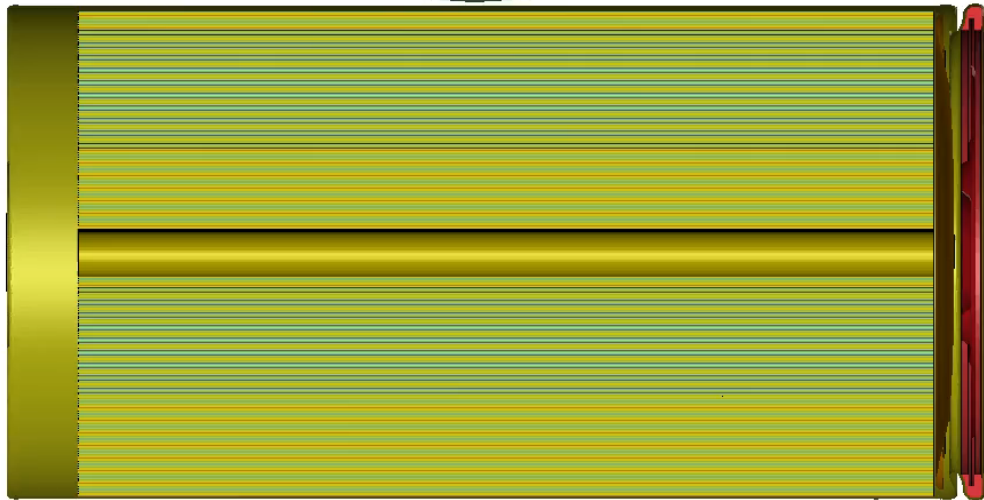
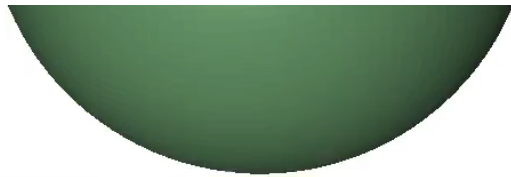

Macro scale models

- Decoupled models seem to be most promising

- Here: *MAT_MODIFIED_HONEYCOMB

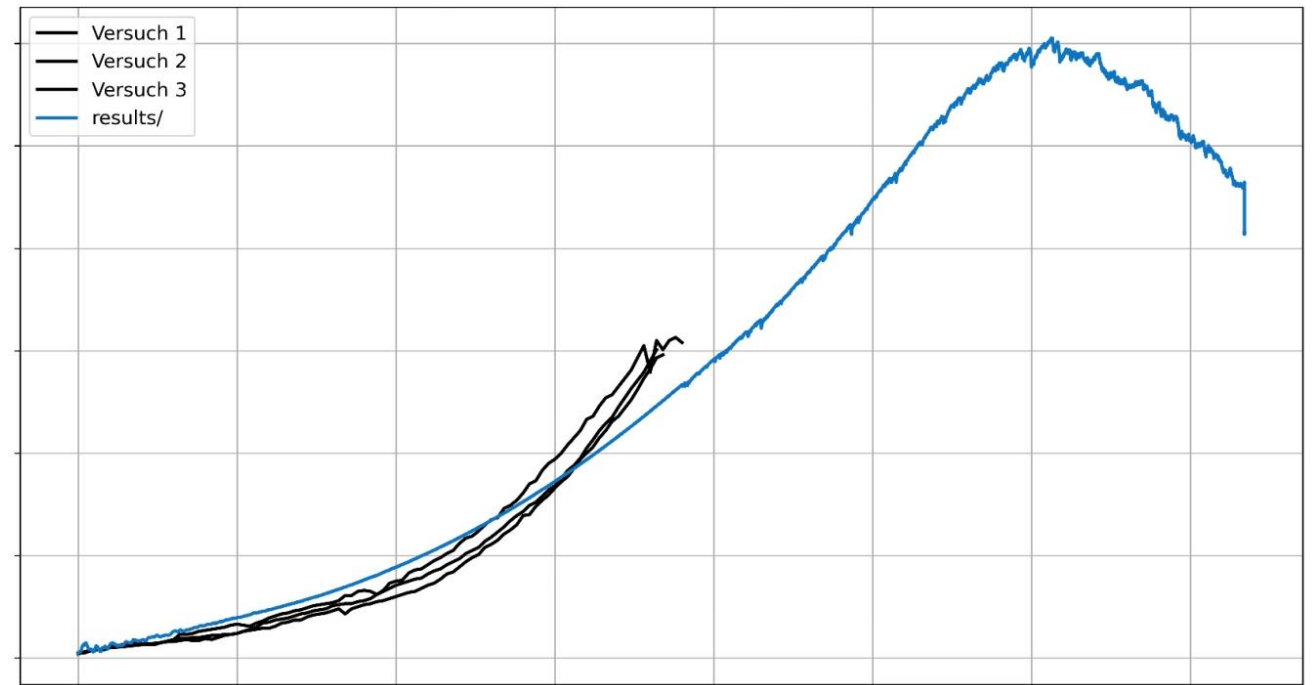
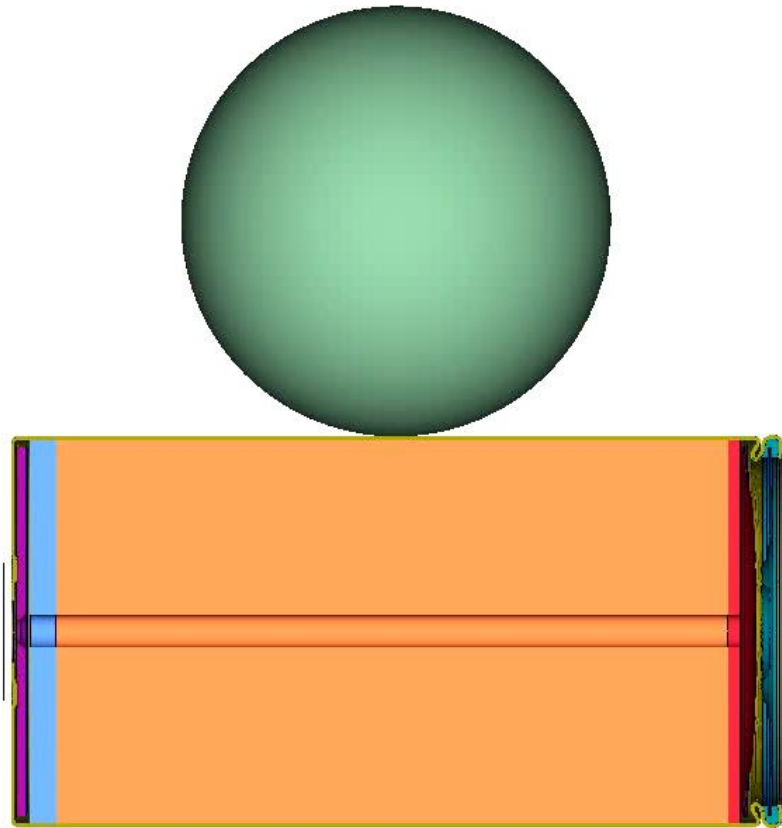
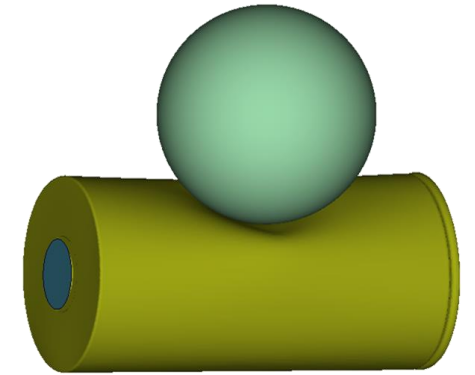

Scale bridging strategies in time

- Sub-cycling to reduce simulation time in explicit simulations
 - Areas with small timestep are computed in 2^n sub cycles
 - Synchronize with other areas every large time step

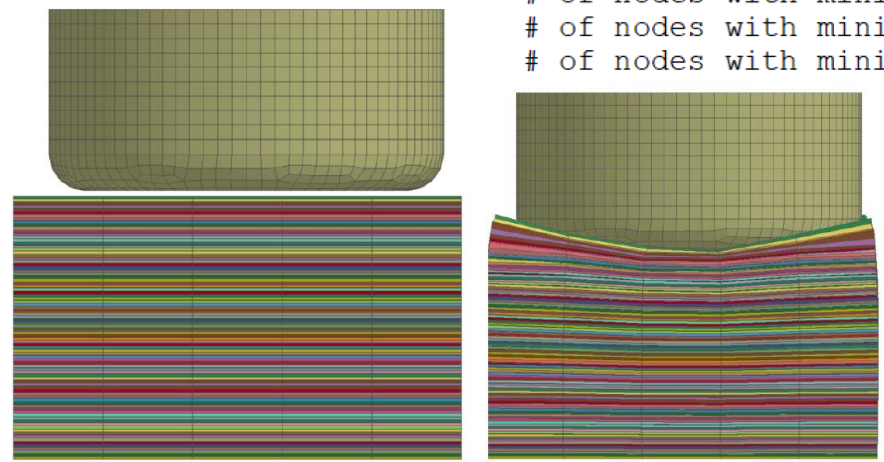
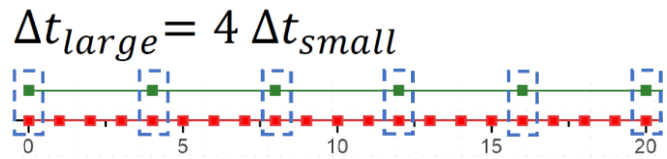
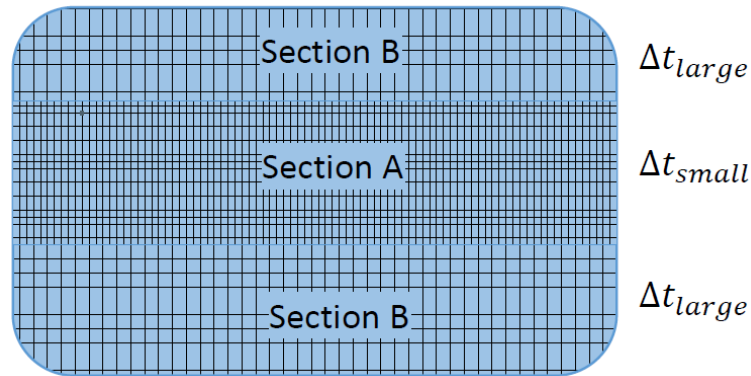

```

minimum time step size      = 0.9639E-05
maximum time step size     = 0.7711E-04
external time step size    = 0.9639E-05
# of nodes with minimum time step size x 1 = 14068
# of nodes with minimum time step size x 2 = 0
# of nodes with minimum time step size x 4 = 864
# of nodes with minimum time step size x 8 = 756
# of nodes with minimum time step size x 16 = 0
# of nodes with minimum time step size x 32 = 0
# of nodes with minimum time step size x 64 = 0
    
```

Simulation time [s] (%)	Local smp_d_R13.0
FULL	697 (100%)
SUBCYCLE_16_1	290 (42%)

[Schmid et al. / SafeLIB / Uni Graz]

Scale bridging strategies in space

■ Data-driven multi-scale modeling

■ Machine learning approach

- Training of the neural network
 - Perform micro-scale analysis on Representative Volume Element (RVE)
 - Homogenization of stress data

- Apply trained neural network
 - Use it as material model on a coarse mesh
 - Will output stress based on an applied strain

- Available in LS-DYNA R13 SMP/MPP
 - *RVE_ANALYSIS_FEM for RVE analysis
 - *DATABASE_RVE for homogenized output

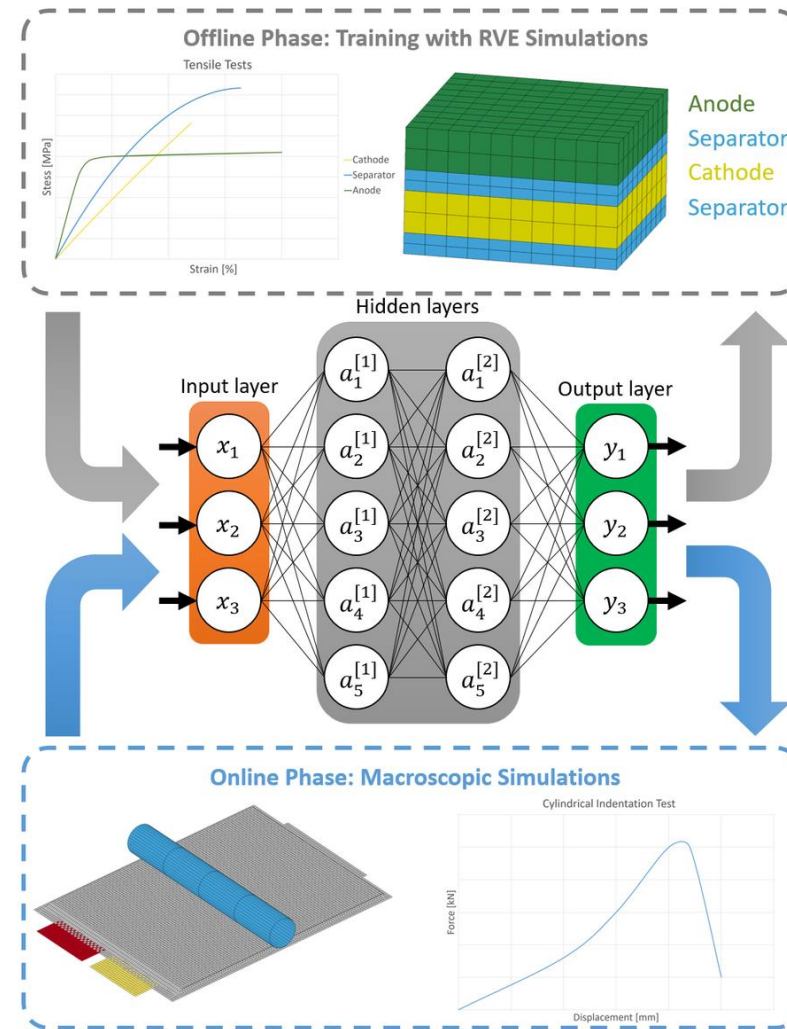

[Schmid et al. / SafeLIB / Uni Graz]

Other challenges around the battery pack

- Deformation chain before the battery needs to be correctly modeled
- Old challenges come back in a different context
 - Extruded aluminum
 - Fiber-reinforced plastics
 - Adhesives, thermal paste
 - Welds
 - Connection to BIW



Audi e-tron Prototyp
Audi e-tron Prototyp
Integrierte Crashstruktur der Lithium-Ionen-Batterie
Integrated crash structure of the lithium-ion battery
04/18



Audi e-tron Prototyp
Audi e-tron Prototyp
Integrierte Crashstruktur der Lithium-Ionen-Batterie
Integrated crash structure of the lithium-ion battery
04/18

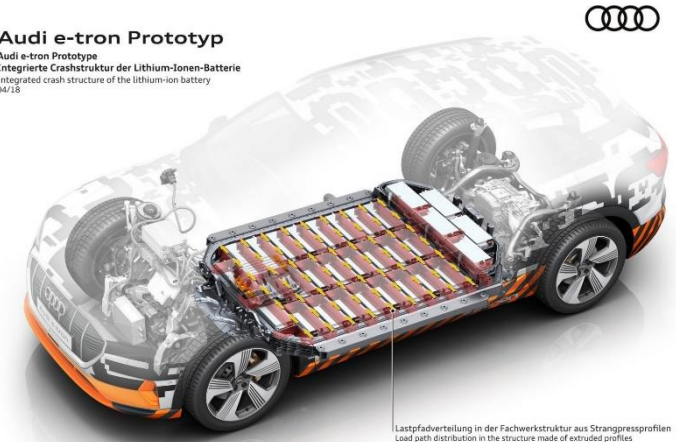

[Courtesy Audi AG]